

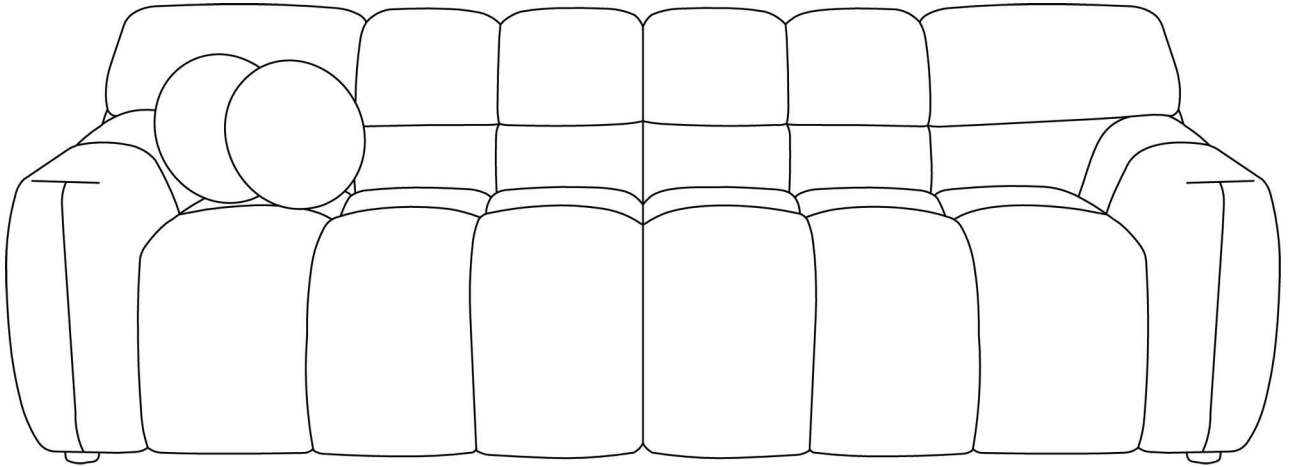

Assembly Instruction

MONICA SOFA

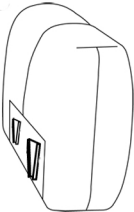

Parts List

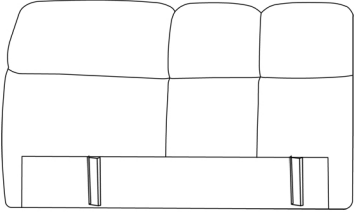
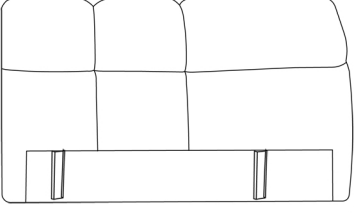
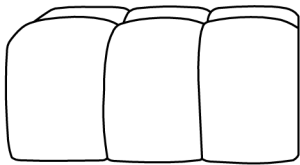
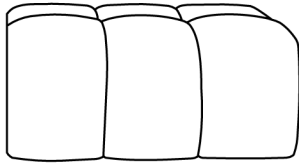
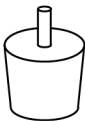
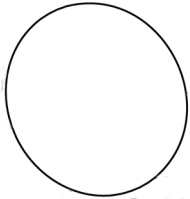
Label	Picture	Descriptio	QTY
A	 A line drawing of a curved armrest with a rectangular base and a small rectangular detail on the side.	Right Armrest	1
B	 A line drawing of a curved armrest, similar to part A but mirrored.	Left Armrest	1
C	 A line drawing of a rectangular backrest with three vertical sections and two horizontal sections, with small rectangular details at the bottom.	Left Backrest	1
D	 A line drawing of a rectangular backrest, similar to part C but mirrored.	Right Backrest	1
E	 A line drawing of a rectangular seat cushion with three vertical sections.	Left Seat	1
F	 A line drawing of a rectangular seat cushion, similar to part E but mirrored.	Right Seat	1
G	 A line drawing of a cylindrical leg with a small vertical post on top.	Leg	12
H	 A line drawing of an oval-shaped pillow.	Pillow	2

Assembly Preparation

Before Beginning
Assembly:

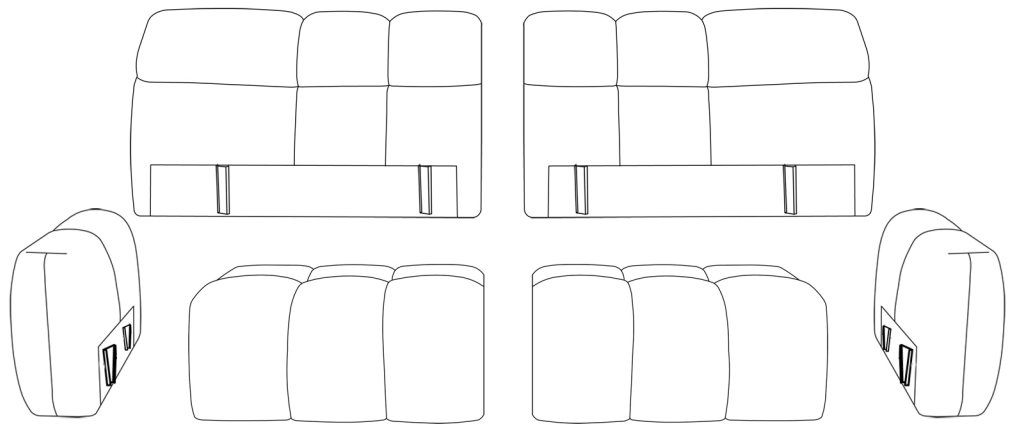

x12

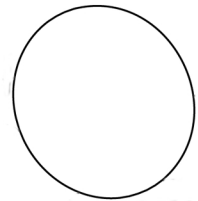

x2



● Read instructions, cover to cover.



● Have 2 adults on hand for assembly.



● Do not assemble on flooring or carpet.

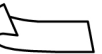

● Assemble on a clean non-marring surface (packing foam).

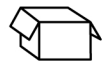

● Save all packaging until finished.

Step 1

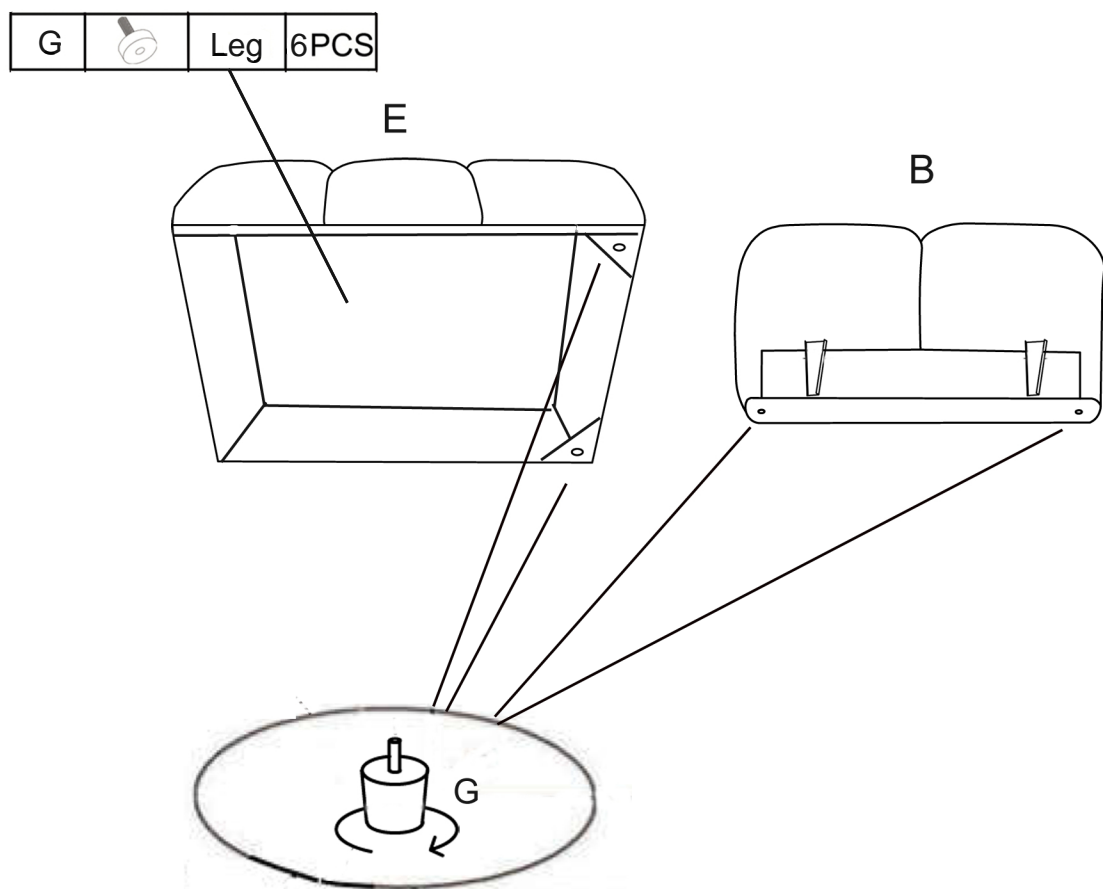
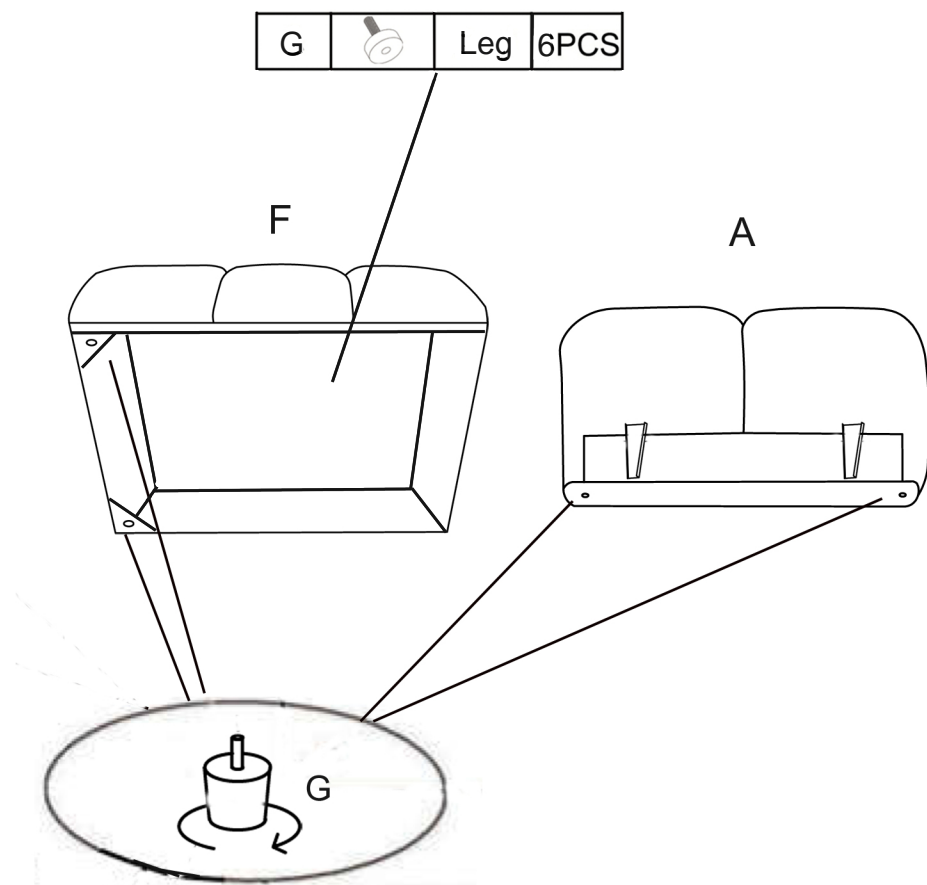

Step2

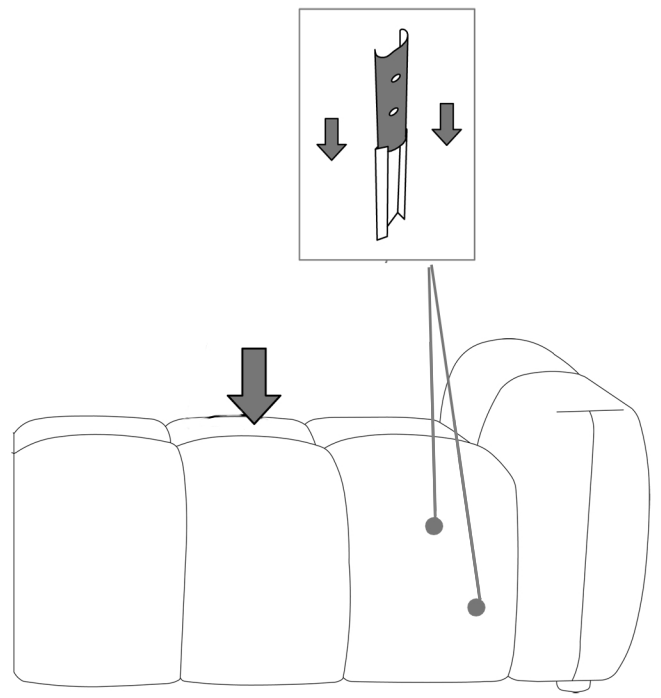
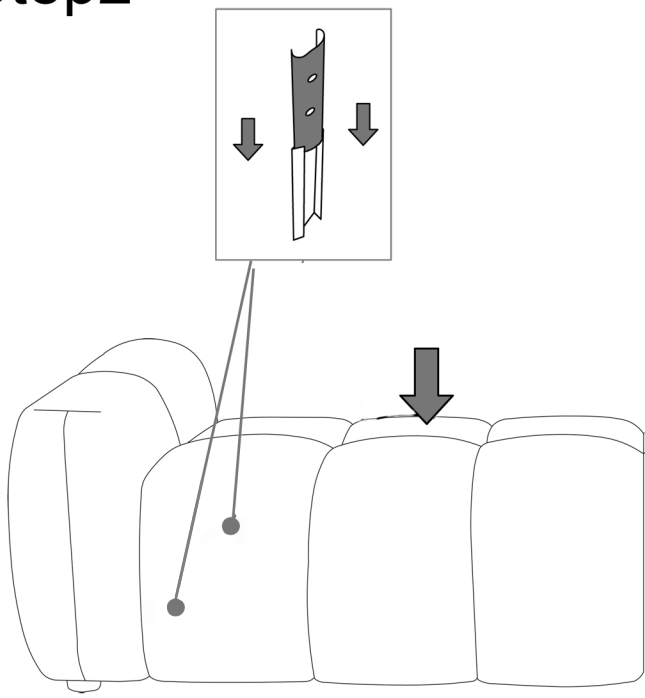

Step3

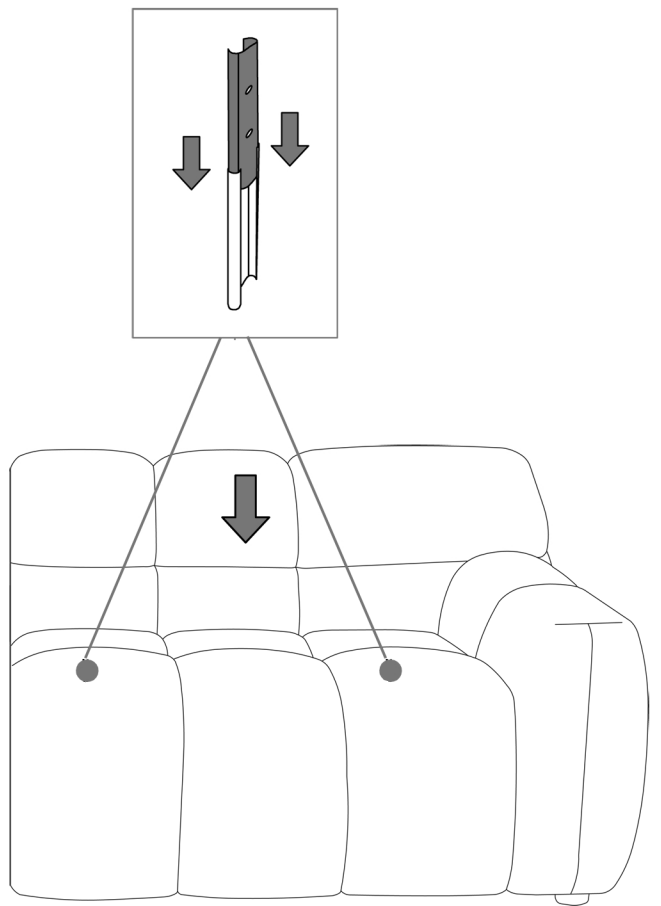
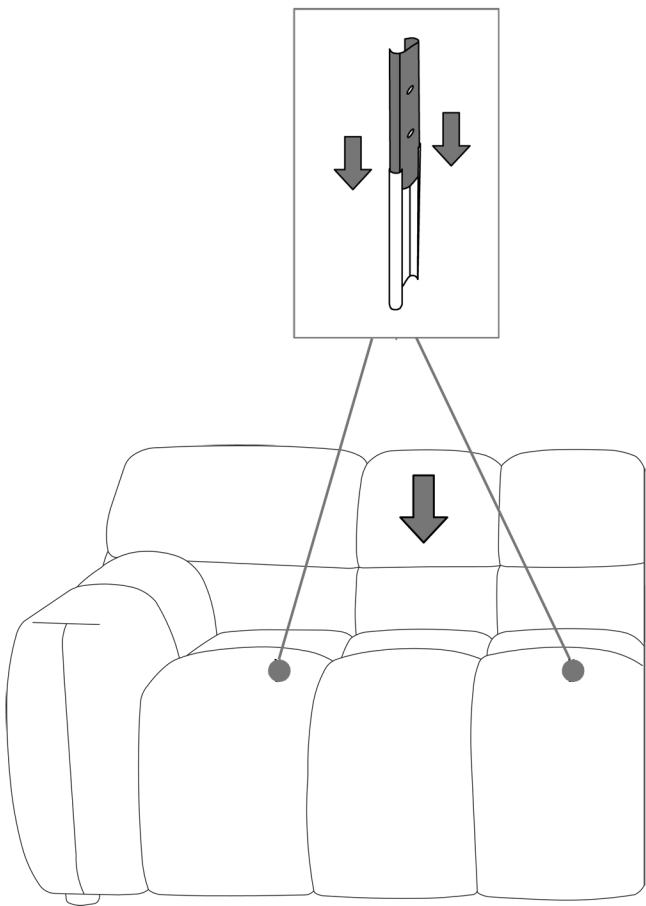

Step 4

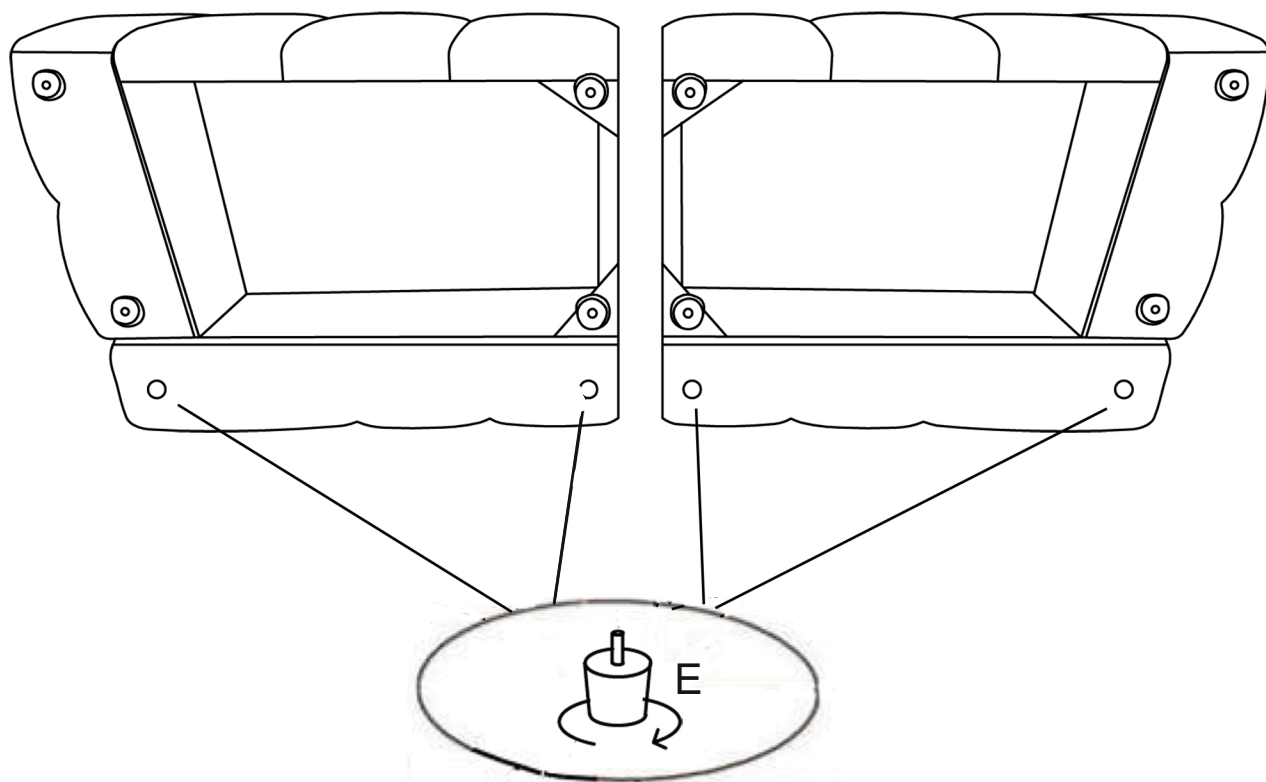

Step 5

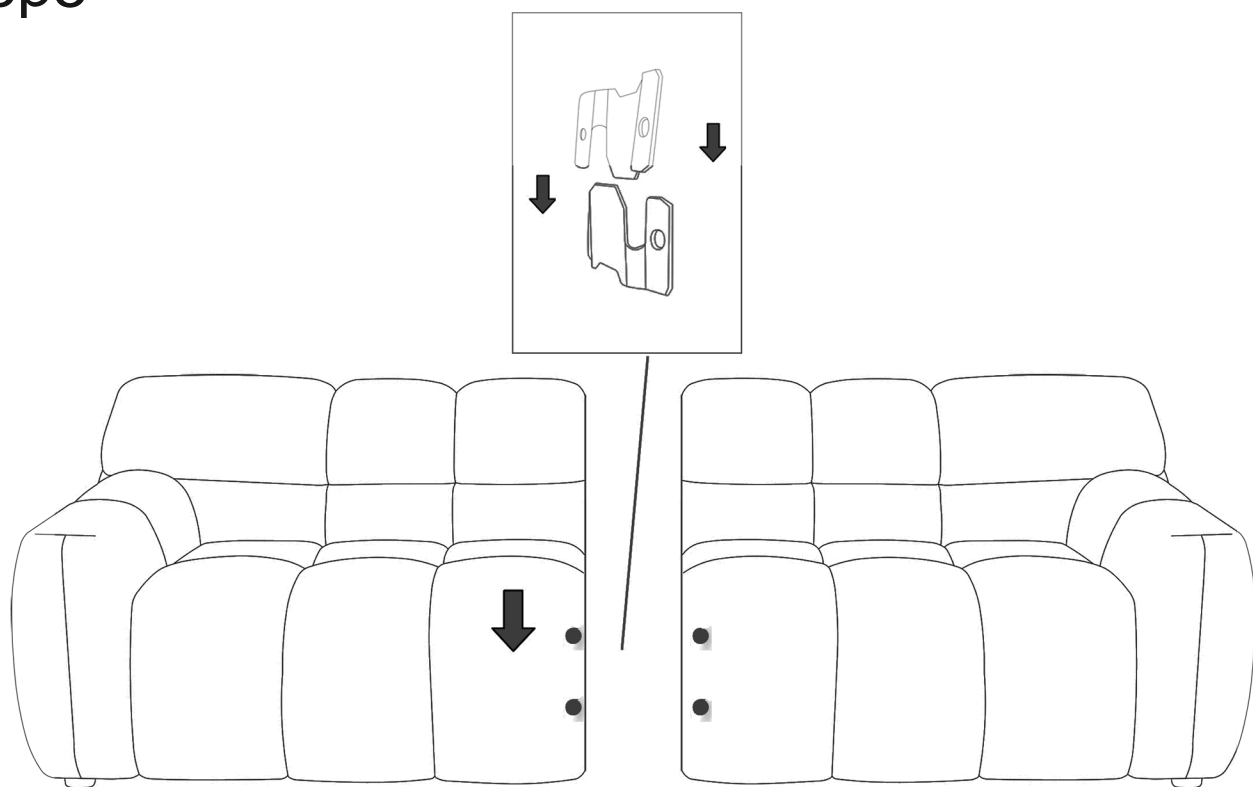

Step6

