

ASSEMBLY INSTRUCTIONS

CAUTION: PLEASE READ ALL INSTRUCTIONS CAREFULLY BEFORE STARTING ASSEMBLY PROCESS. IT IS RECOMMENDED TO USE TWO PEOPLE WHEN ASSEMBLING AND REMOVING THE INSIDE BACKS TO AND FROM THE BASE OF THE FURNITURE.

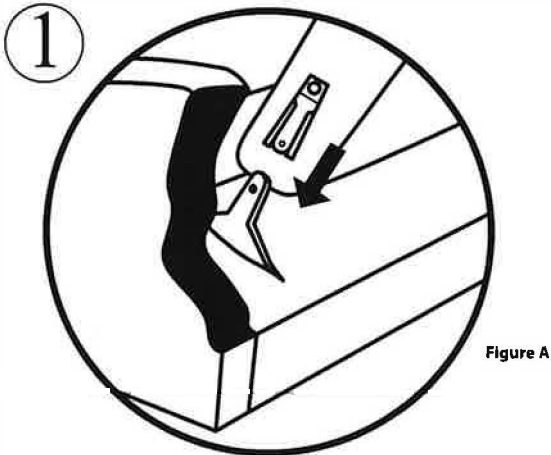

Step 1:

Slide inside back receivers into the steel mechanism posts in the base of the furniture (Figure A).

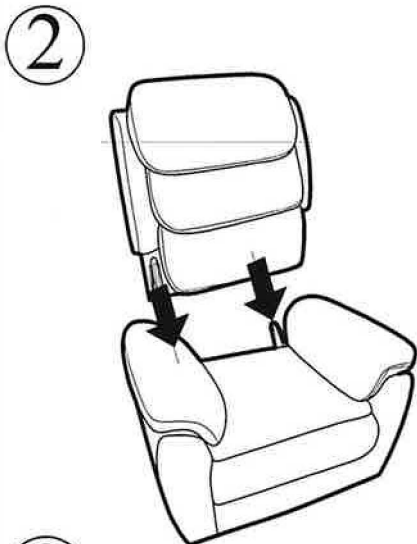

Step 2:

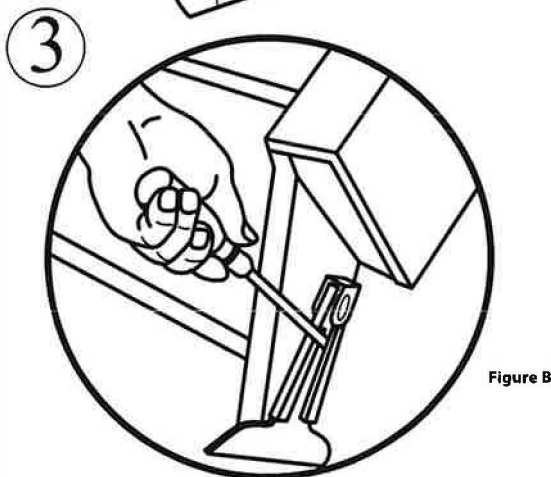

Press both sides of the inside back firmly into place. The inside back automatically locks into place.



Step 3:

To remove the inside backs, use a screwdriver pressing outward on the black tab in the metal sleeve (Figure B) on both sides of the inside back and lift the inside back from the base of the furniture.

PART LIST

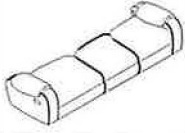
NO.		Q.TY	DESCRIPTION
A		1	LEFT BACKREST
B		1	RIGHT BACKREST
C		1	MIDDLE BACKREST
D		1	BODY

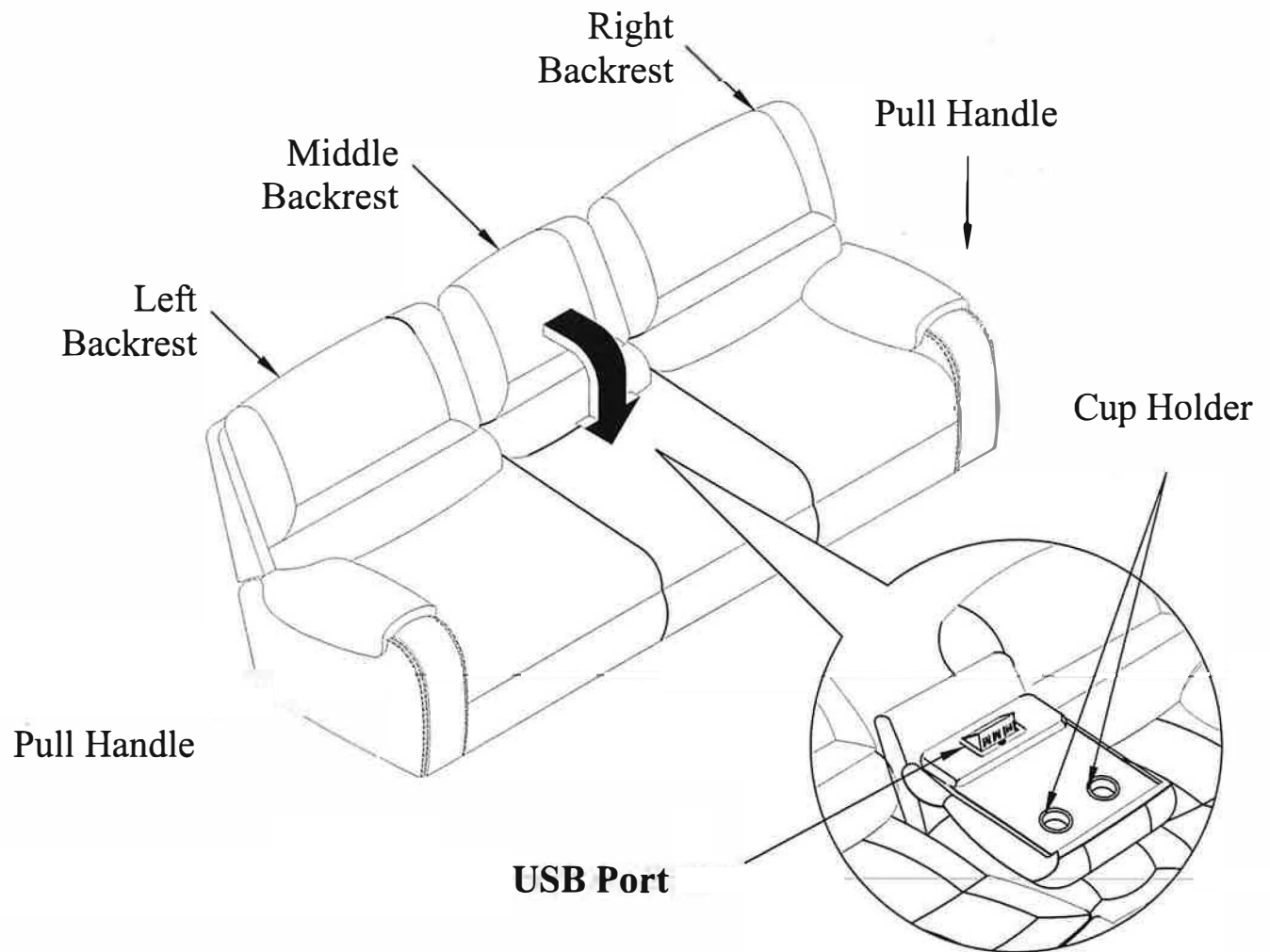

PRODUCT DETAILS

RECLINER CHAIR BODY
 PRODUCT SIZE
 CARTON SIZE
 SEAT HEIGHT
 SEAT DEPTH
 NET WEIGHT
 GROSS WEIGHT
 CU.FT.

ACACIA + PLYWOOD
 W 86" x D 39" x H 41"
 W 87.5" x D 33" x H 29"
 21"
 23"
 234 LBS
 260 LBS
 48.46

Fabric content: 100% PU

This fabric is not machine washable, all +/-3% residual shrinkage.

Do not use cleaning products containing brightening agents.