

Missing Parts? Assembly Questions?





Call us at 1-866-816-3822 or email help@regencyof.com for immediate assistance.

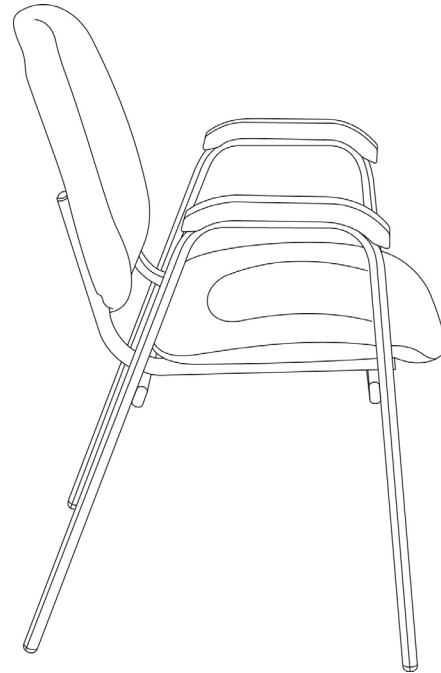
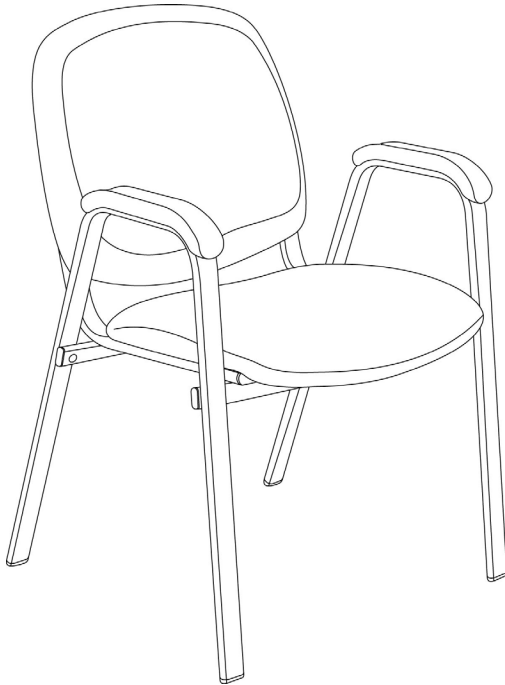

2125LBK
Regency Ace Vinyl Guest Stacking
Chair with Arms

RGS-317LBK
Avery Vinyl Stack Chair

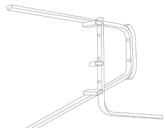
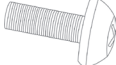
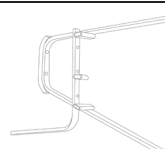
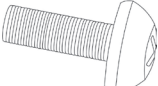

#	Part	Qty	Image	#	Part	Qty	Image
A	Seat	1		E	Curved Support Bar	1	
B	Back	1		F	Front Support Bar	1	
C	Right Side Leg	1		G	Small Bolts	8	
D	Left Side Leg	1		H	Medium Bolts	8	

IMPORTANT NOTICE:

Place all wooden parts on a clean and smooth surface such as a rug or carpet to avoid scratching the parts.
 Check to be sure that you have all parts and hardware.
 Remove all wrapping materials, including staples & packing straps before you start to assemble.
 Keep all hardware parts and packaging out of reach of children.
 Two person assembly recommended.

Product Care and Usage

Thank you for choosing Regency.

This piece of furniture was manufactured by Regency Seating Inc. With minimal care, your furniture will provide you years of quality service. Your satisfaction is important to us. If you need assistance with any of the below instructions, please contact our customer service department at 866-816-9822 or email us at customerservice@regencyof.com.

General

Your furniture should be dusted frequently using a soft, dry, lint-free cloth, dusting with the direction of the wood grain. Do not use chemicals or abrasive materials to clean surfaces. Regency also recommends the use of desk pads/ mouse pads for high use areas to protect finishes.

Care of Laminate/ Wood/ Veneer Surfaces

Gently wipe the surface to remove any surface dust. Clean with a damp cloth and dry with a lint-free cloth. Do not use furniture polish that contains waxes and oils. Do not use bleach-based cleaners on laminate as it may cause discoloration. While laminate is durable and easily cleaned, avoid using hard bristle brushes which may scratch the laminate surface. Avoid sliding objects over the surface to prevent scratching. The use of coasters is recommended to prevent stains from liquids.

Care of Metal Surfaces

Wipe smooth powder coat finishes and textured metals with a damp cloth. For stubborn stains and grease marks, use soap and water.

Care of Leather/ Vinyl Surfaces

Dust only with a clean, dry, lint-free cloth. Do not use polish, wax, or liquid cleaner.

Care of Fabric Surfaces

Regularly clean your fabric with a vacuum or light brush. For spills, use a damp sponge to blot area. Follow up by blotting with a dry, clean towel. Let air dry. Do not rub or scrub. Heat should never be used when cleaning spills or stains. It can cause stains to set and become permanent.

Care of Plastic/ Polypropylene Surfaces

Clean with a mild soap-and-water solution applied to a clean, lint-free cloth. Gently wipe the surface to remove any surface dust. Wipe dry with a new, clean, lint-free microfiber cloth

Care of Hardware

Regularly tighten all nuts, bolts and fasteners. Inspect all joints and fittings to be sure that all are secure. Check and report missing hardware or loose joints.

Step 1: Insert Support Bars (E & F) into Side Legs (C & D). Curved Support Bar (E) goes in the back of the chair, the curve of the Support Bar will face down. Secure using 8 Small Bolts (G).
Note: Do not tighten completely until both sides are secured in place.

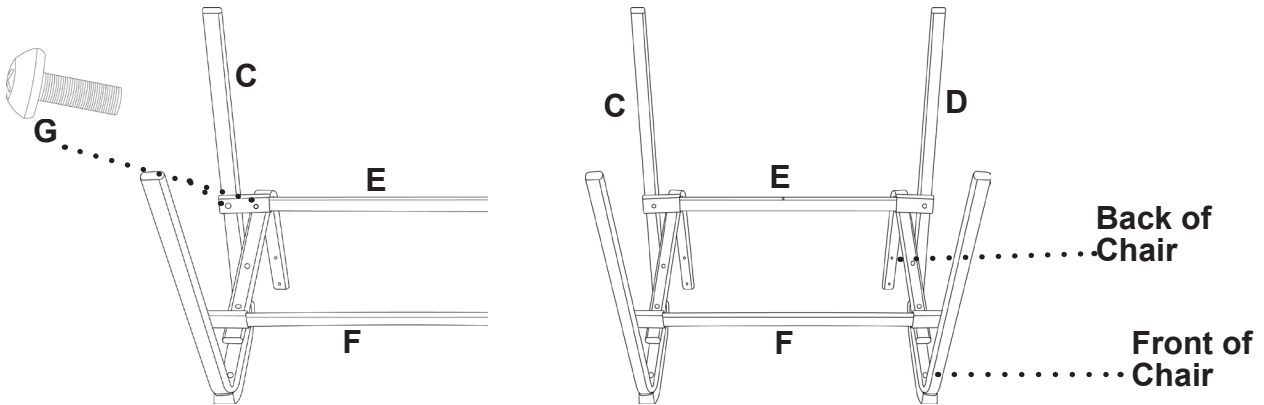

Step 2: Attach Seat (A) to Side Legs (C & D) by using Medium Bolts (H).
Note: Do not tighten bolts until all are in place.

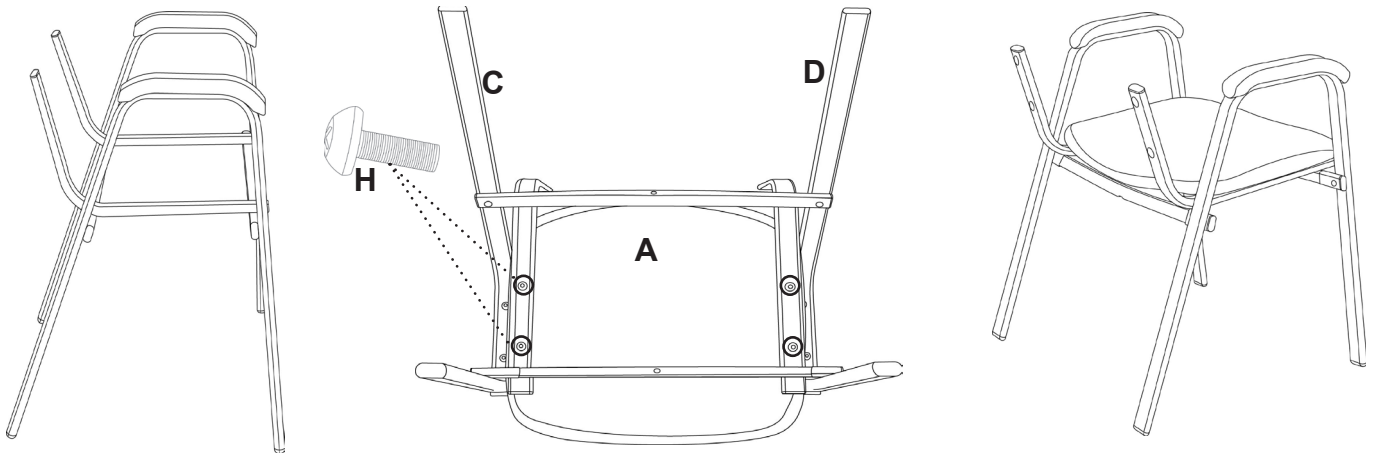

Step 3: Attach Back (B) to Chair Frame/Side Legs (C & D) using Medium Bolts (H).

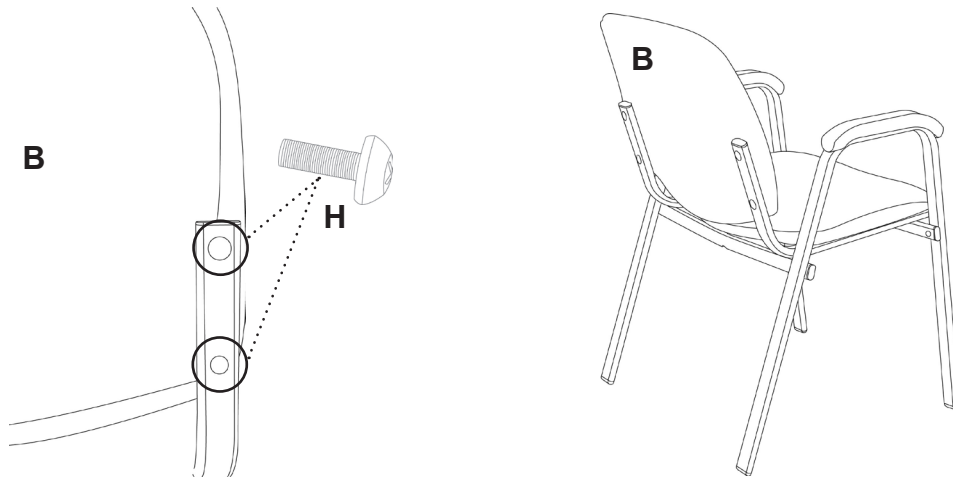



**Thank you for your purchase...
Please be sure to leave a review with your retailer!
We appreciate your feedback!**



Regency Facebook: @RegencyOffice
RGS Facebook: @RGSFurniture



Regency Instagram: regencyof
RGS Instagram: @rgs_furniture



Regency Twitter: @RegencyOFA
RGS Twitter: @RGSFurniture