

Tools Recommended

**EN\_IMPORTANT, RETAIN FOR FUTURE REFERENCE: READ CAREFULLY.**

**FR\_IMPORTANT: A LIRE ATTENTIVEMENT ET À CONSERVER POUR CONSULTATION ULTÉRIEURE.**

**ES\_IMPORTANTE, LEA Y GUARDE PARA FUTURAS REFERENCIAS.**

**PT\_IMPORTANTE, RETER PARA REFERÊNCIA FUTURA: LEIA ATENTAMENTE.**

**DE\_WICHTIG! SORGFÄLTIG LESEN UND FÜR SPÄTER NACHSCHLAGEN AUFBEWAHREN.**

**IT\_IMPORTANTE! CONSERVARE IL PRESENTE MANUALE PER FUTURO RIFERIMENTO E LEGGERLO ATTENTAMENTE.**

**BOX  
1-2**

**1** 1PC



**2** 1PC

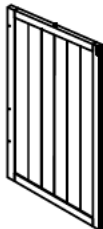

**3** 1PC

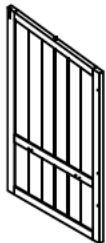

**4** 1PC



**7** 1PC



**8** 1PC



**9** 1PC



**10** 1PC





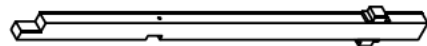

**12** 1PC

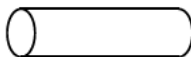

**13** 1PC



<b>A</b>		2PCS
<b>B</b>		4PCS+1
<b>C</b>	 <b>3.5*45</b>	8PCS+1
<b>D</b>	 <b>3.5*35</b>	23PCS+2
<b>E</b>	 <b>3.5*30</b>	28PCS+2
<b>F</b>	 <b>3*16</b>	32PCS+2

**BOX  
2-2**

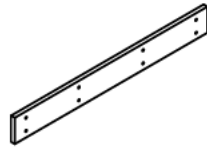

**5** 2PCS

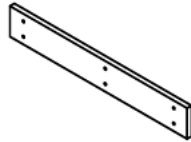

**6** 2PCS

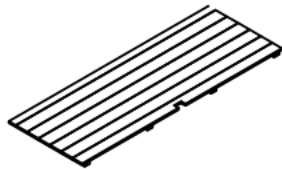

**11** 1PC

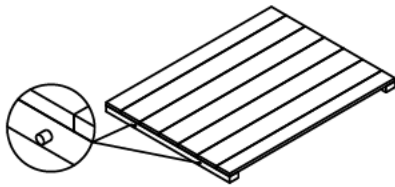

**14** 2PCS

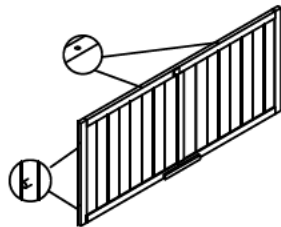

**15** 1PC

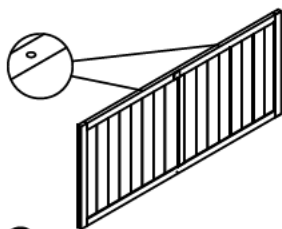

**16** 1PC



**17** 1PC

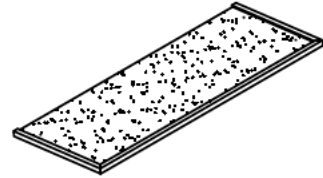

**18** 1PC

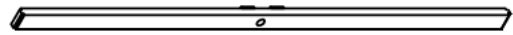

**19** 1PC

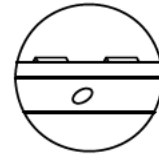

**20** 1PC

**EN**

**Dear customer,**

Thank you for purchasing this product. So that your appliance serves you well, please read all the instructions in this user's manual. If you have any questions, please contact our customer care center, Our contact details are below:

**FR**

**Cher client,**

Nous vous remercions d'avoir acheté ce produit. Afin que vous puissiez profiter pleinement de votre appareil, veuillez lire toutes les instructions de ce manuel d'utilisation. Si vous avez la moindre question, veuillez contacter notre centre d'assistance à la clientèle, Nos coordonnées sont les suivantes:

**DE**

**Sehr geehrter Kunde,**

Vielen Dank, dass Sie dieses Produkt erworben haben. Damit Ihr Gerät Ihnen gute Dienste leistet, lesen Sie bitte alle Hinweise in diesem Benutzerhandbuch. Wenn Sie Fragen haben, wenden Sie sich bitte an unser Kundendienstzentrum, Unsere Kontaktdaten stehen unten:

**ES**

**Queridos clientes,**

Gracias por comprar este producto. Para que su electrodoméstico le sirva mejor, lea todas las instrucciones de este manual del usuario. Si tiene alguna pregunta, comuníquese con nuestro Centro de Atención al Cliente, Nuestros datos de contacto son los siguientes:

**PT**

**Caros clientes,**

Obrigado por adquirir este produto. Para que o seu aparelho o sirva melhor, leia todas as instruções deste manual do utilizador. Se tiver alguma dúvida, por favor contacte o nosso Centro de Atendimento ao Cliente, Os nossos dados de contacto são os seguintes:

**IT**

**Caro Cliente,**

Grazie per aver acquistato questo prodotto. Per servirti meglio con questo apparecchio ti prego di leggere tutte le istruzioni in presente manuale utente. In caso di dubbio, si prega di contattare il nostro centro assistenza clienti, I nostri dettagli di contatto sono di seguito:

① x01

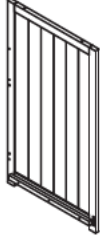

⑧ x01



② x01

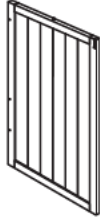

⑨ x01



③ x01



⑩ x01



④ x01



⑪ x01

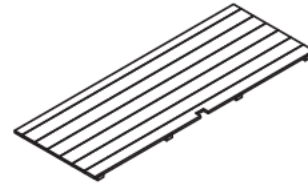

⑤ x02

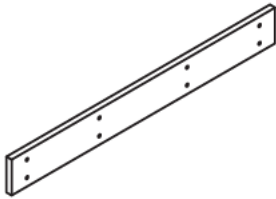

⑫ x01



⑥ x02

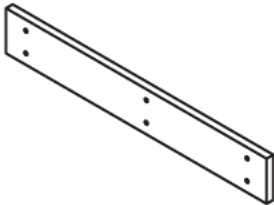

⑬ x01



⑦ x01



⑭ x02



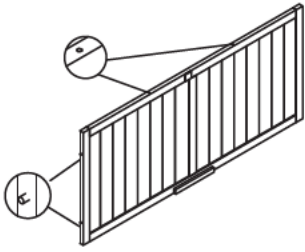

15 x01

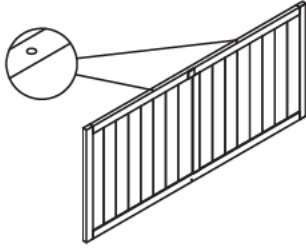

16 x01



17 x01

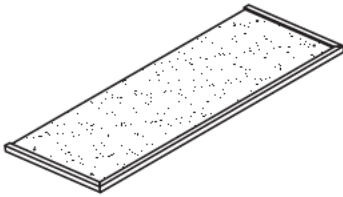

18 x01



19 x01

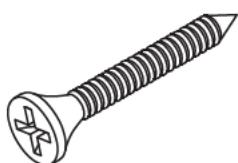

20 x01

**A** x02**B** x04+1(spare)**C** x08+1(spare)

M3.5\*45

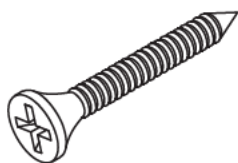
**D** x23+2(spare)

M3.5\*35

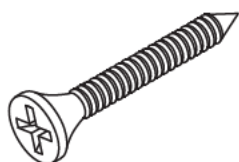
**E** x28+2(spare)

M3.5\*30

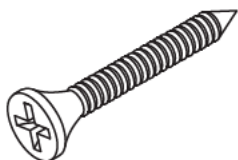
**F** x32+2(spare)

M3\*16

**EN** Do not confuse similar screws.  
**FR** Ne pas confondre des vis similaires.  
**ES** No confunda tornillos similares.  
**PT** Não confundir parafusos semelhantes.  
**DE** Verwechseln Sie ähnliche Schrauben nicht.  
**IT** Non confondere le viti simili.

**NOTE**



**C**x04

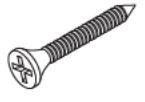

M3.5\*45

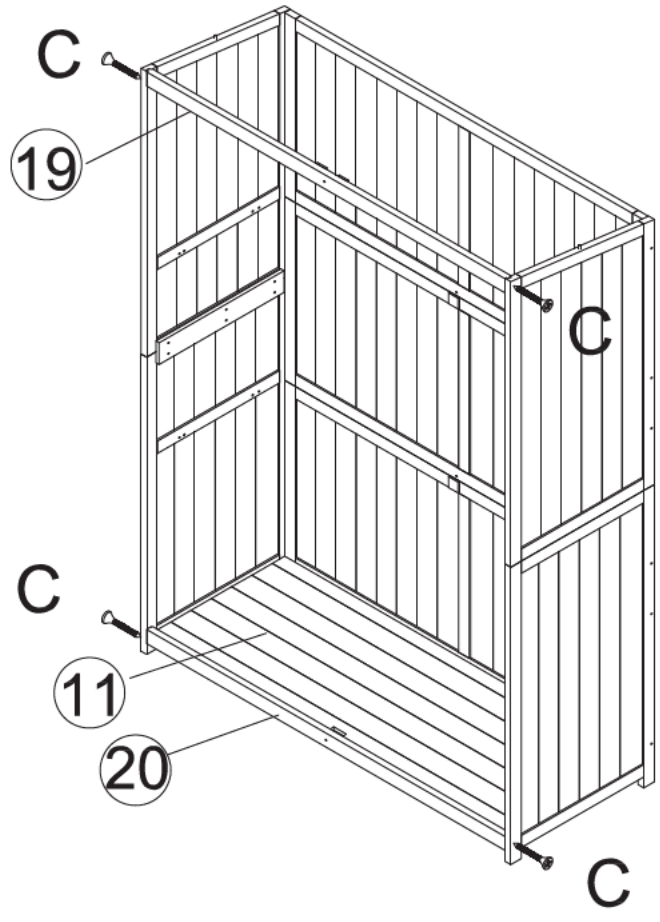

**C**x01



M3.5\*45

**D**x01

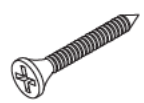

M3.5\*35

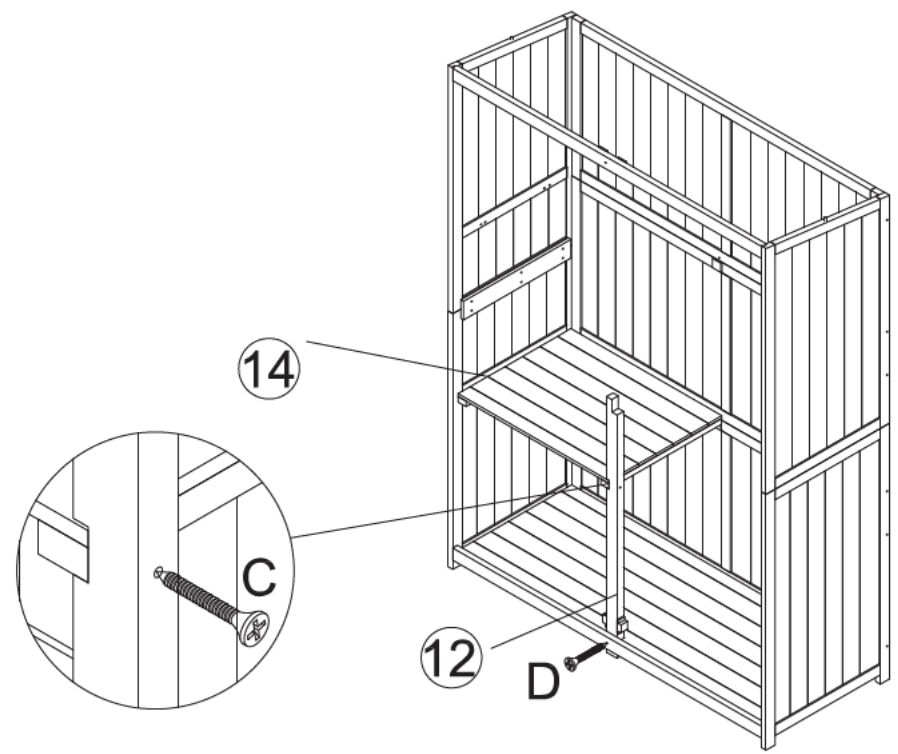

**C**x01



M3.5\*45

**D**x02



M3.5\*35

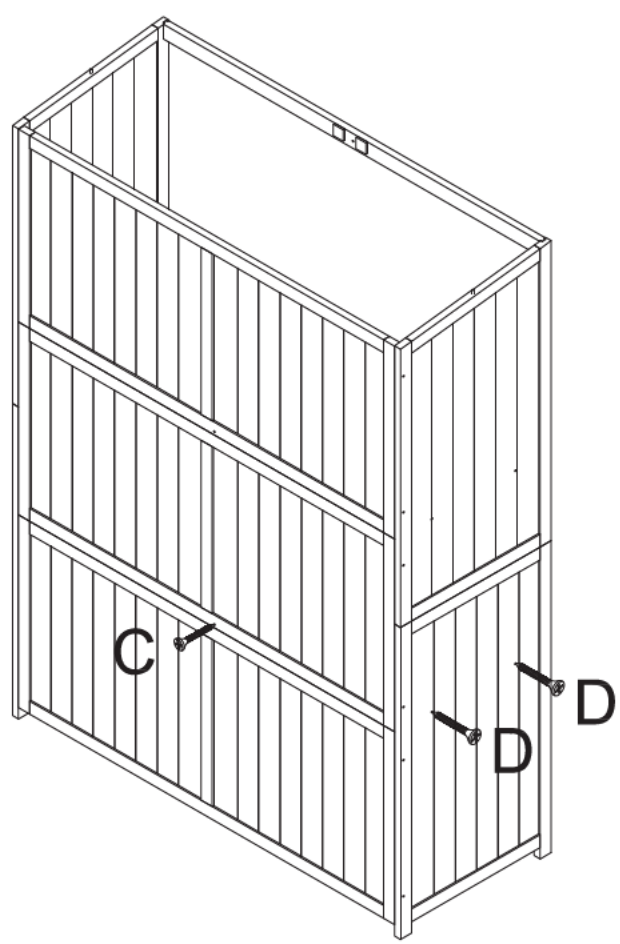

**C**x01

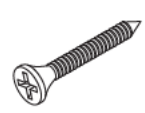

M3.5\*45

**D**x02

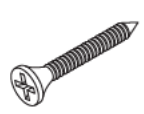

M3.5\*35

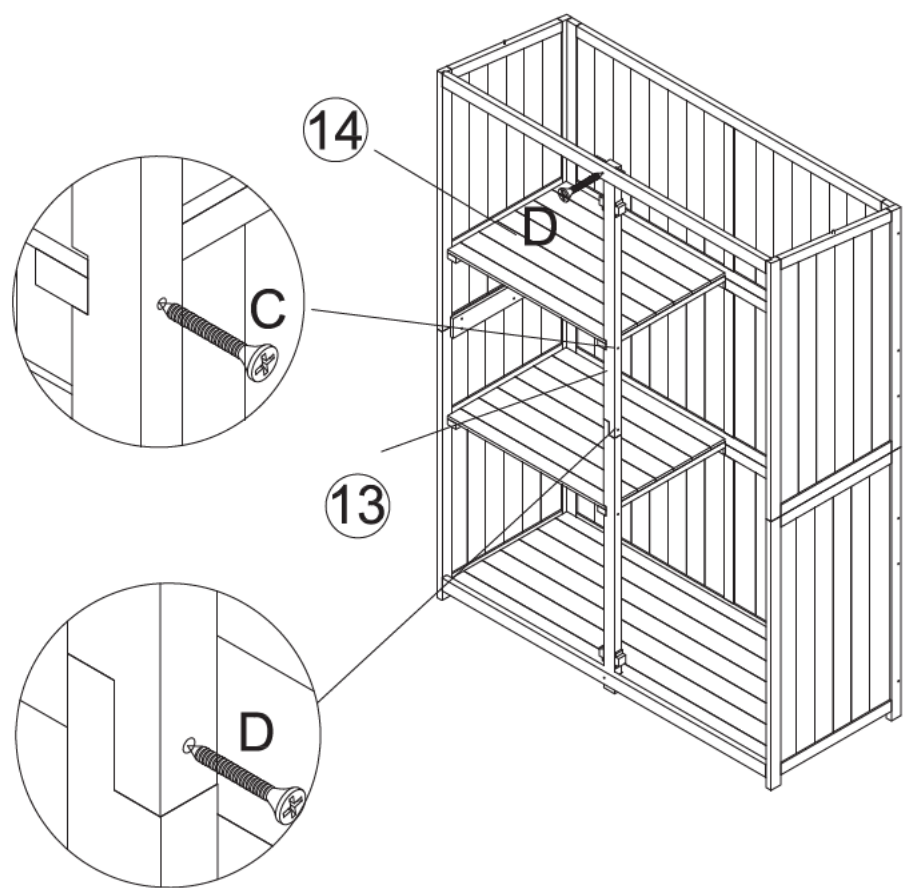

**C**x01



M3.5\*45

**D**x02



M3.5\*35

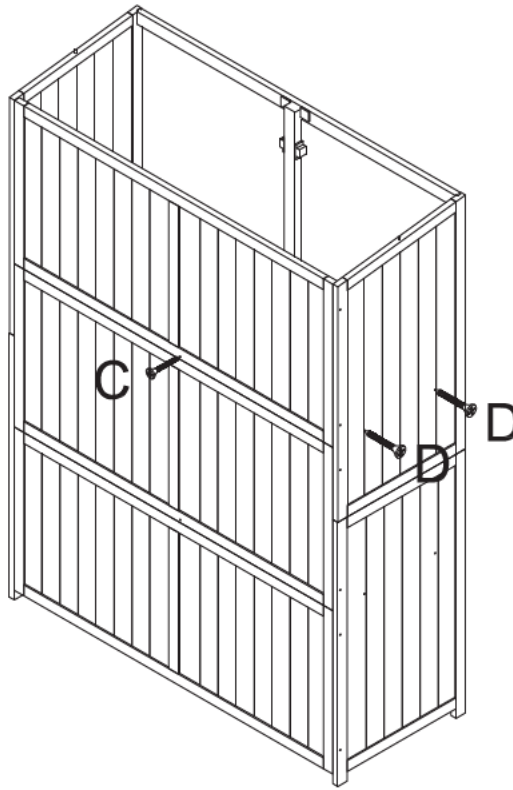

**A**x02



**D**x04



M3.5\*35

**E**x16



M3.5\*30

**F**x32

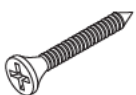

M3\*16

