

# ASSEMBLY INSTRUCTIONS

# INSTRUCTIONS DE MONTAGE

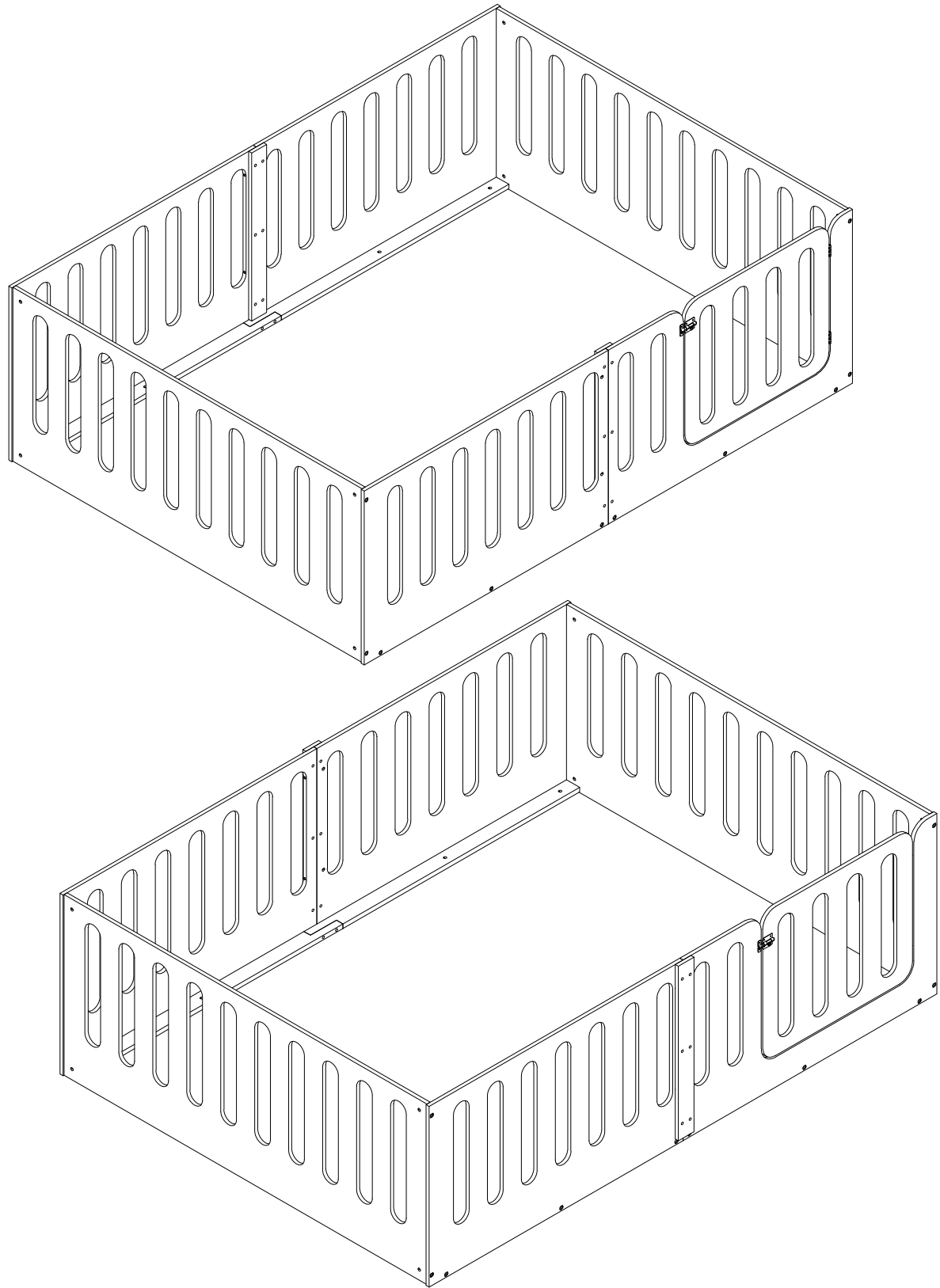

**RH00002**

# Detail View - Vue détaillée

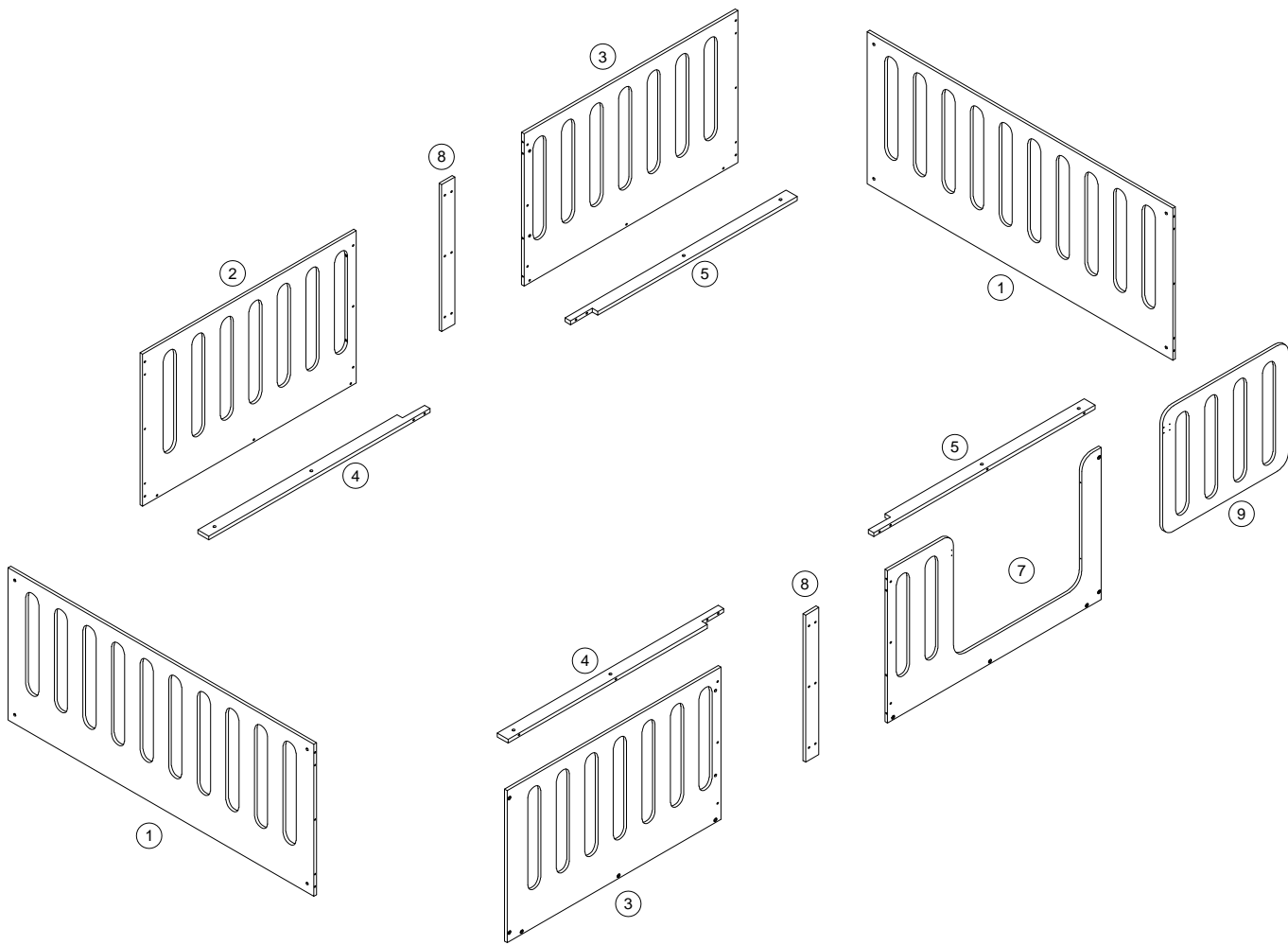

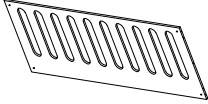
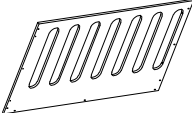
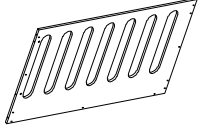
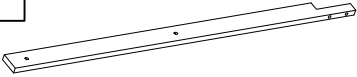
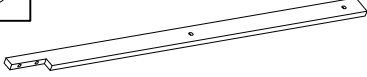
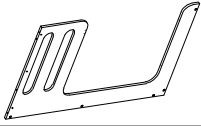
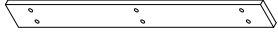
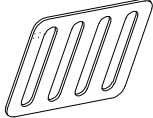

# Part Lists - Listes de pièces :

## RH00002

<p>①</p> 	<p>②</p> 	<p>③</p> 
<p>Side panel/Panneau latéral - 2pcs/pièces</p>	<p>Left backboard/Panneau arrière gauche - 1pc/pièce</p>	<p>Right board/Panneau de droite - 2pcs/pièces</p>
<p>④</p> 	<p>⑤</p> 	<p>⑦</p> 
<p>Clamp/Serrer - 2pcs/pièces</p>	<p>Clamp/Serrer - 2pcs/pièces</p>	<p>Front right board/Panneau avant droit - 1pc/pièce</p>
<p>⑧</p> 	<p>⑨</p> 	
<p>Standing riddle/Énigme debout - 2pcs/pièces</p>	<p>Door panel/Panneau de porte - 1pc/pièce</p>	

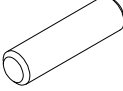
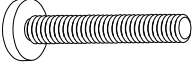
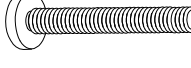
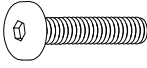
# Hardware Lists - Listes de matériel : RH00002

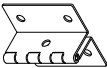
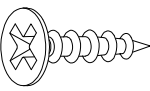
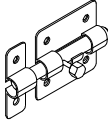
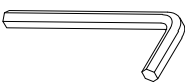
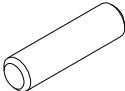
<p>(A)</p>  <p>Ø6*30mm</p>	<p>(B)</p>  <p>Ø1/4*50mm</p>	<p>(C)</p>  <p>Ø1/4*70mm</p>
<p>Wooden dowel/Cheville en bois - 12pcs/pièces</p>	<p>Horizontal/Horizontale - 20pcs/pièces</p>	<p>Horizontal/Horizontale - 4pcs/pièces</p>
<p>(D)</p>  <p>Ø1/4*20mm</p>	<p>(E)</p>  <p>Ø1/4*9.5*12mm</p>	<p>(F)</p>  <p>Ø1/4*15mm</p>
<p>Horizontal/Horizontale - 12pcs/pièces</p>	<p>Horizontal/Horizontale - 20pcs/pièces</p>	<p>Umbrella/Parapluie - 16pcs/pièces</p>
<p>(G)</p> 	<p>(H)</p>  <p>Ø3.5*12mm</p>	<p>(J) (J1)</p> 
<p>T-shaped bass/Basse en forme de T - 2pcs/pièces</p>	<p>Screws/Vis - 18pcs/pièces</p>	<p>Door lock/Serrure de porte - 1set/ensemble</p>
<p>(K)</p> 	<p>(L)</p>  <p>Ø8*30mm</p>	
<p>Allen Key/Cié Allen - 2pcs/pièces</p>	<p>Wooden dowel/Cheville en bois - 4pcs/pièces</p>	

## Step/Étape 1

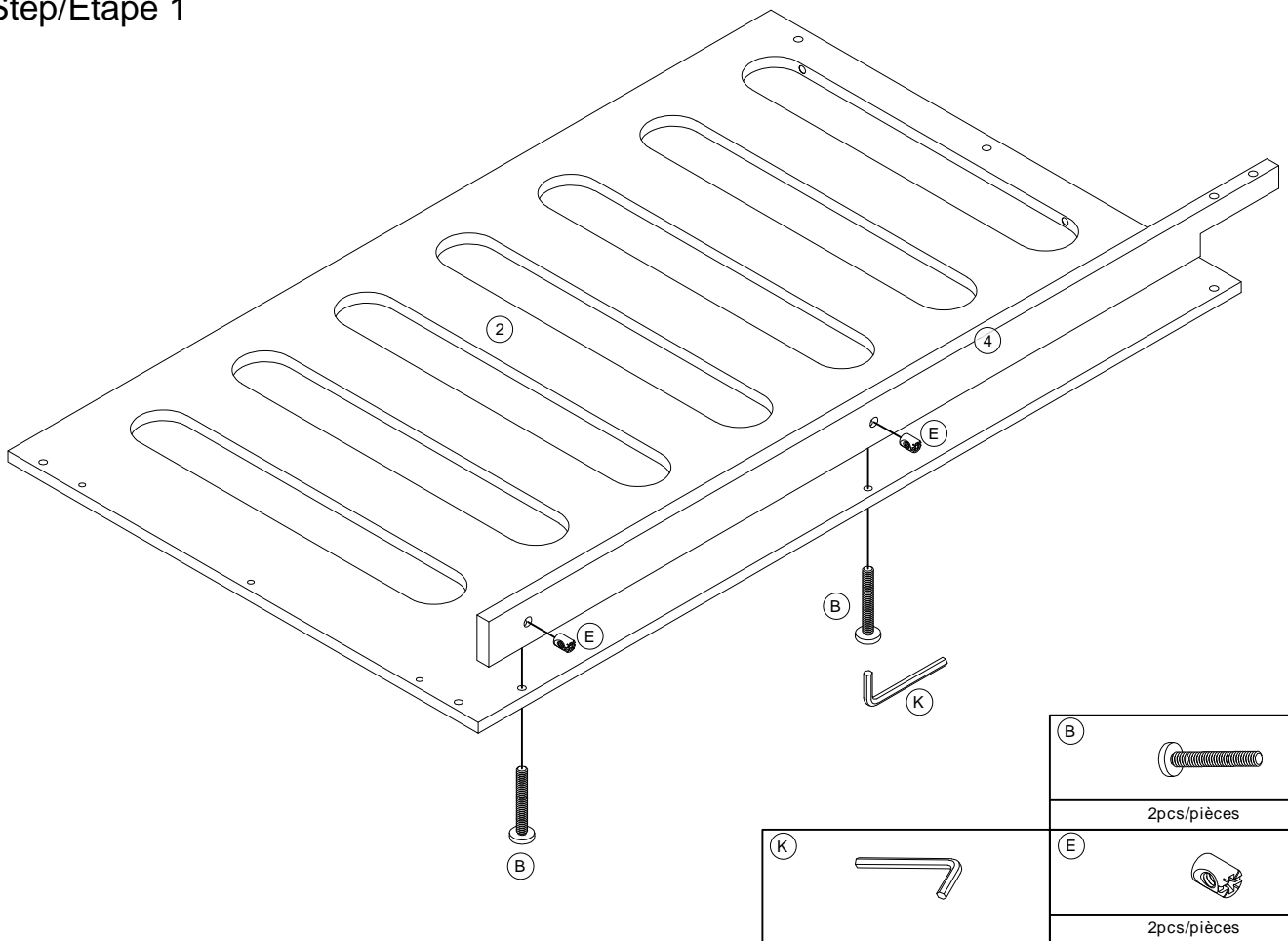

## Step/Étape 2

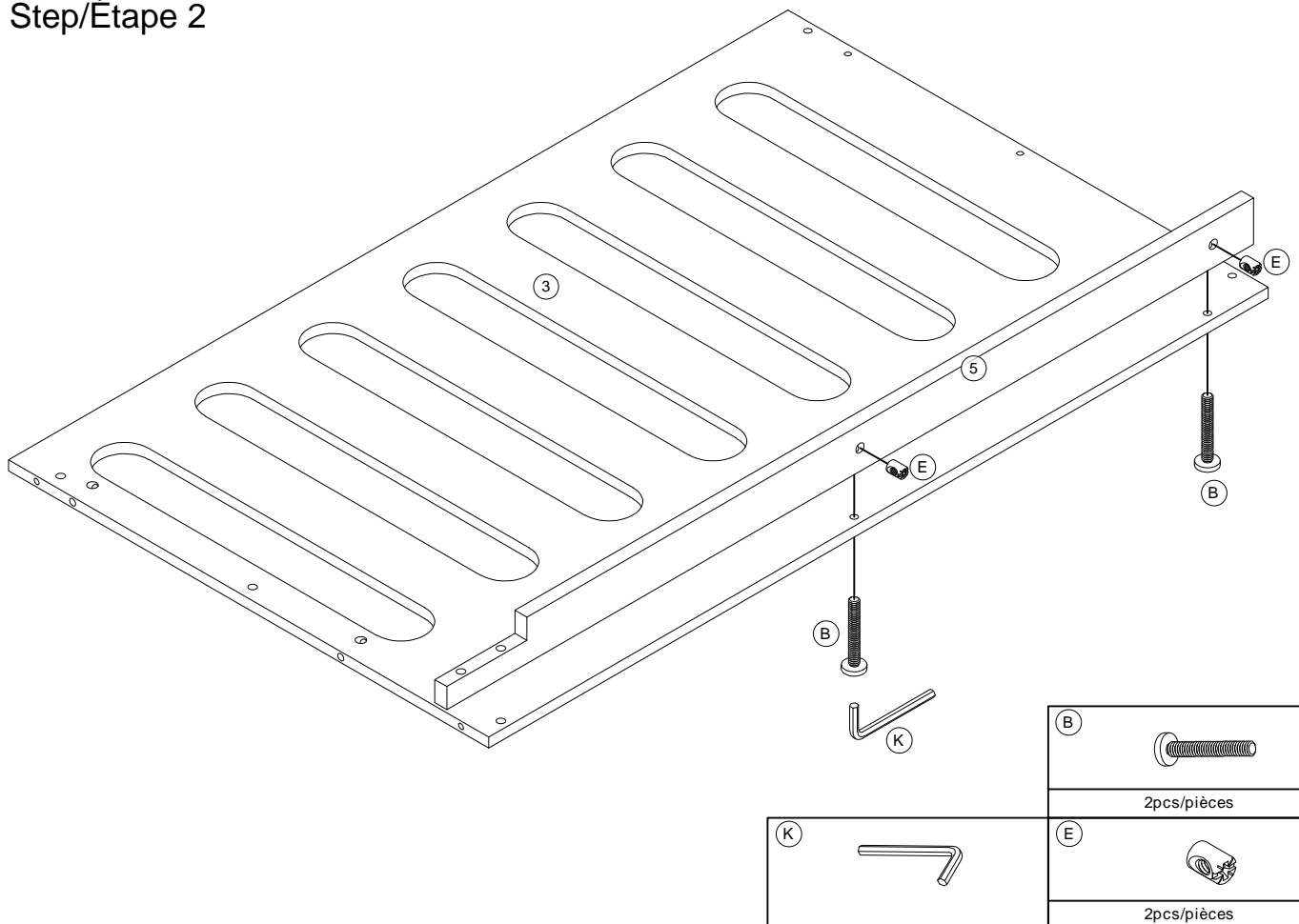

### Step/Étape 3

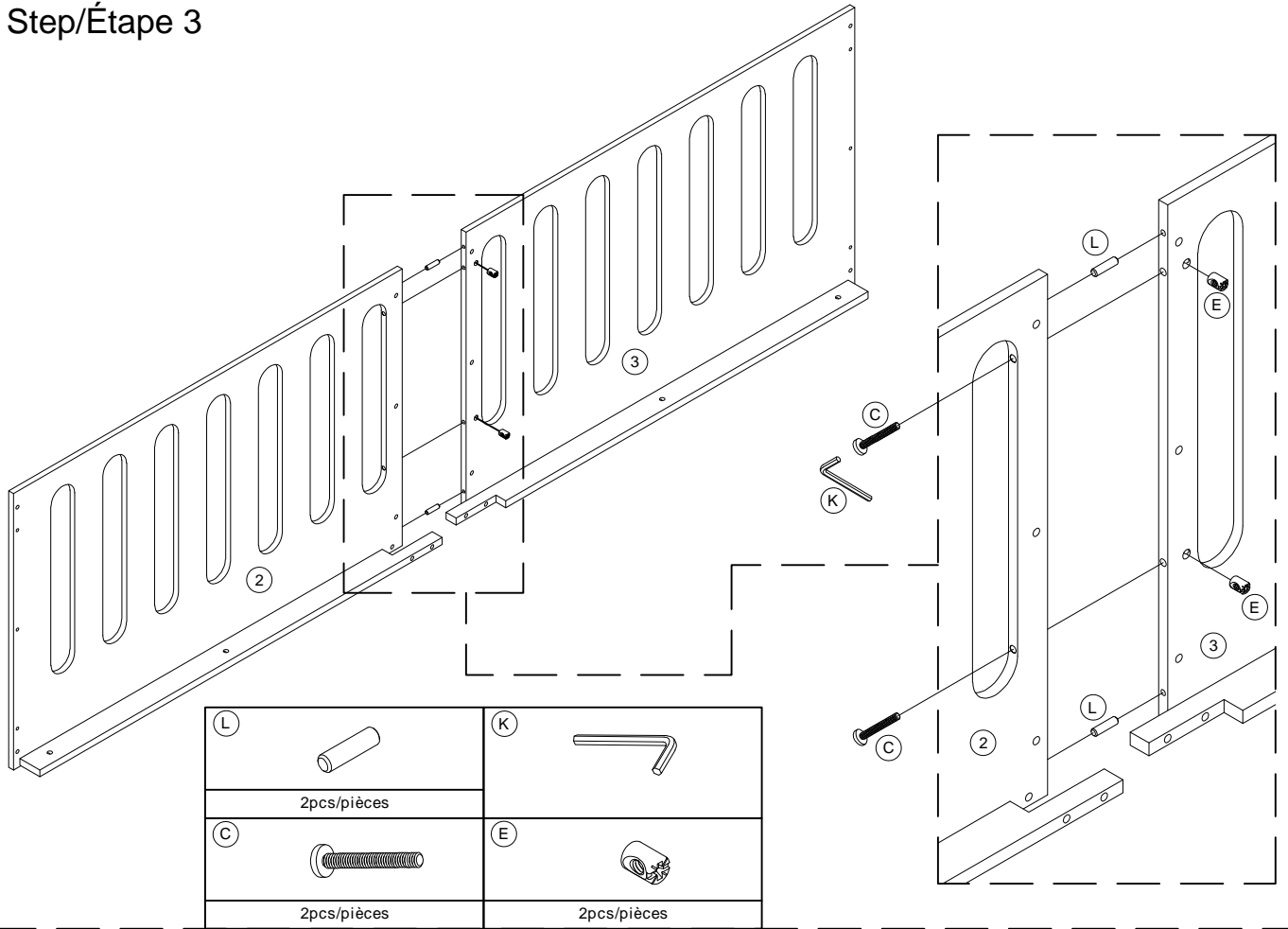

### Step/Étape 4

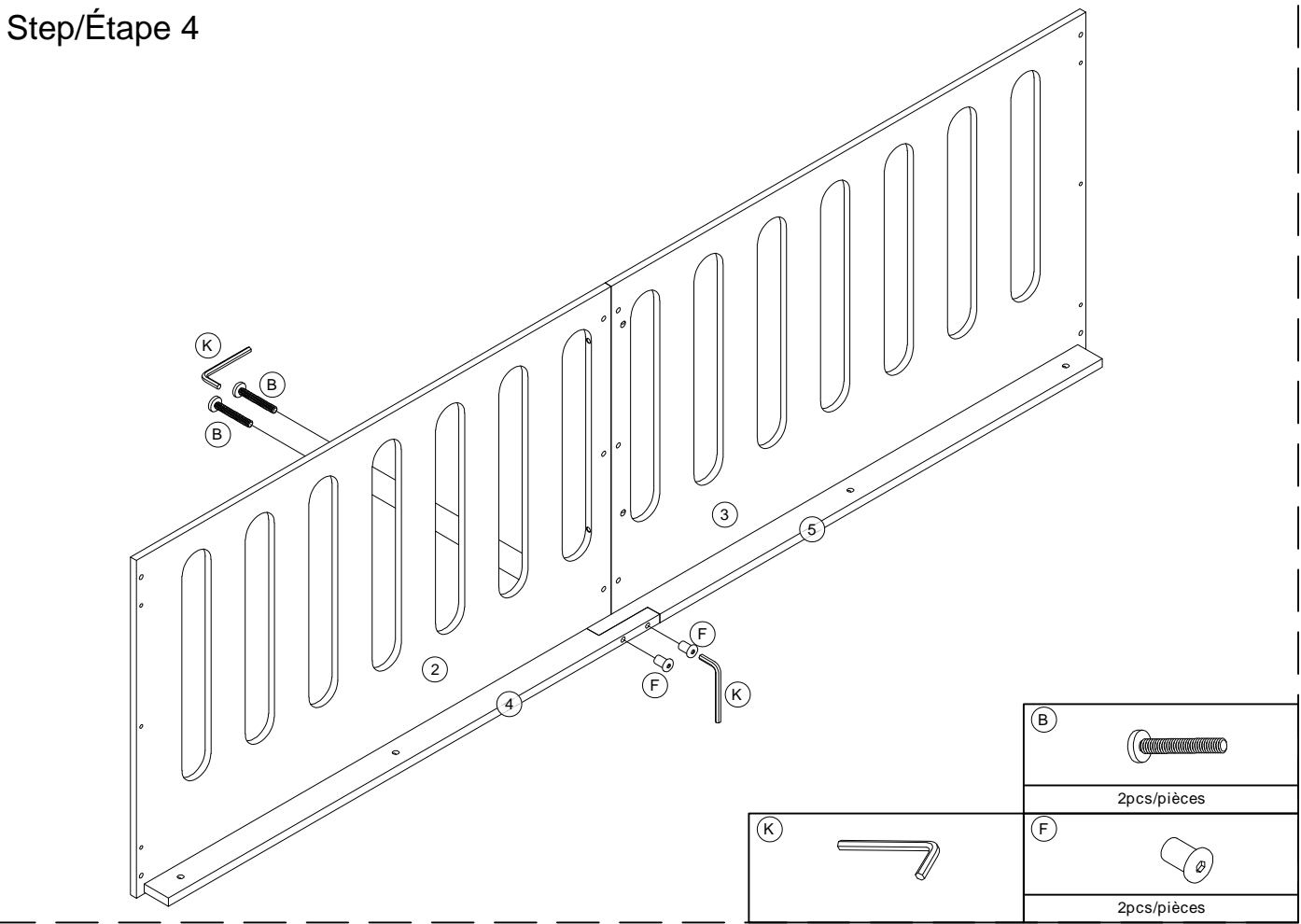

## Step/Étape 5

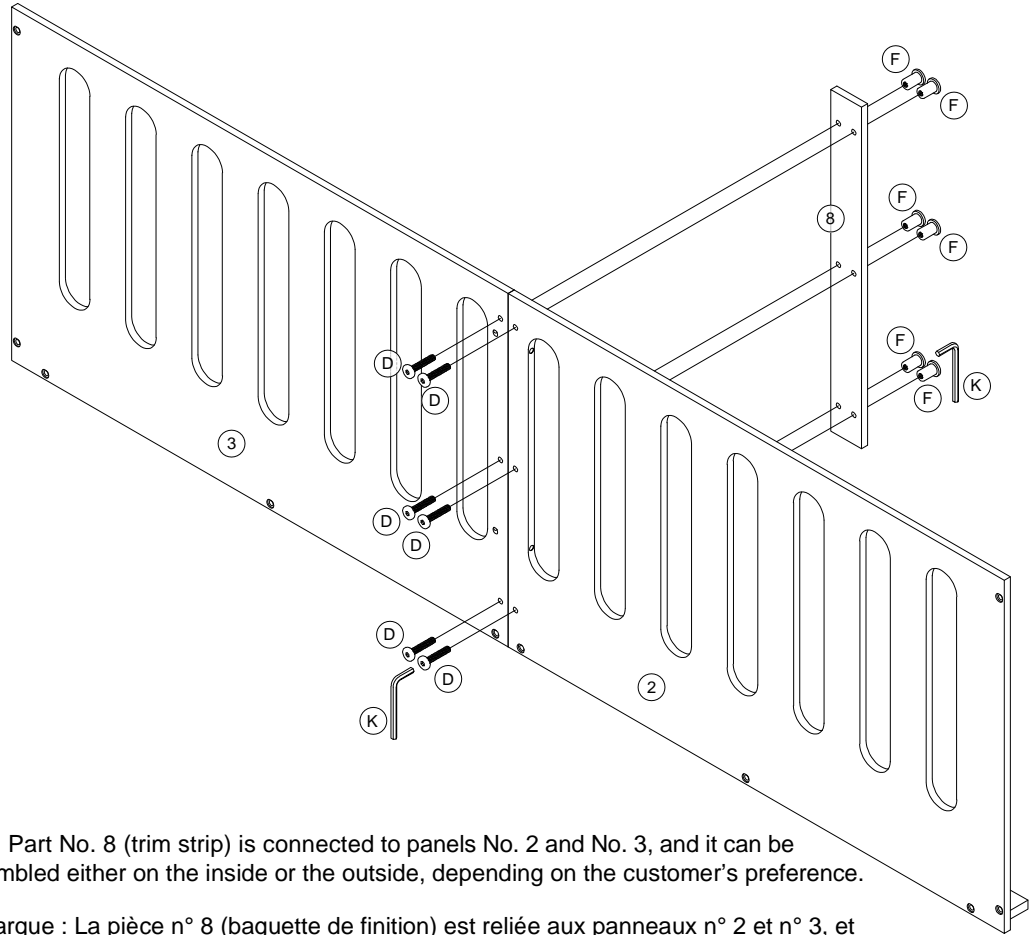

(F)	
6pcs/pièces	
(D)	
6pcs/pièces	
(K)	

Note: Part No. 8 (trim strip) is connected to panels No. 2 and No. 3, and it can be assembled either on the inside or the outside, depending on the customer's preference.

Remarque : La pièce n° 8 (baguette de finition) est reliée aux panneaux n° 2 et n° 3, et peut être assemblée soit à l'intérieur, soit à l'extérieur, selon la préférence du client.

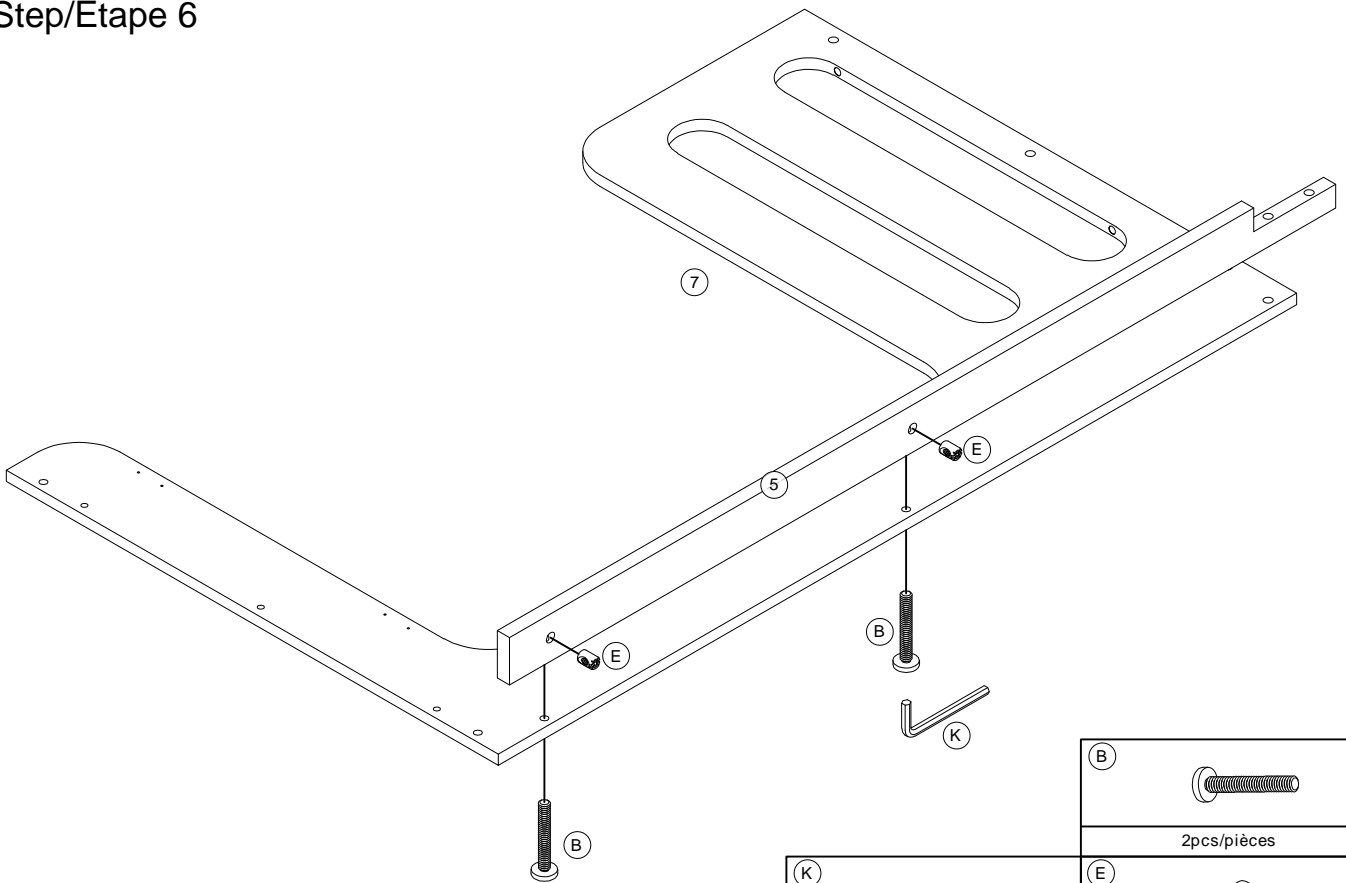

## Step/Étape 6



(B)	
2pcs/pièces	
(E)	
2pcs/pièces	
(K)	

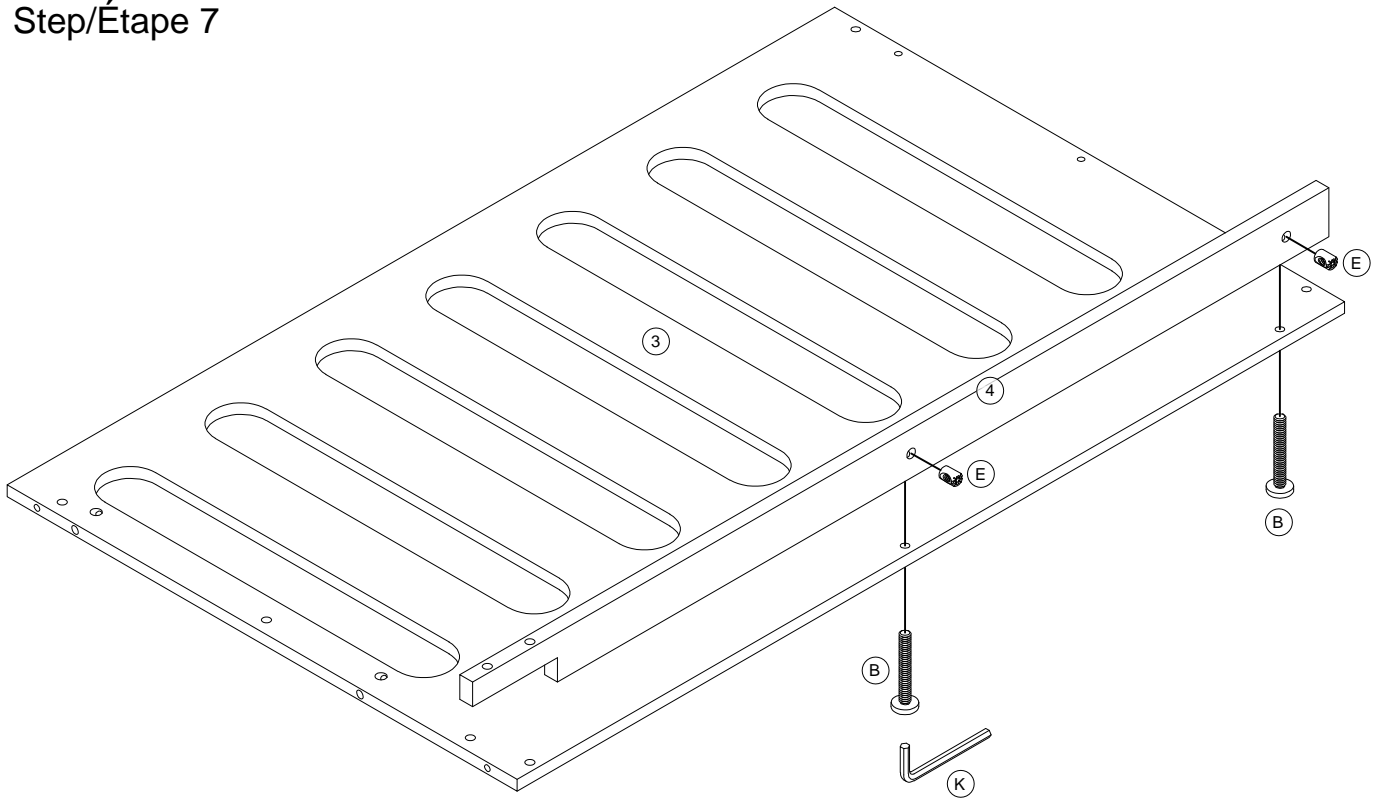



## Step/Étape 7

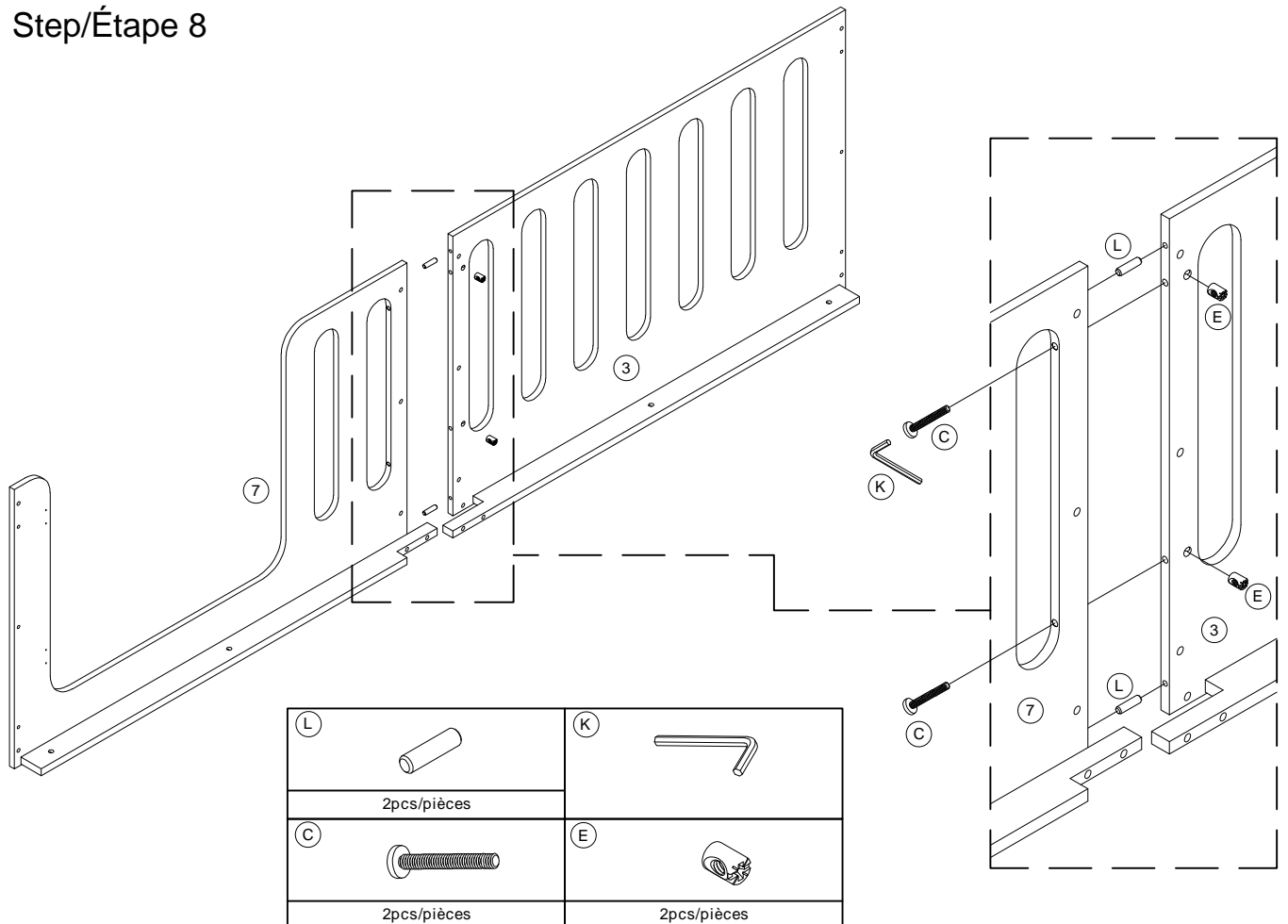

<p>(K)</p> 	<p>(E)</p>  <p>2pcs/pièces</p>	<p>(B)</p>  <p>2pcs/pièces</p>
--	---	---

## Step/Étape 8



<p>(L)</p>  <p>2pcs/pièces</p>	<p>(K)</p> 
<p>(C)</p>  <p>2pcs/pièces</p>	<p>(E)</p>  <p>2pcs/pièces</p>

## Step/Étape 9

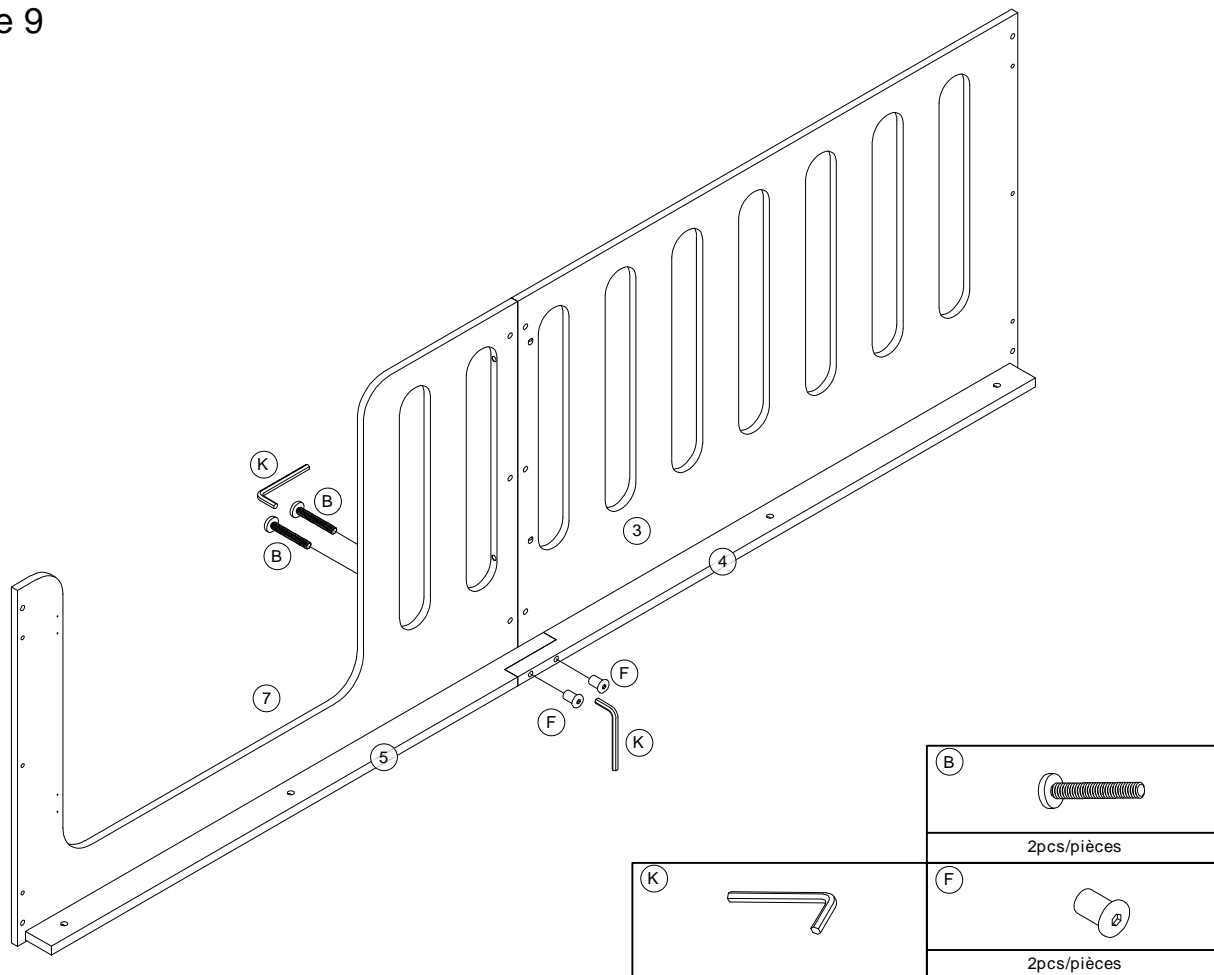

## Step/Étape 10

Note: Part No. 8 (trim strip) is connected to panels No. 3 and No. 7, and it can be assembled either on the inside or the outside, depending on the customer's preference.

Remarque : La pièce n° 8 (baguette de finition) est reliée aux panneaux n° 3 et n° 7, et peut être assemblée soit à l'intérieur, soit à l'extérieur, selon la préférence du client.

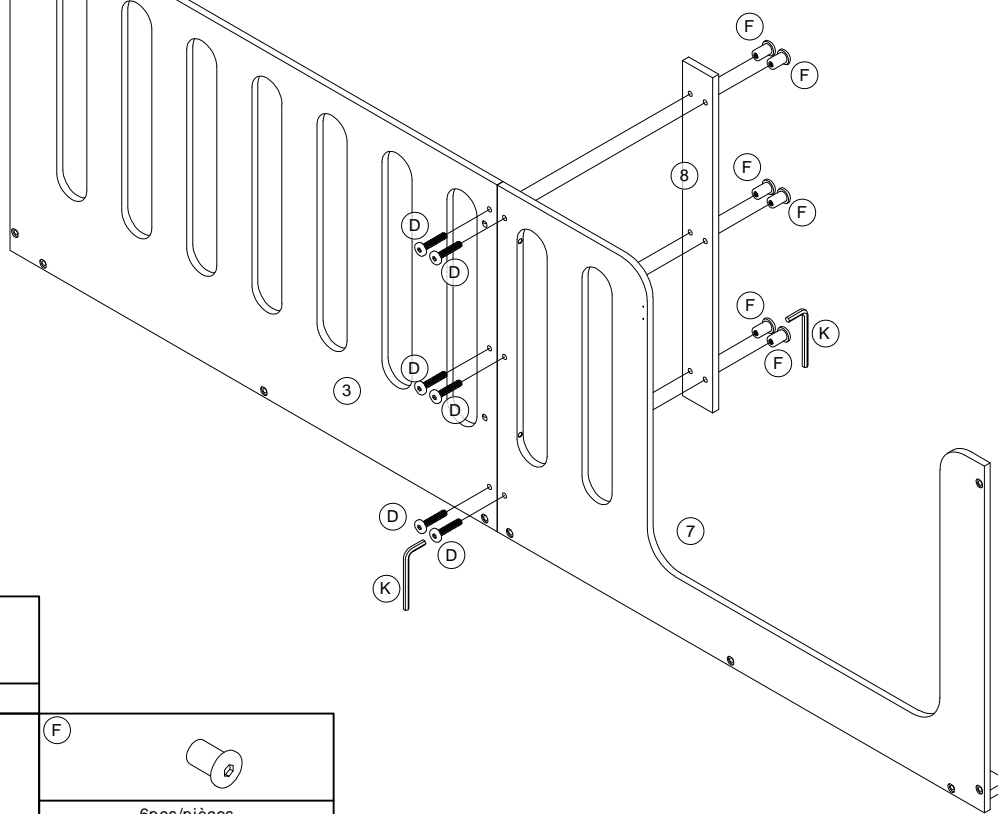

# Step/Étape 11

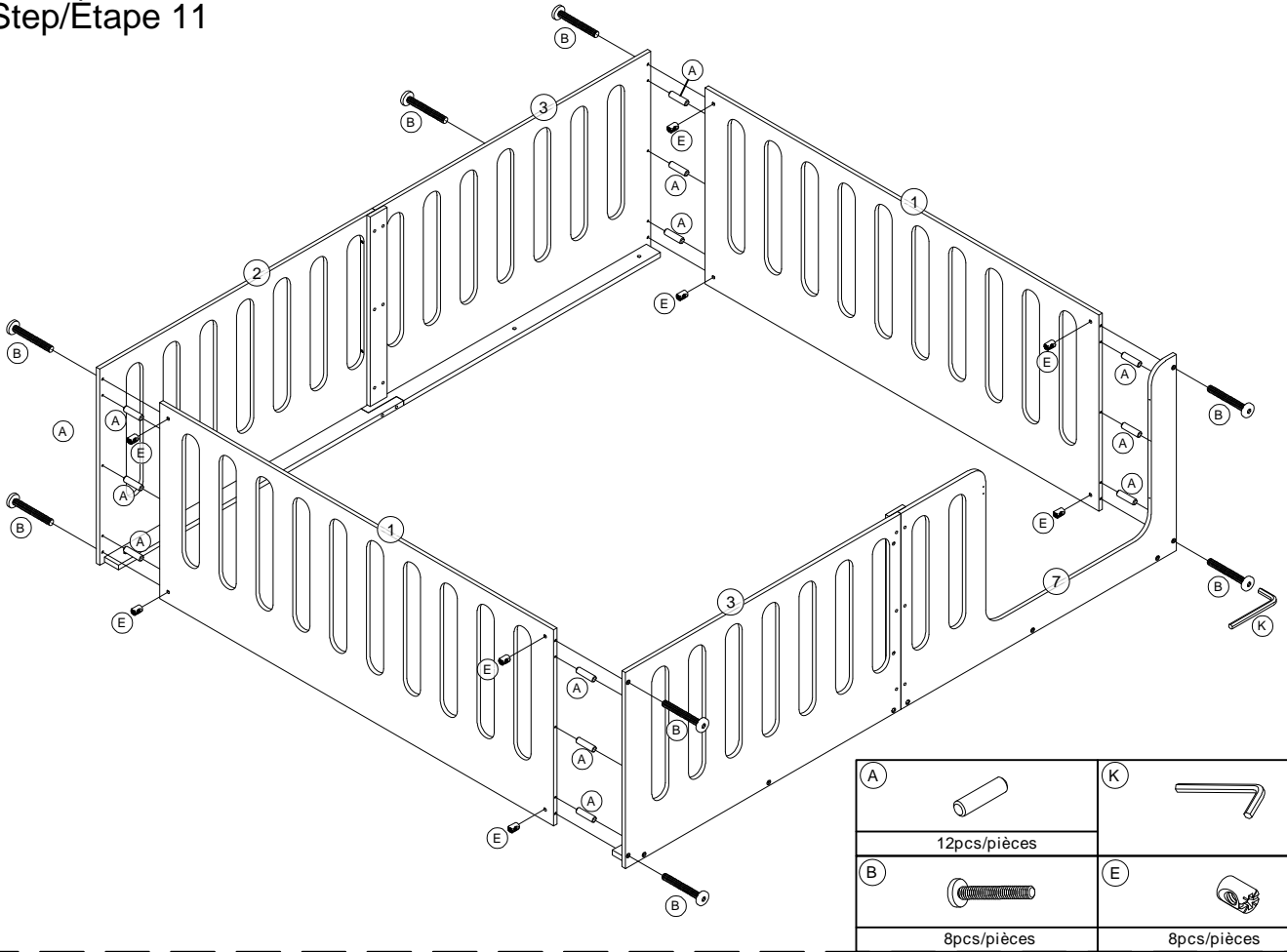

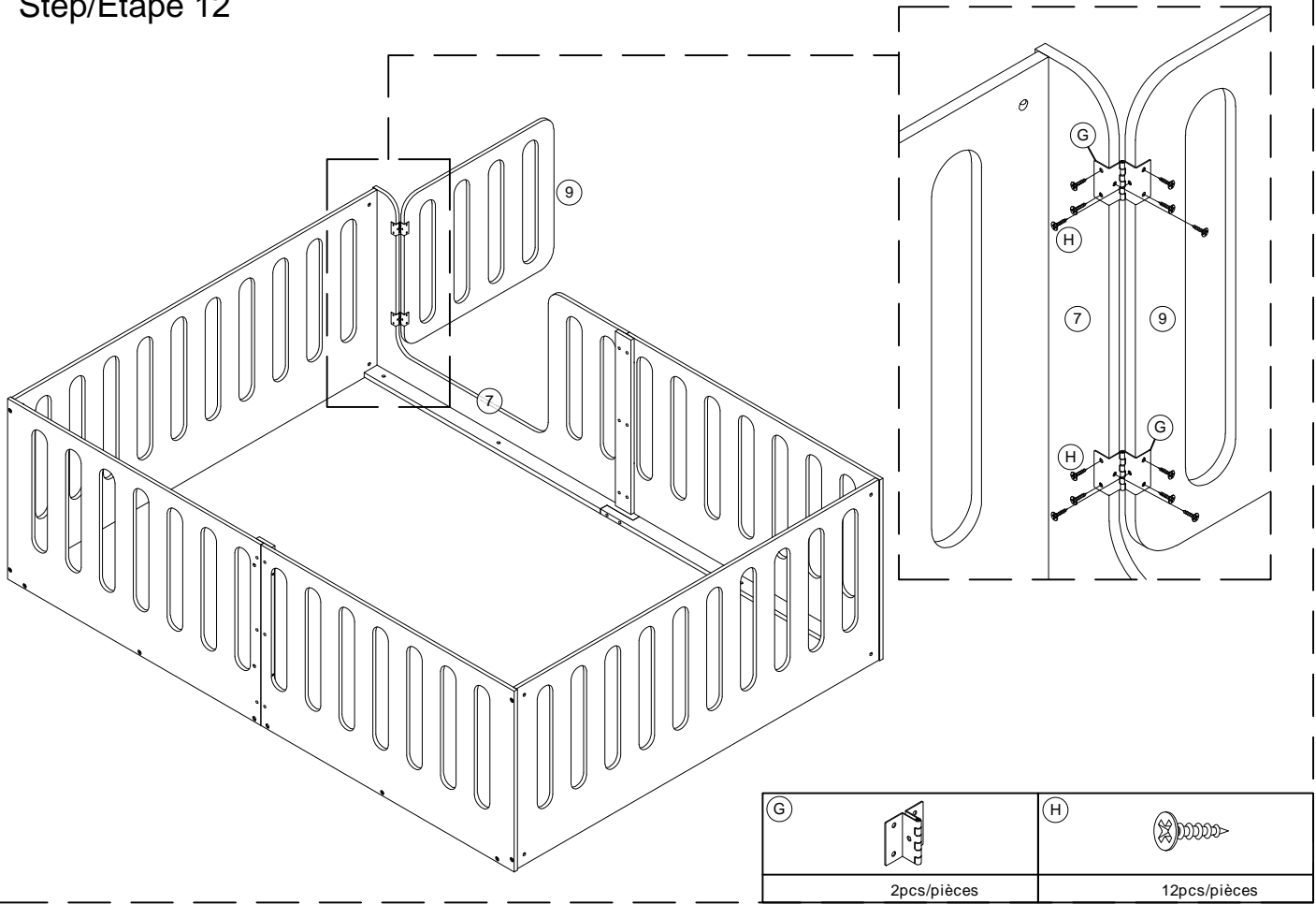

# Step/Étape 12

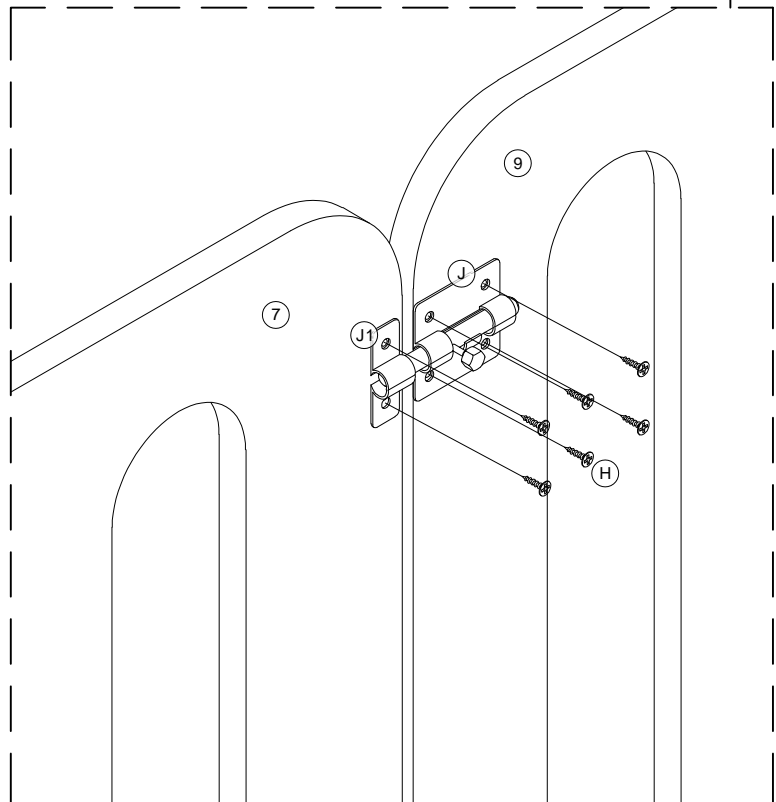
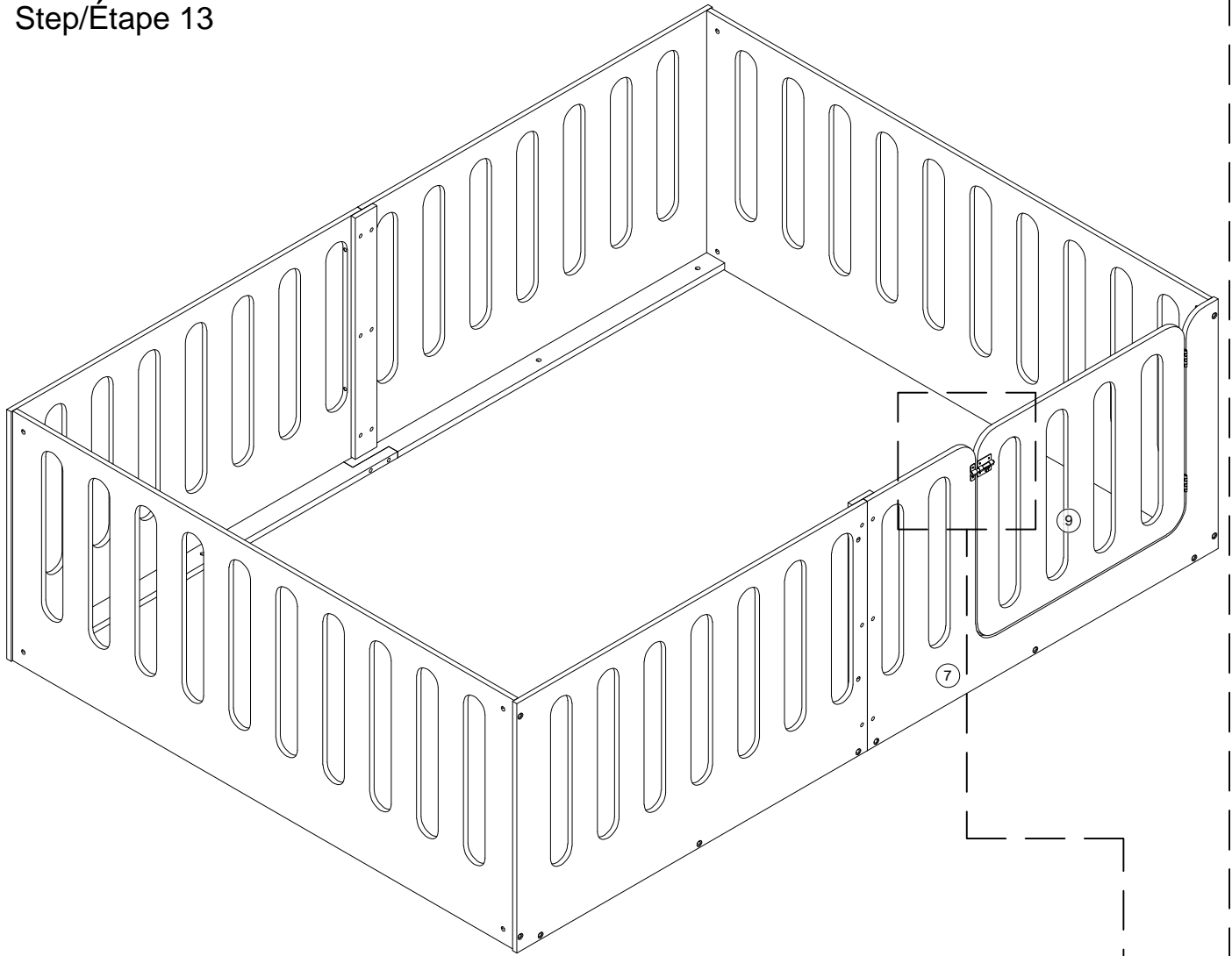

Step/Étape 13



(H)	
6pcs/pièces	
(J) (J1)	
1set/ensemble	

# COMPLETED - COMPLÉTÉ

