









# ASSEMBLY INSTRUCTION

NO.	PART	Q' TY
1	 TOP	1PC
2	 LEG	4PCS
3	 SHELF	1PC

NO.	HARDWARE	Q' TY
A	 $\phi 1/4" * 1-1/2"$	8PCS
B	 $\phi 1/4" * 5/8"$	8PCS
C	 $\phi 1/4" * 11mm$	16PCS
D	 $\phi 1/4" * 16mm$	16PCS
E	 $\phi 1/4"$	1PC
F	 $1" * 1" * 3/4" * 2mm$	4PCS

Step 1

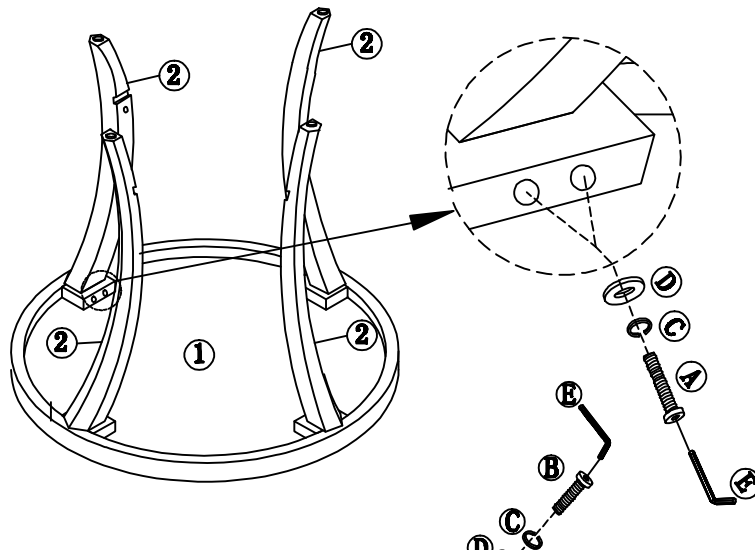

Step 2

