

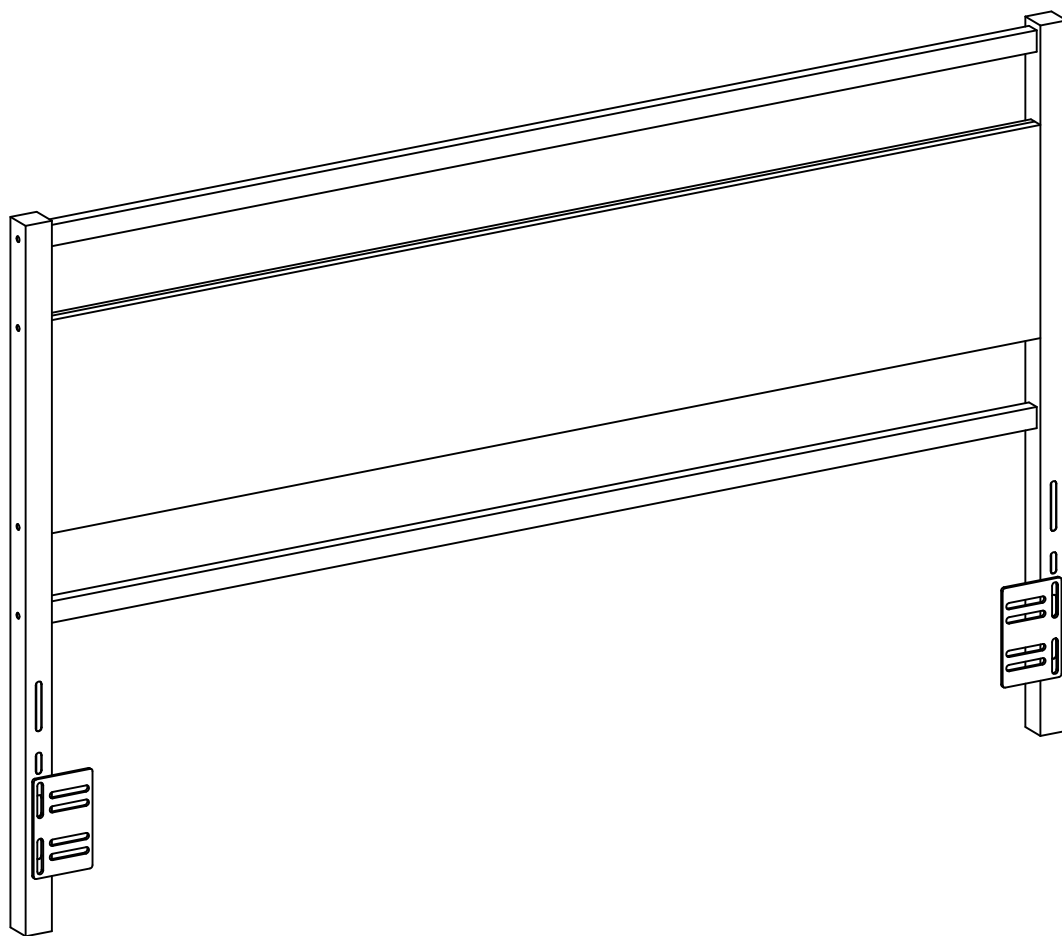

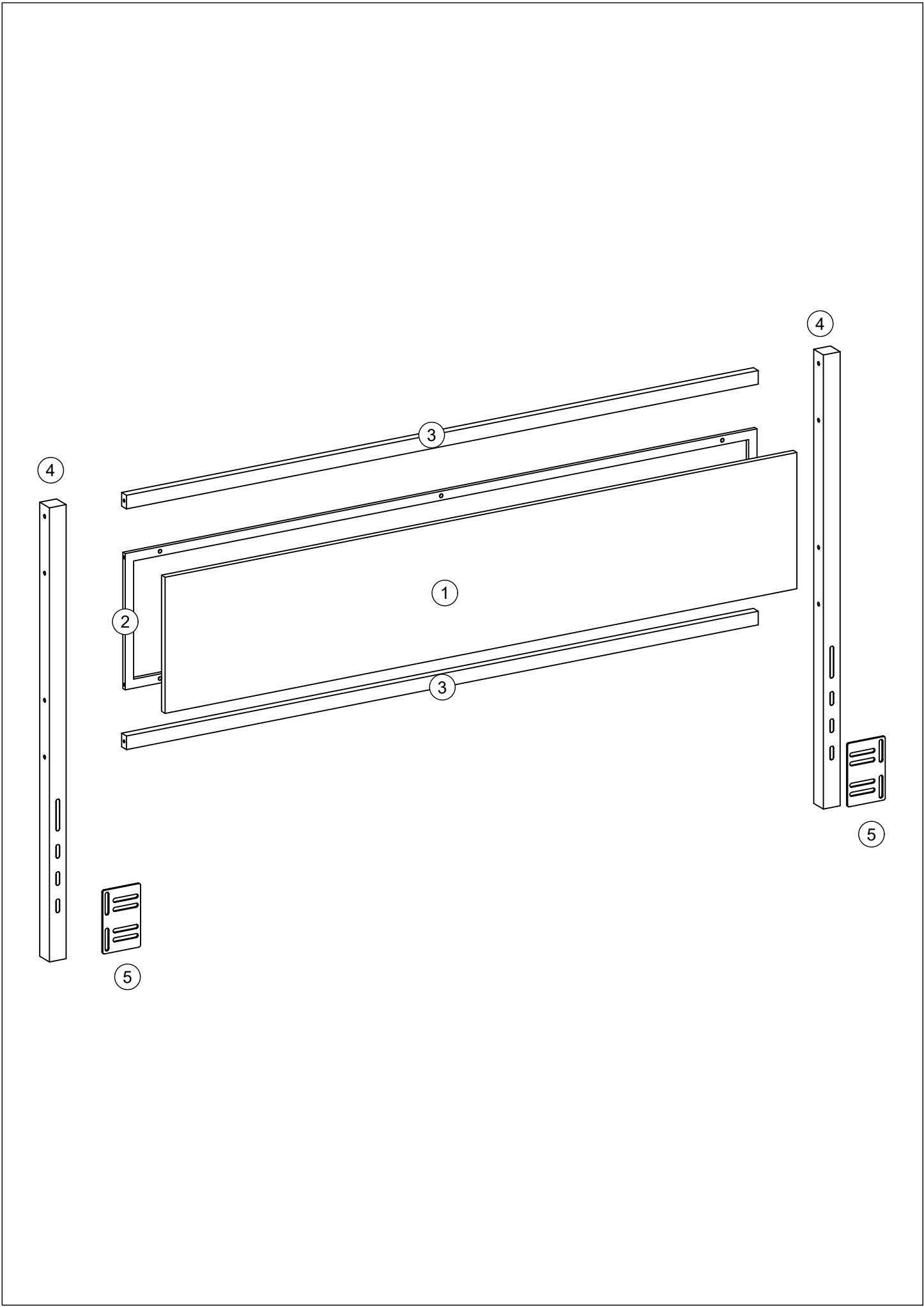

ASSEMBLY INSTRUCTION

CTB-03



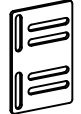

Parts List

<p>1</p>  <p>1pc</p>	<p>2</p>  <p>1pc</p>	<p>3</p>  <p>2pcs</p>	<p>4</p>  <p>2pcs</p>
<p>5</p>  <p>2pcs</p>			

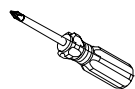



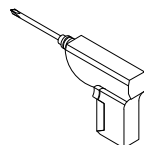



philips head screw driver
required of assembly
(Not include)

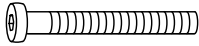
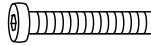

electric drill
(Not include)

Hardware List

<p>A</p>  <p>M6*60mm 8pcs</p>	<p>B</p>  <p>M6*50mm 4pcs</p>	<p>C</p>  <p>M6*20mm 6pcs</p>
<p>D</p>  <p>M6 8pcs</p>	<p>E</p>  <p>M6 4pcs</p>	<p>F</p>  <p>M6 1pc</p>
<p>G</p>  <p>M6 1pc</p>		

STEP 1:

C

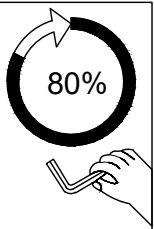
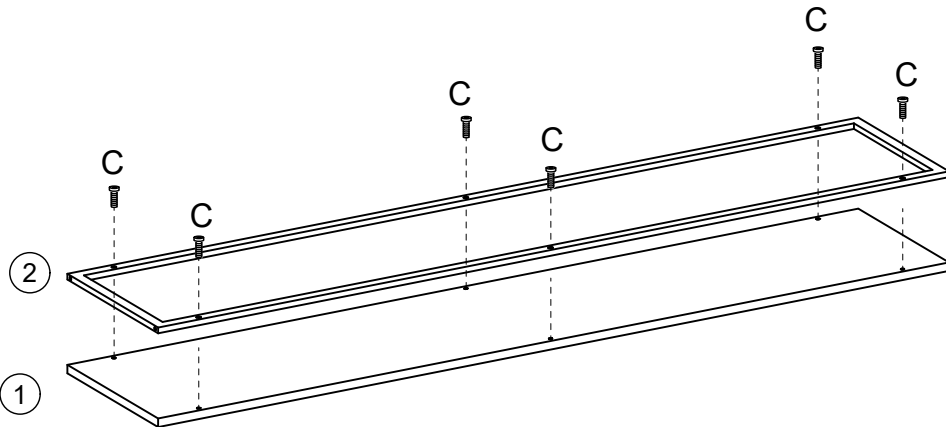
M6*20mm
6PCS





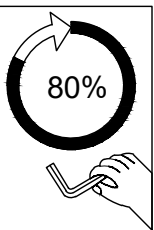
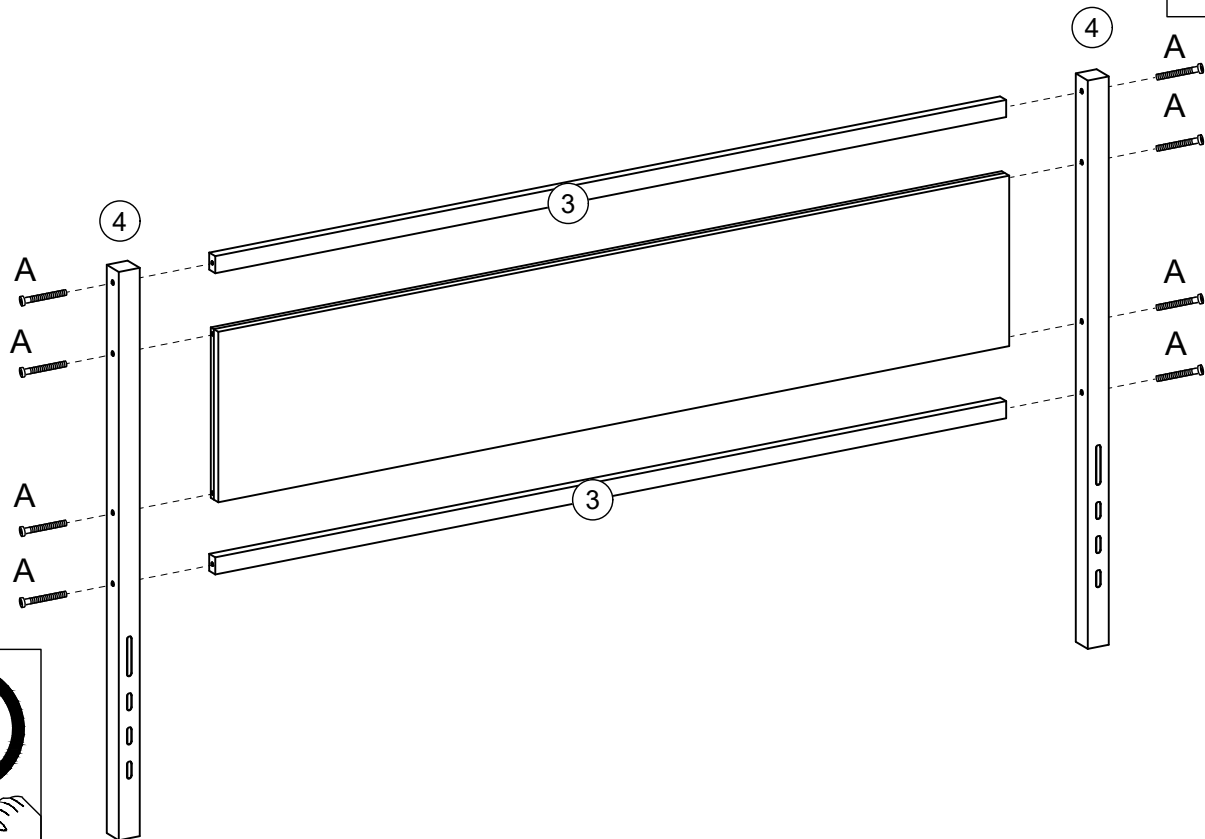

STEP 2:

A

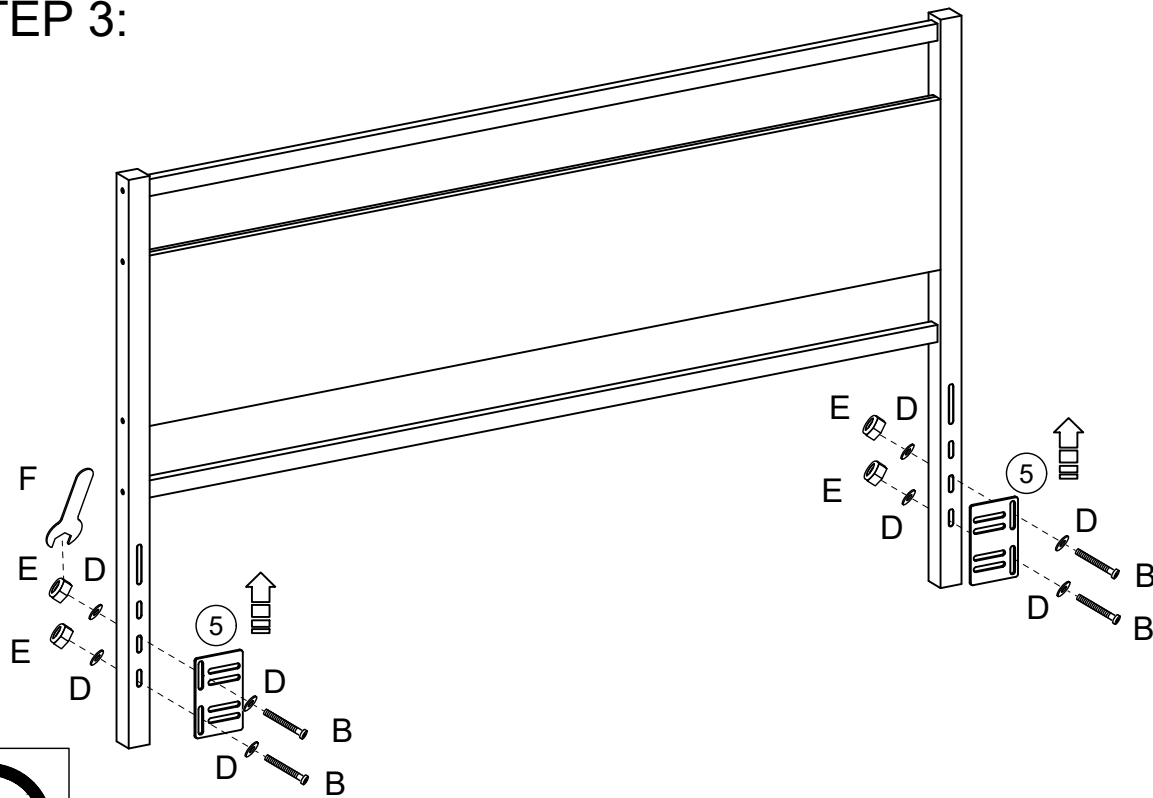
M6*60mm
8PCS



STEP 3:

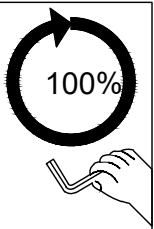

B
 M6*50mm 4PCS
D
 8PCS
E
 M6 4PCS
F
 M6 1PC



STEP 4:

