

ASSEMBLY INSTRUCTION

ITEM : N715P180449

DINING CHAIR

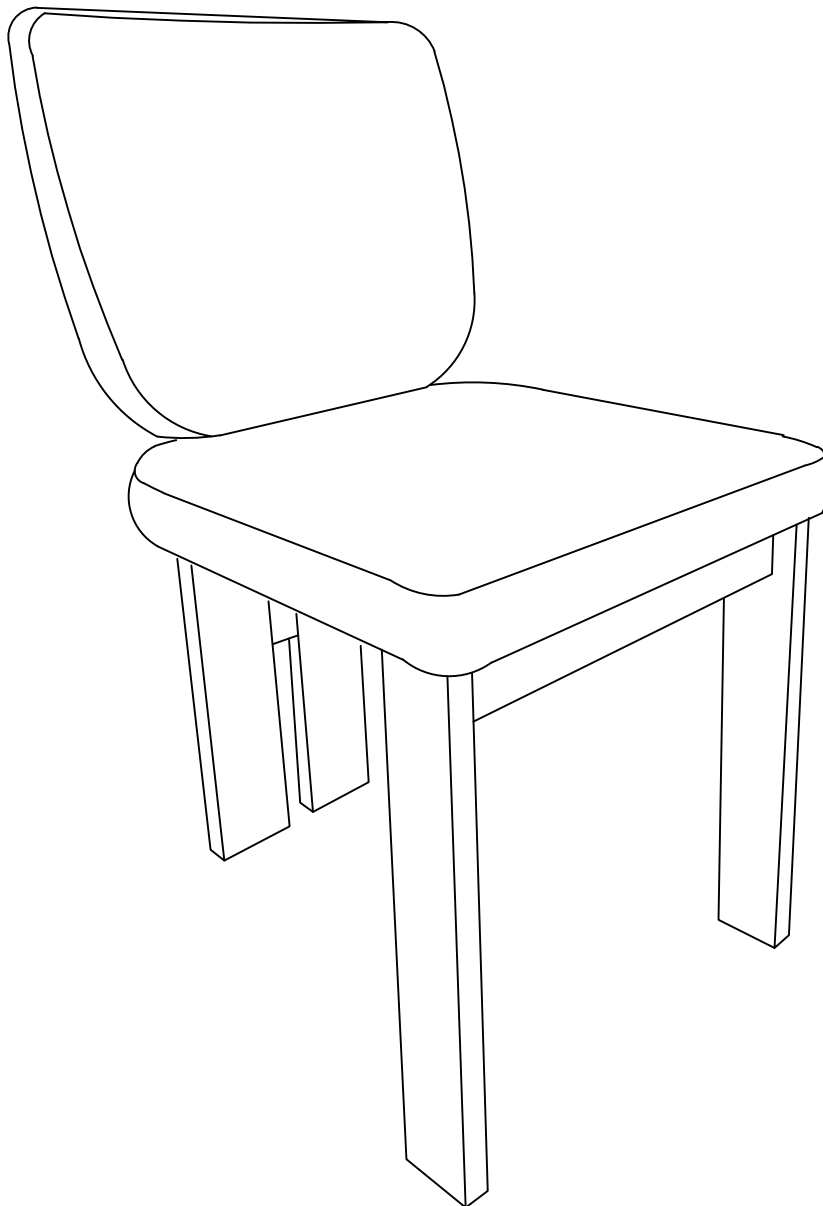

ASSEMBLY INSTRUCTION

ITEM : N715P180449

Important Note !

Please read these instructions fully before starting assembly:

1. Place all wooden parts on a clean and smooth surface such as a rug or carpet to avoid scratching the parts
2. Kindly follow the assembly instructions step by step.
3. Do not tighten all screws and bolts until the table is fully assembled.
4. Unscrew the protective plastique supports from the metal insert of the chair legs before assembly.
5. Parts of the assembly will be easier with 2 people.

Care and maintenance:

Only clean using a damp cloth and mild detergent, do no use bleach or abrasive cleaners.





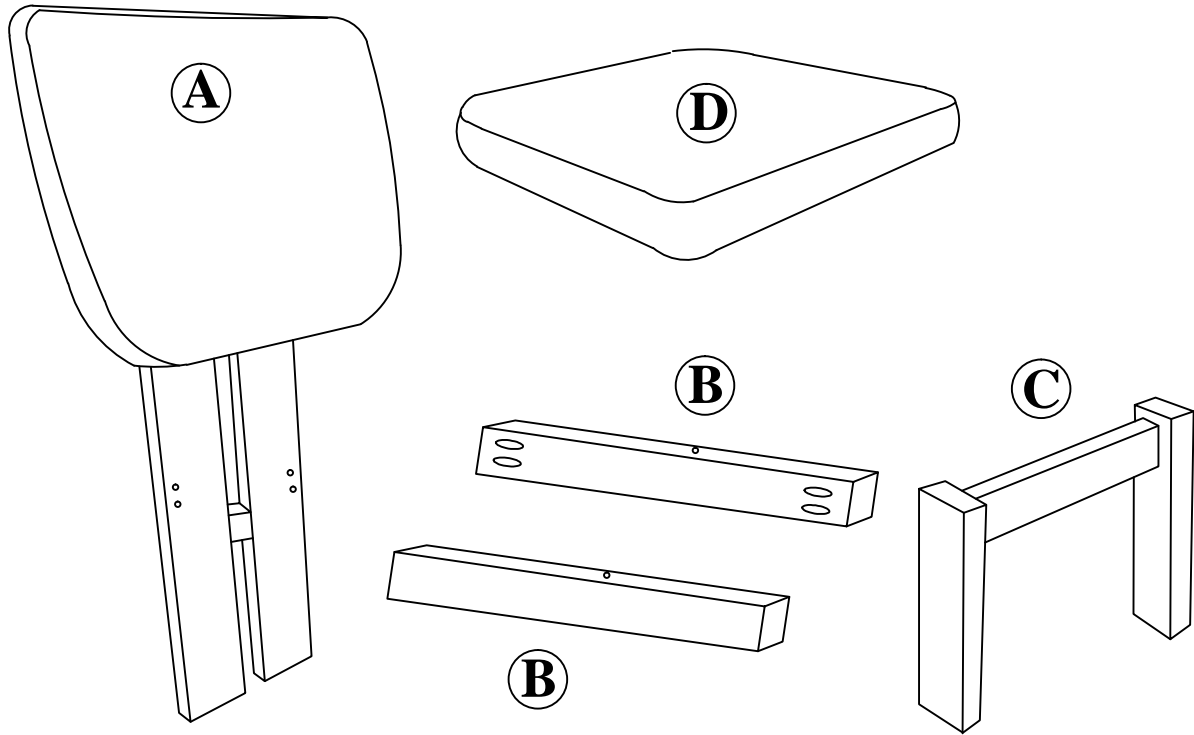

ASSEMBLY INSTRUCTION

ITEM : N715P180449

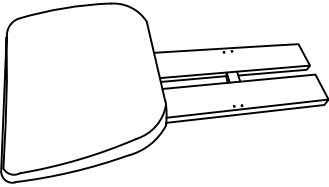
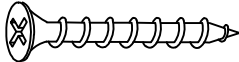

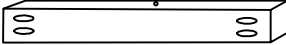
ASSEMBLY INSTRUCTION

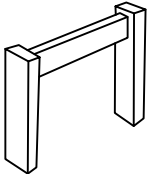
ITEM : N715P180449

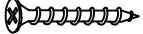
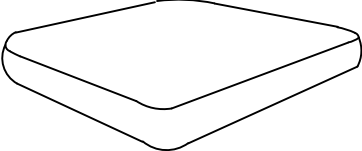

Part List For One	Hardware List For One
<p>A</p> 	<p>1</p>  <p>M4*32mm WOOD SCREW (4PCS)</p>
<p>BACK REST (1PC)</p>	<p>2</p>  <p>M6*50mm BOLT (8PCS)</p>
<p>B</p> 	<p>3</p>  <p>SPRING WASHER (8PCS)</p>
<p>SIDE PANEL (2PCS)</p>	<p>4</p>  <p>ALLEN KEY (1PC)</p>
<p>C</p> 	<p>5</p>  <p>L BRACKET (2PCS)</p>
<p>FRONT LEG (1PC)</p>	<p>6</p>  <p>M4*12mm WOOD SCREW (4PCS)</p>
<p>D</p> 	
<p>CUSHION SEAT (1PC)</p>	

ASSEMBLY INSTRUCTION

ITEM : N715P180449

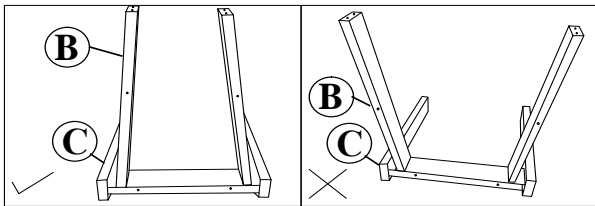
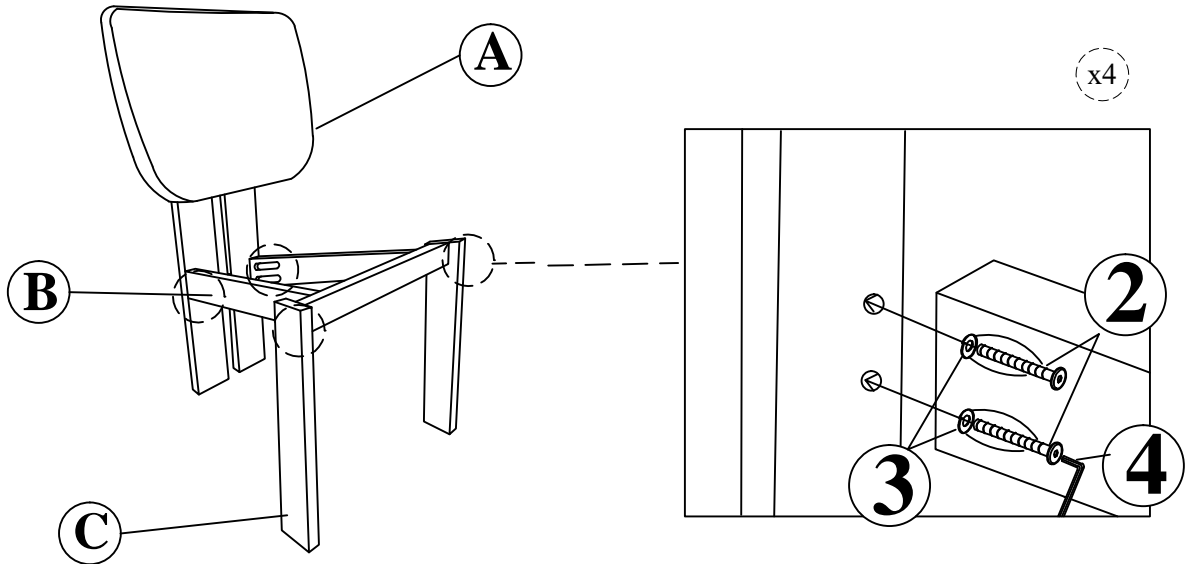

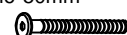
STEP 3

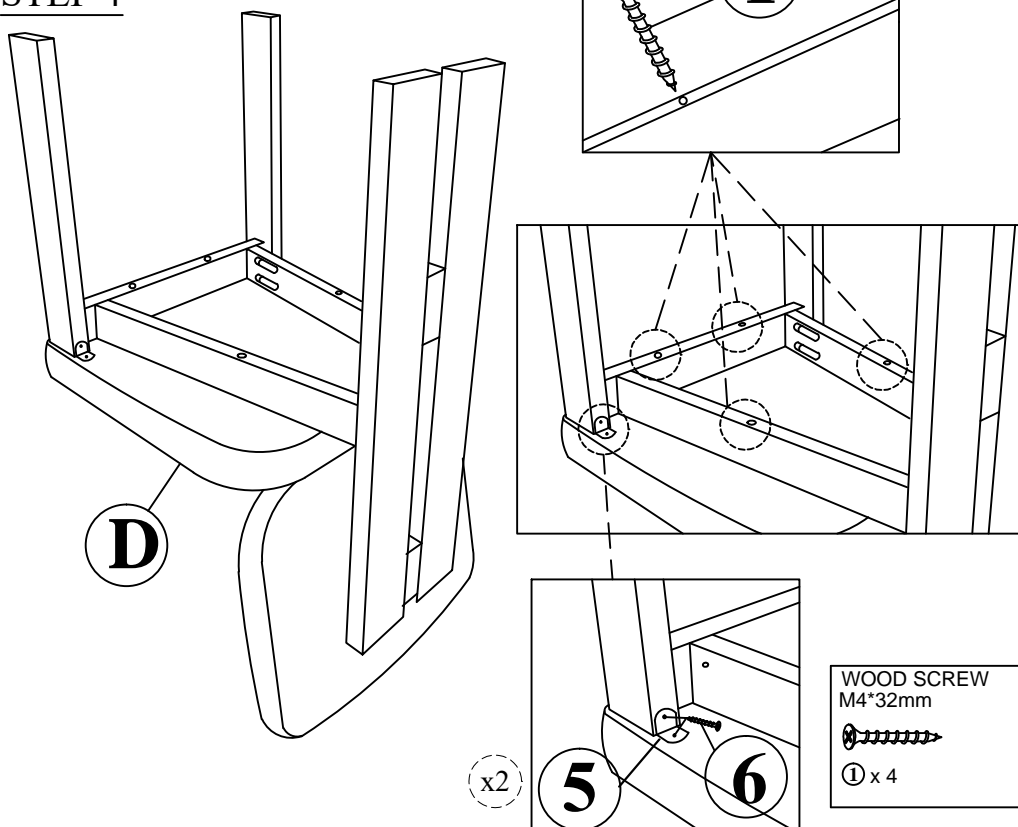

ALLEN KEY  ④ x 1	BOLT M6*50mm  ② x 8	SPRING WASHER  ③ x 8
--	---	---

STEP 4

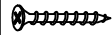

WOOD SCREW M4*32mm  ① x 4	L BRACKET  ⑤ x 2	WOOD SCREW M4*12mm  ⑥ x 4
--	---	---

ASSEMBLY INSTRUCTION

ITEM : N715P180449

COMPLETE

