

Owner Manual



CUSTOMER SERVICE

Assembly Instruction

- 1、 Check out our Youtube channel for step-by-step installation video.
- 2、 Please organize all pieces so that you can follow the instruction for smooth assembly.
- 3、 During the assembly, it is suggested that you make sure all the screws in the right position before finally tightening them.
- 4、 Note to self, don't be so excited and slow down and read the instructions step by step.
- 5、 Clear up enough space for the installation and remove any obstacles in the way.
- 6、 The product could be assembled by one person, but would recommend two.
- 7、 If any problems, please contact us via email for support and replacement and you will get reply within 24 hours.

1-Year Warranty

We offer 1-year warranty starting from the purchase date during normal use. But if any problems, please contact us via email for support and replacement and you will get reply within 24 hours.

More Efficient Response



To make us understand the exact problem and solve the problem more effectively, it would be better if you can send us the order ID and attach the pictures or videos illustrating the problems

Problems You May Encounter

Note	Problem	Solution
Dear Customer, Although we take great care to ensure our products are free from common market issues in material selection, production process and quality control, we understand that unexpected situations can still arise. If you encounter any difficulties or require assistance, please don't hesitate to reach out to us . Our dedicated team is always here to help and provides solutions within 24 hours.	If you have difficulty installing this product	Contact us via your order page or for a detailed installation video and personalized assistance to ensure successful installation and seamless usage of our product.
	Parts are missing, defective, or wrong parts in the package	Contact us via your order page, and we will respond within 24 hours. Alternatively, you could also contact us through our after-sales
	Board surface is broken, scratched, or lacks some screw holes	Contact us via your order page, and we will respond within 24 hours.
	The steel frame is bent, broken, painted, rusted, or damaged	If possible, you can take some photos of the bent part first, and then try to restore the iron frame to its original shape to make it work, then send us the picture and problems, and we will offer you a satisfactory answer.

TURN THE PAGE FOR ASSEMBLY MANUAL →

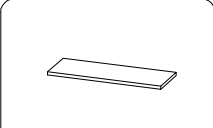
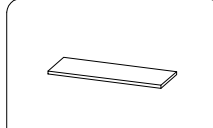
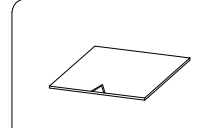
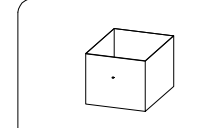
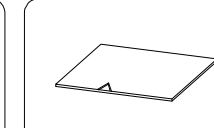
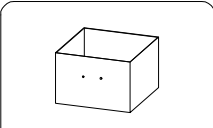
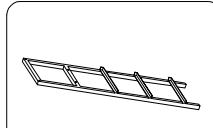
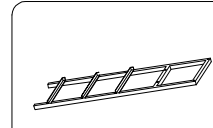
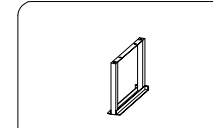
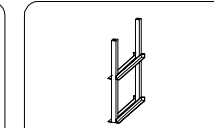
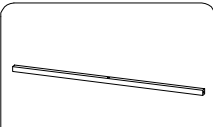
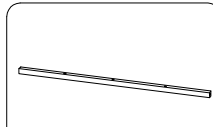
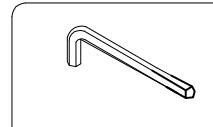
Assembly Instructions

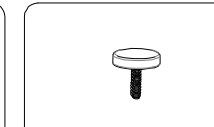
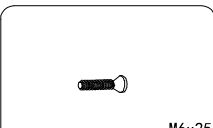
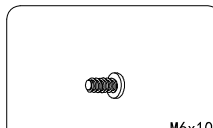
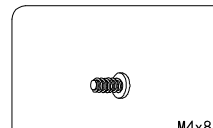
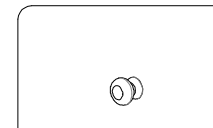
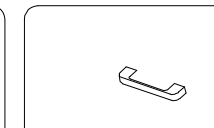
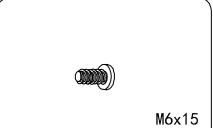
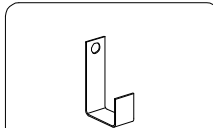
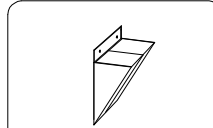
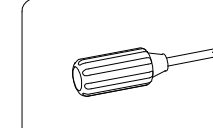
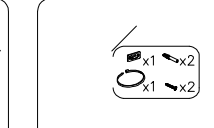
				
① x1	② x1	③ x3	④ x3	⑤ x4
				
⑥ x4	A x1	B x1	C x2	D x1
				
E x4	F x2	G x1	H x4	I x4
				
M6x25 J x26+2	M6x10 K x8	M4x8 L x11	M x3	N x4
				
M6x15 O x2	P x2	Q x1	R x1	S x2

STEP 1;

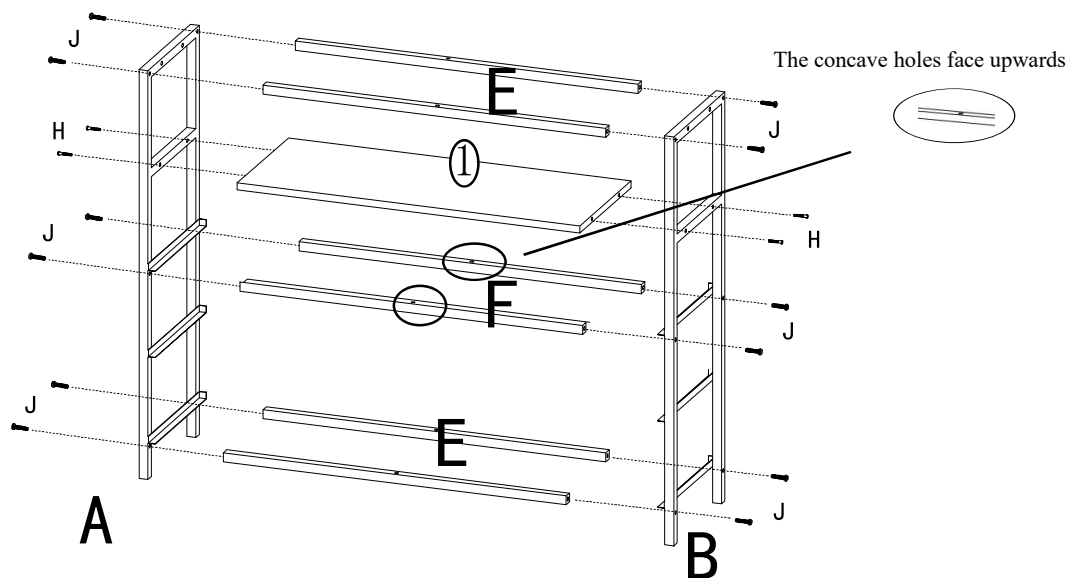

STEP 2:

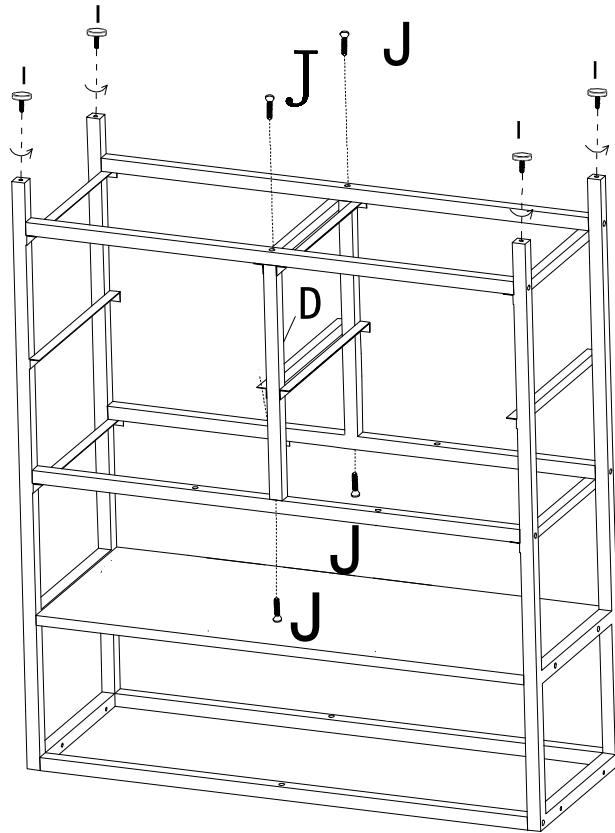

STEP 3:

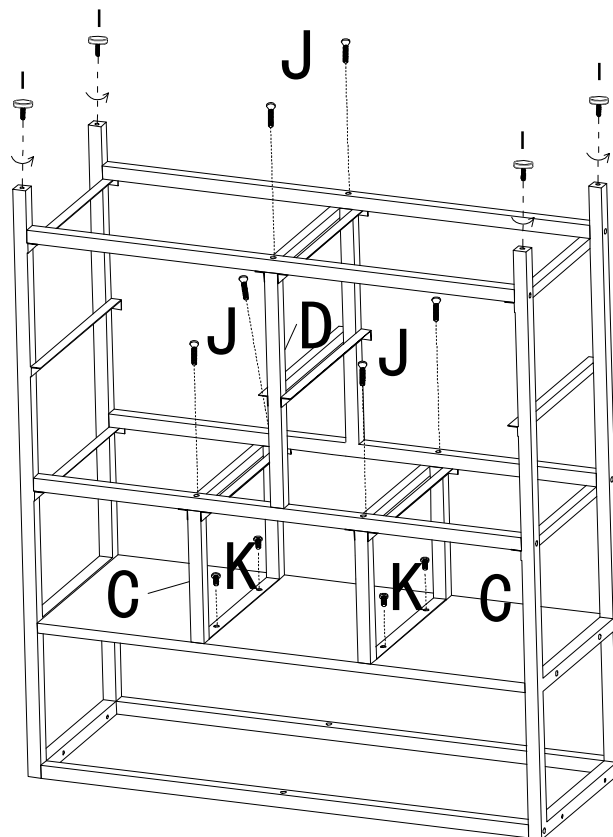

STEP 4:

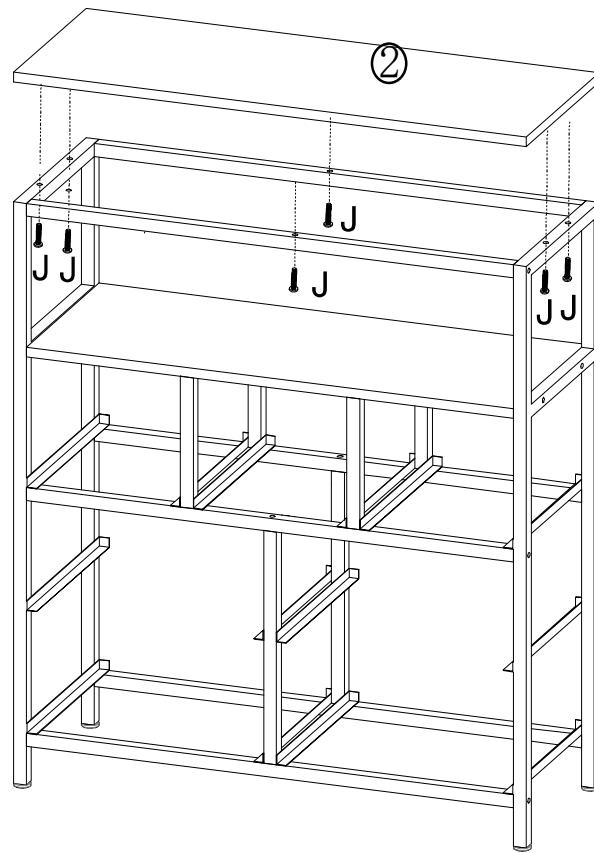

STEP 5:

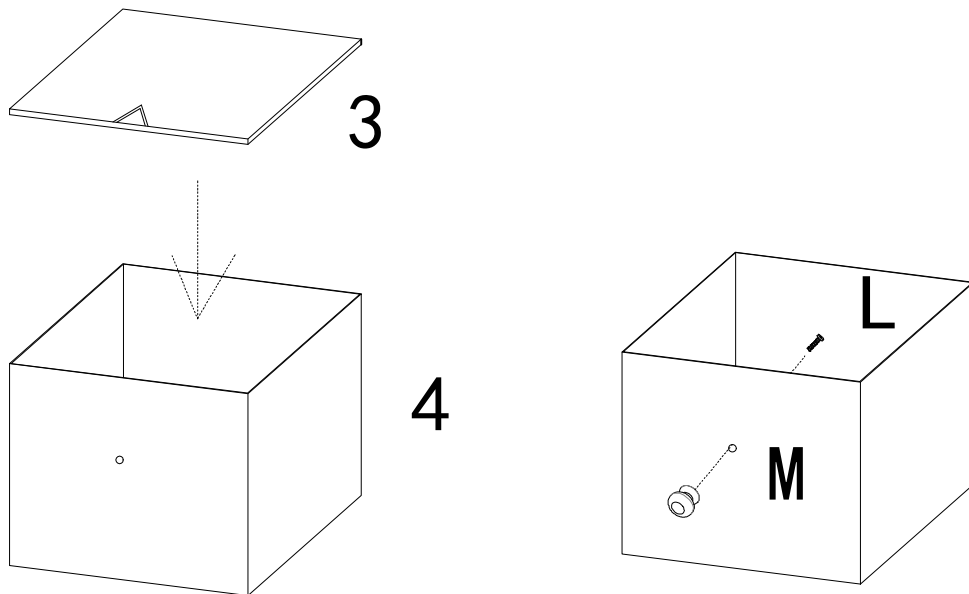

STEP 6:

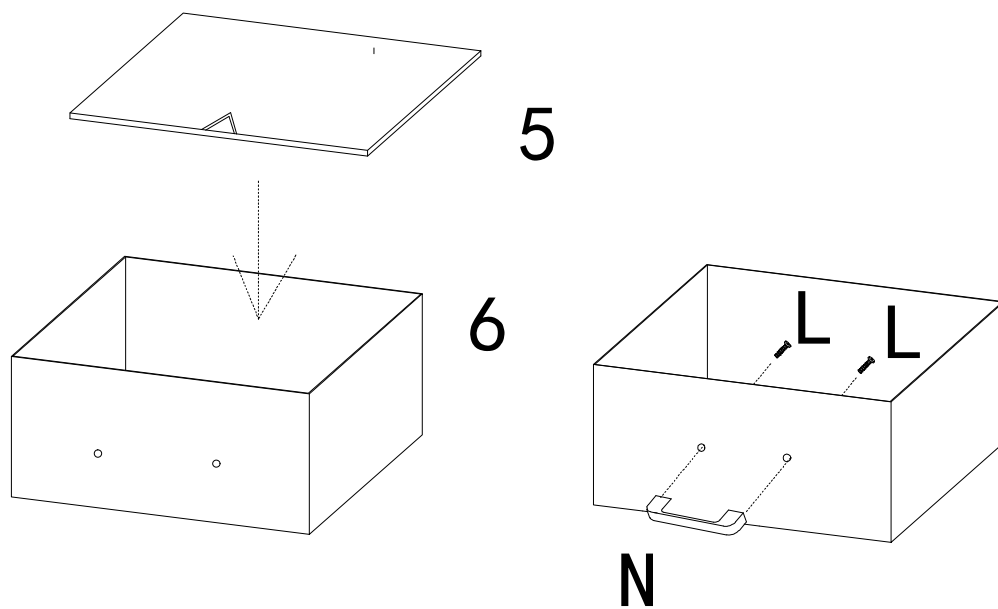

STEP ; 7

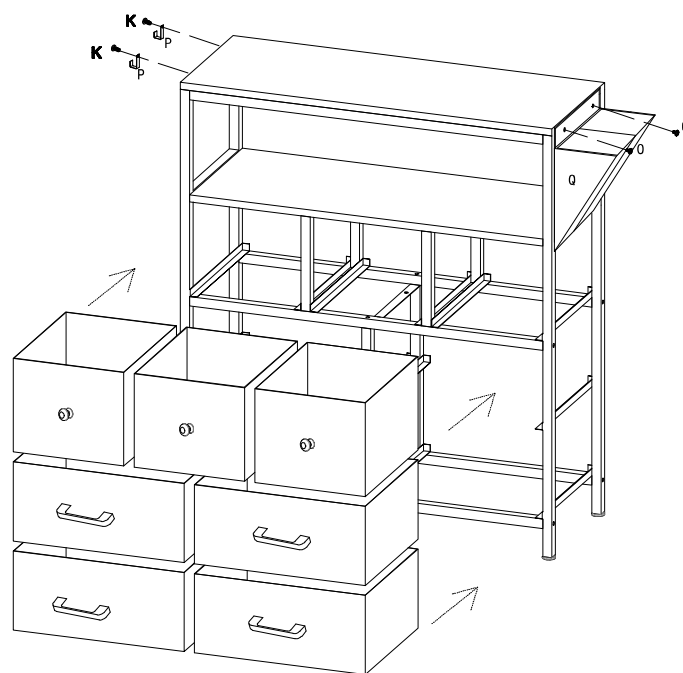

· STEP8:

