

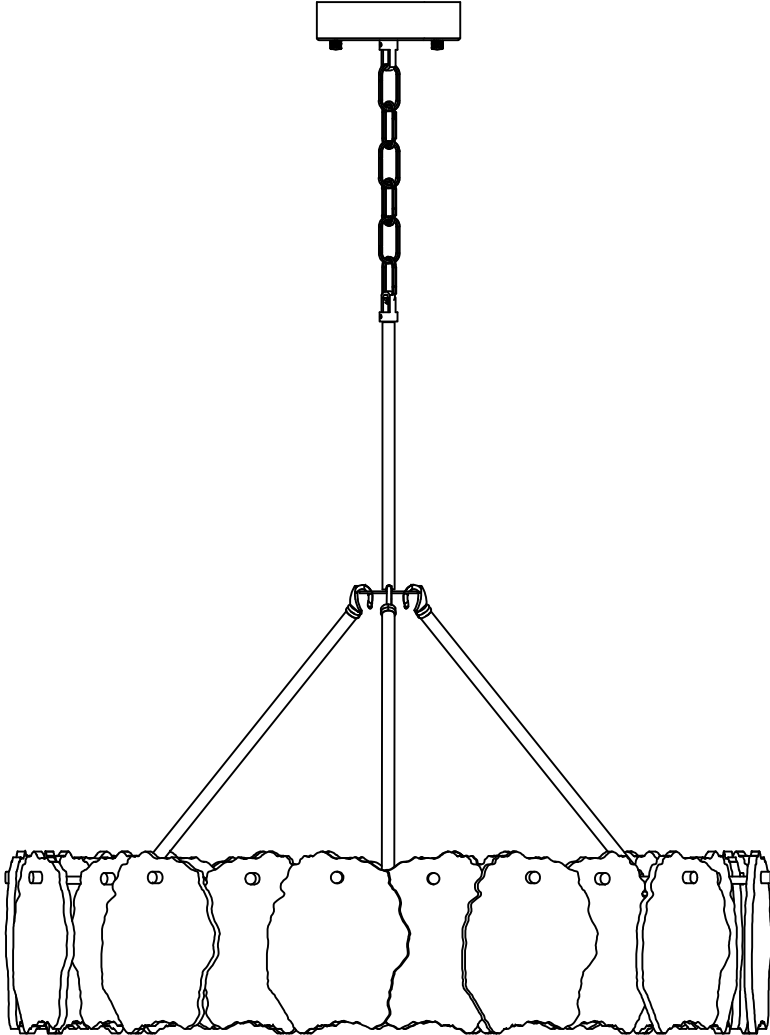







INSTALLATION MANUAL

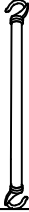
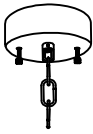

parts list

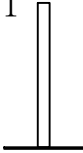
A*4 	B*4 	C*3 	D*2 	E*3 
F*1 	G*24 	H*1 	I*1 	J*24 

STEP I Unpacking

Open the box, and take out all the accessories, you will get the following items.

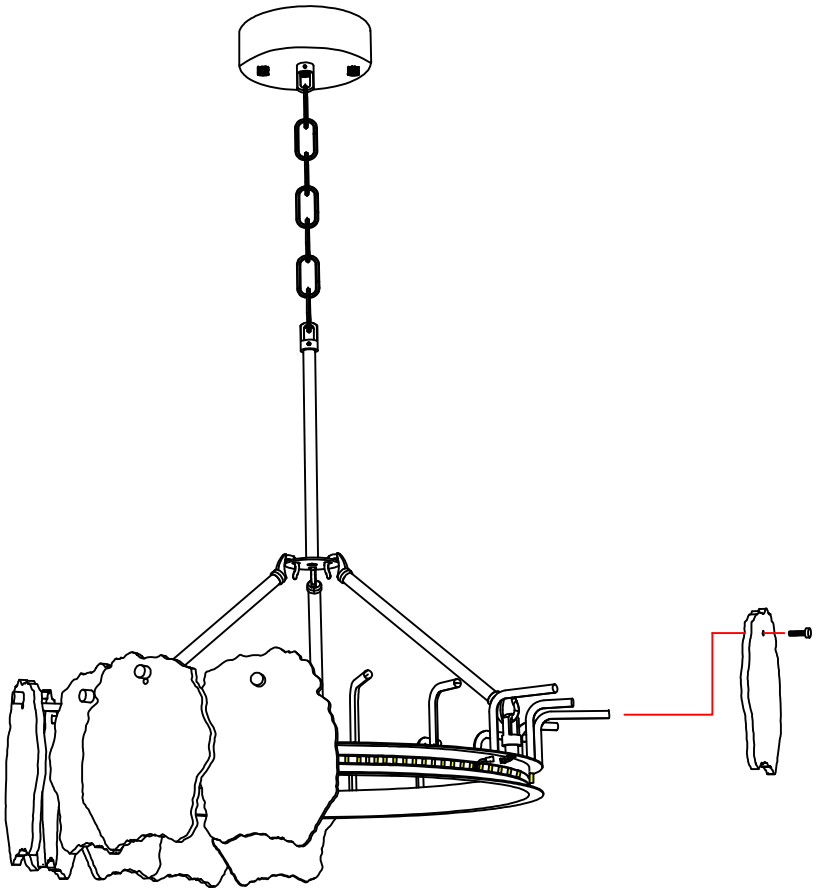

FAQ

Q: When I open the box, I find that the Spanish marble fittings are broken, what should I do?

A: Since Spanish marble lampshade fittings are handmade and inherently fragile, we have taken this situation into consideration. We have prepared spare glass fittings in each box, which is sufficient for your installation needs. If there are extra broken Spanish marble fittings fittings, please contact us in time, we will send new Spanish marble fittings to you.

STEP II Branch Adjustment

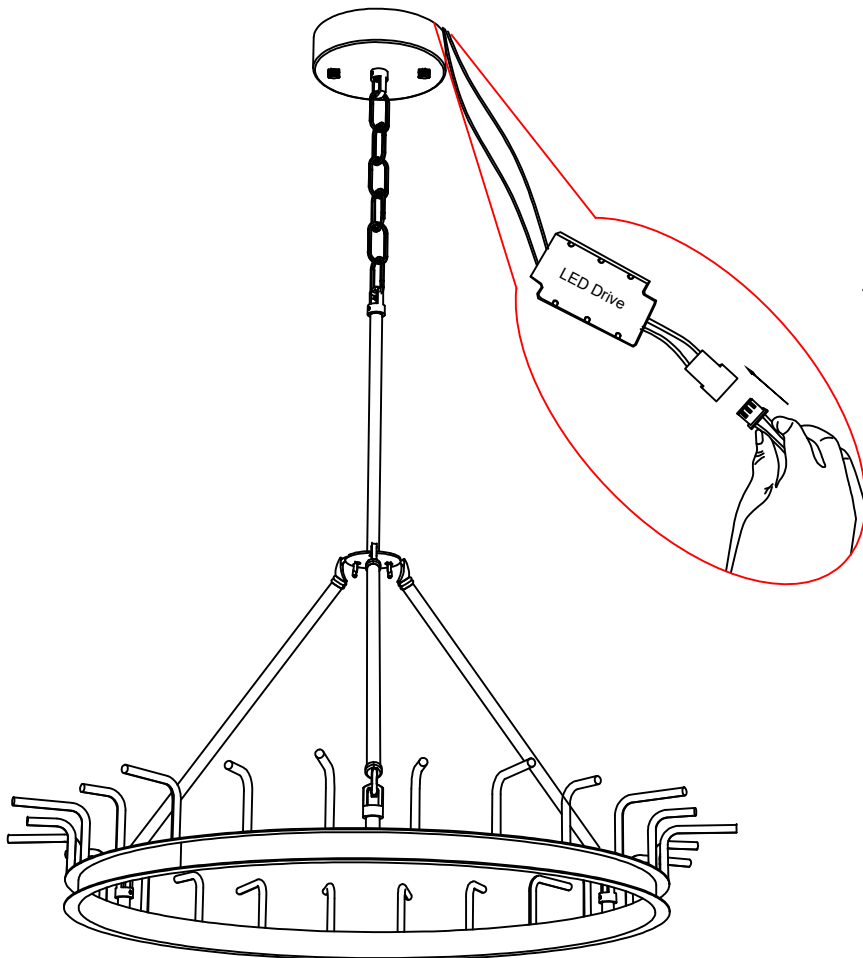

FAQ

Q: Do I need to install the iron pipe components in order ?

A: No, you need to use the movable clips to fasten to the lamp body and lock the screws into place.

STEP III Wiring and Mounting

1. Adjust the length of hanging cable and wire according to your requirement.
2. Take off the mounting bracket from ceiling canopy, and install it on ceiling.
3. Connect lamp wires and your house wires together.
4. Install the lamp frame on ceiling.

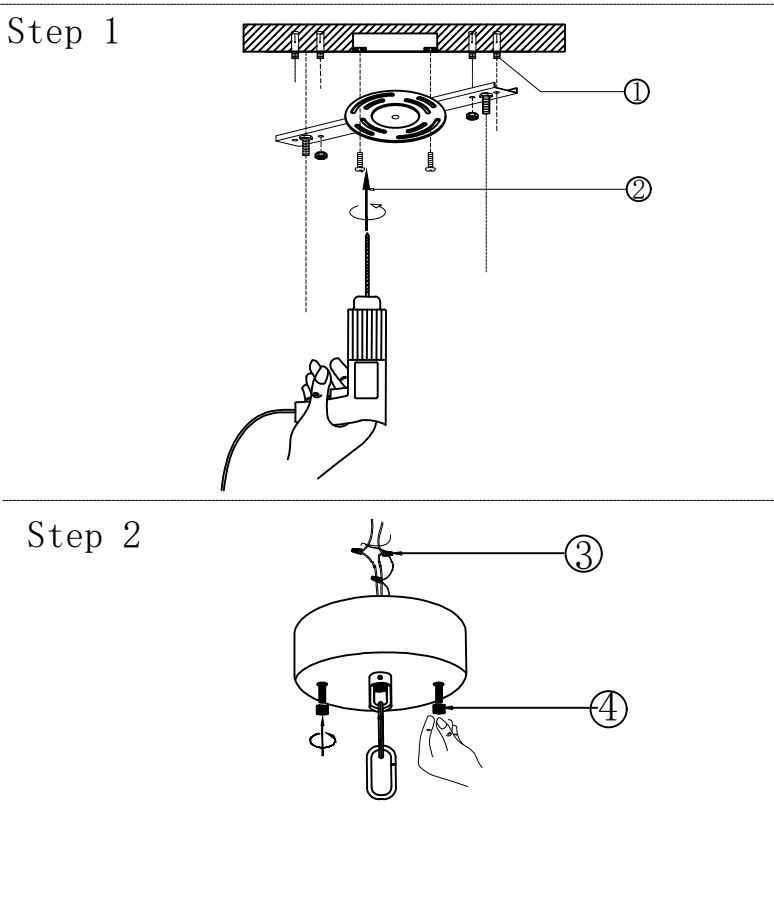

FAQ

Q: How do I differentiate between Neutral wire, Live wire and Ground wire?

A: We have distinguished markings between the N and L wires and the brass wire on the mounting bracket is the ground wire.

STEP IV Hanging Pendants

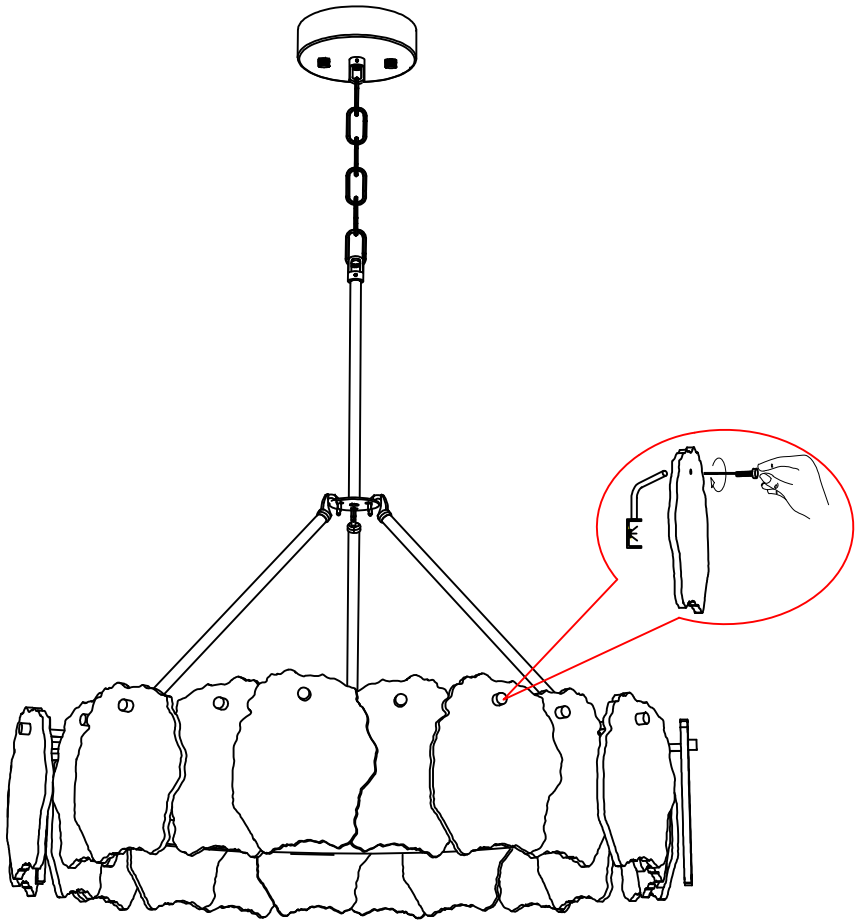

FAQ

Q: What do I need to pay attention to when I install a Spanish marble?

A: Since Spanish marble is fragile, we simply place the Spanish marble gently on the matching lamp body to prevent them from falling off.

No matter what problems or questions you encounter during the installation or use of the chandelier, please feel free to contact us, we will reply to you within 24 hours and quickly solve or answer for you!
When you leave a message to us online, please leave your order ID and case details. The more detailed and accurate descriptions you provide, the faster and more accurate solutions we will offer!



SAFETY INSTRUCTIONS

These instructions are provided for your safety. It is very important that you have read them completely before beginning the installation of your fixture.

1. We recommend installation by a licensed electrician.
2. This fixture is an LED light source
3. If any special control devices are used with this fixture, follow the instructions carefully to assure full compliance with N.E.c. requirements. If there are any questions, contact a qualified electrical contractor.
4. Please make sure shut off the main electrical supply before installation changing bulbs or cleaning light fixture.



WARNINGS

This is not a toy and the product has no play value.
Keep at least 3 ft away from cribs, bassinets, and toddler beds.
Keep out of reach of children under 3 years old.



PREPARATION

1. Please prepare the LED bulb of the packing in advance.
2. Please keep the installation place clean and tidy to avoid missing tiny accessories.