

Owner Manual

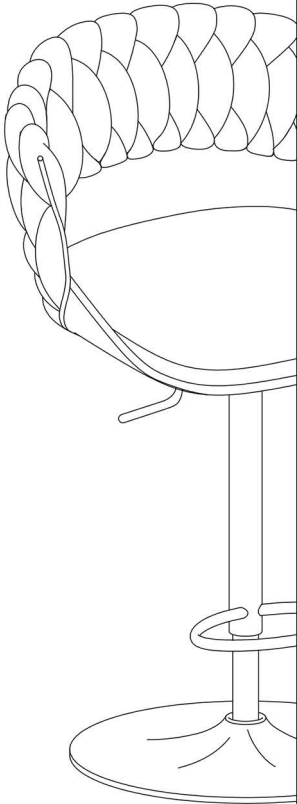



WARRANTY

We strive to offer high quality product and we also try our best to satisfy each customer that order from us, no matter on products or services as needed. Each customer receives a record of their order, such as the order number or item receipt. For any items that are out of warranty period, you may still be able to purchase the replacement parts from our company if they are available.

MAINTENANCE AND WARNING

Please read the manual thoroughly
before you start installing.

Please keep the product away from
sharp object.

Packaging and small parts may have
chocking hazard, please keep them away
from children and pets.

Please clean the product according to each
clean code, check the product description
for more information.

Please keep the product away from fire.

If you have any other questions, please
contact us, we will be glad to help you out.

If the product is placed under direct
sunlight, the pattern or color might fade
away overtime.

Check the product periodically to make
sure everything is secured and tightened.

Always use proper tools for installation.

Do not jump on the product.

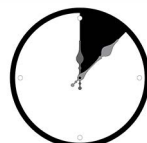

PRODUCT DESCRIPTION

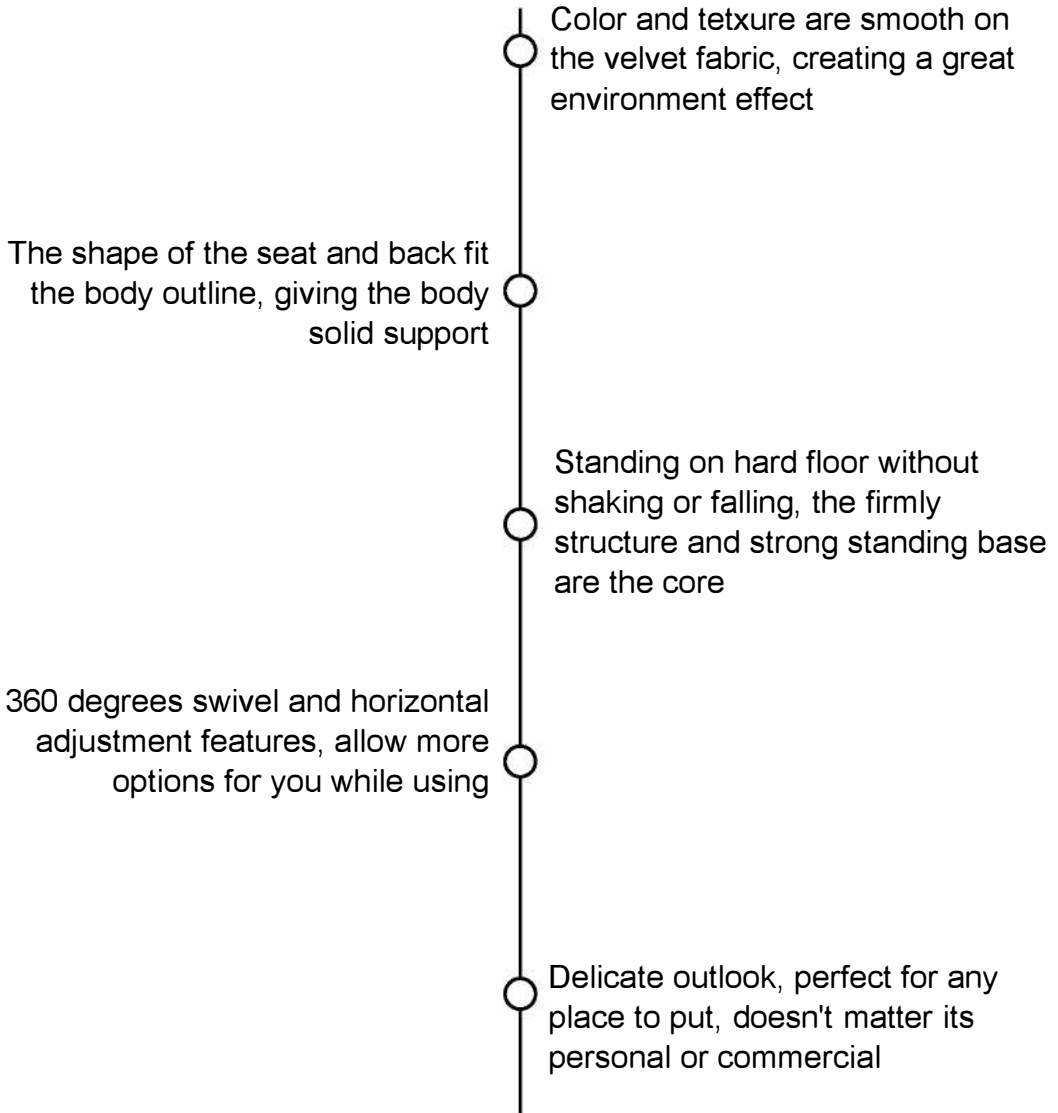

EXPLODED VIEW

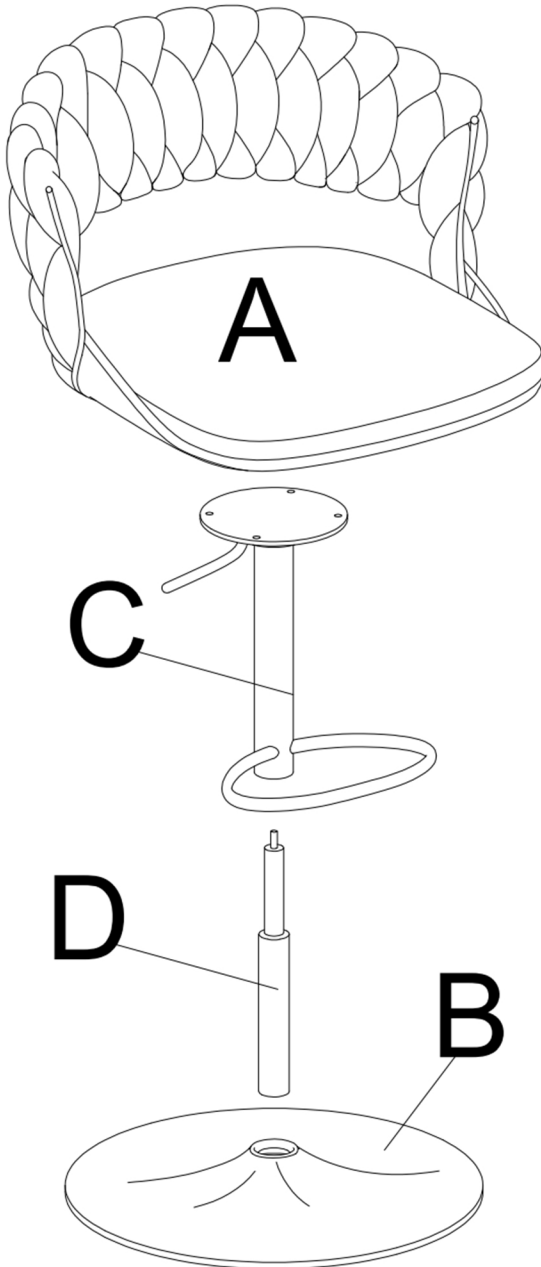

PARTS

A*2

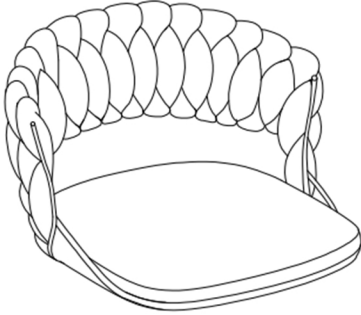

Seat frame

B*2

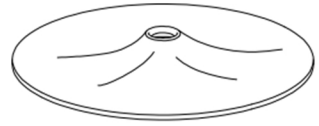

Base

C*2



Mechanism

D*2



Gas lift

HARDWARE

TOOL LIST

NOTE: Designated with (★) We provide additional spare parts in the hardware package

①*8



★ Bolts

②*1

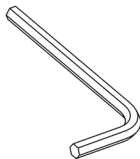

Allen key

Please make sure all hardware&packing material fitting the list. Especially some small accessories may be missing during transportation. Please contact us if you have any question.

step 1

Place the seat frame upside down on a clean surface, then install the mechanism onto the bottom of the seat frame as shown. Use the allen wrench provided to tighten all four bolts, make sure the bolt holes on seat frame and mechanism are correctly aligned before fully tighten. Please make sure the arrow points to the front of the chair before install.



Notice:

We suggest tightening the bolts for 30-50% first, make sure the process is correct and bolt holes are aligned, then fully tightening them all.

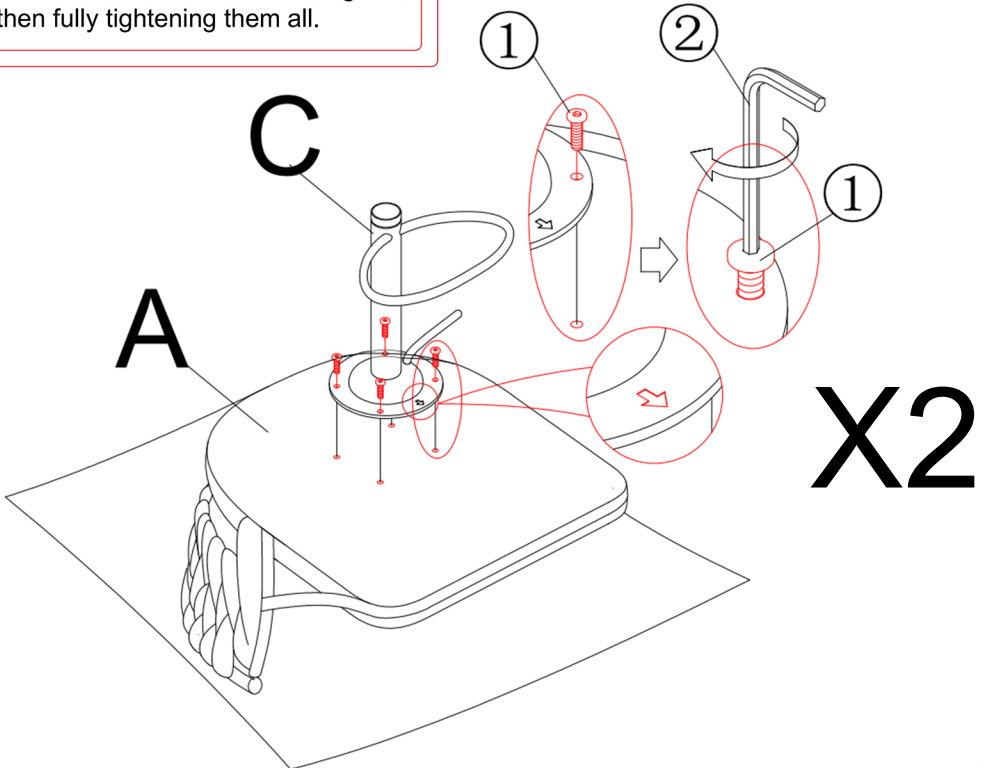

step 2

Remove the plastic cap from the tip of the gas lift as shown, then insert the gas lift to the hole on the base. Apply some force to push the gas lift down until its locked. Then install the top part of the bar stool to the gas lift as shown, insert the gas lift into the mechanism.

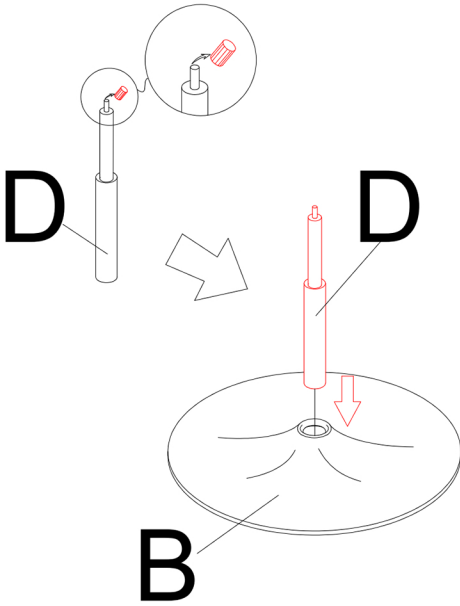

X2

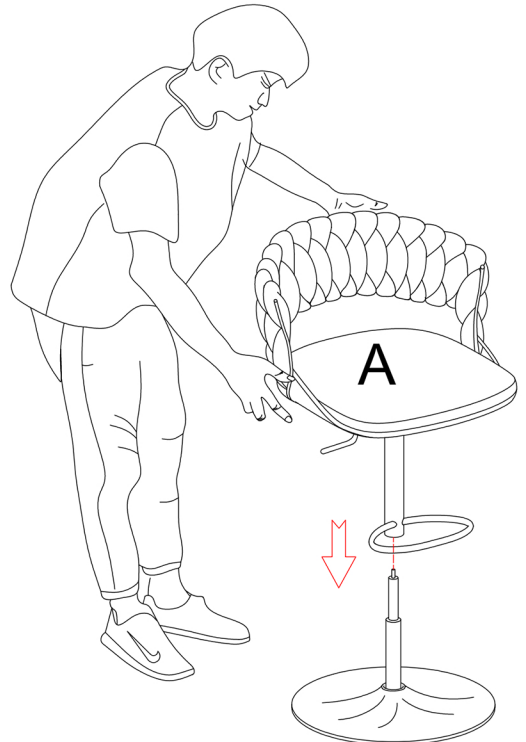

step 3

The gas lift can be adjusted by pulling the handle on the side as shown, in order to adjust the height of the stool.

