

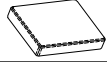







ASSEMBLY INSTRUCTIONS

30044 STOOL

PARST LIST

No.	DESCRIPTION	SKETCH	Q'TY
A	STOOL SEAT FARM WITH CUSHION		2PCS
B	LEFT STOOL LEGS		4PCS
C	RIGHT STOOL LEGS		4PCS
D	STOOL FRONT & BACK STRETCHER		4PCS
E	STOOL SIDE STRETCHER		4PCS

HARDWARE LIST

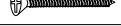
NO.	DESCRIPTION	SKETCH	Q'TY
1	ALLEN KEY 4MM		1PC
2	BOLT Ø1/4"*50MM		8PCS
3	SPRING WASHER Ø1/4"		8PCS
4	FLAT WASHER Ø1/4"X19MM		8PCS
5	SCREW 45MM		16PCS

Step:1

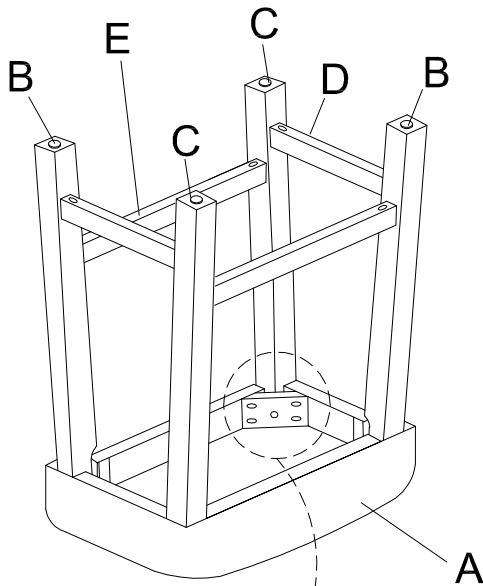

Step:2

