

# ■ ■ Bar Stool

## ASSEMBLY INSTRUCTION

---



Dear customer, Thank you very much for buying our items. Please read the assembly instruction carefully before assembly.

## Notices:

- Verify that all parts are present and in good condition before assembly.
- Put the barstool on a clean flat surface.
- Please tighten the screws to about 80% for the first step; Then, sit with caution on the barstool to adjust the balance; Finally, tighten all the screws to 100%.
- If you find that is unlevel after assembly, you can use adjustable pegs to keep four legs level.

## Contact us

If there are installation problems, damage, missing parts, or any questions and concerns, please contact the shop where you bought it so we can make things right.

If the product is damaged, please send the following information:

- Photos that show the reason for your claim/damage.
- Photos of the packaging (inside and outside).

Thank you very much for your support!

# Package Contents

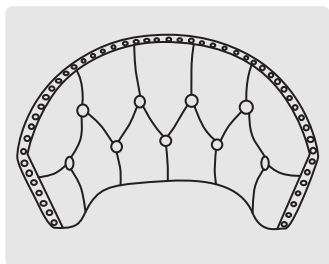

Back

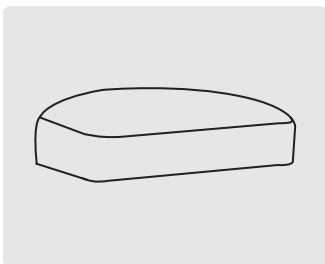

Seat

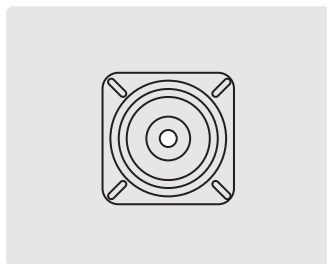

Swivel Plate

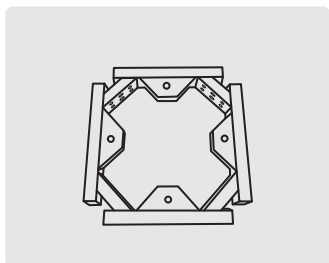

Wood Frame

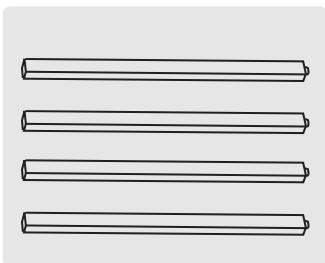

Legs

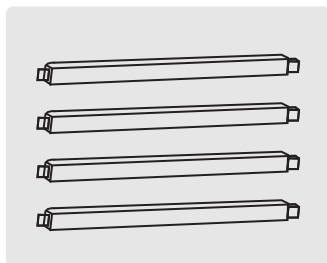

Crossbar

A × 11



Flat Washer

B × 8



Lock Washer

C × 1

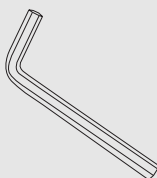

Allen key

D × 8



M6x20mm  
Screws

E × 8

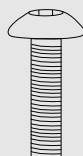

M8x60mm  
Screws

F × 3

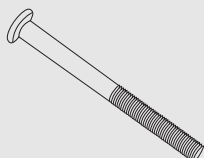

M8\*120mm  
Screws

G × 8



M4x50mm  
Screws

## Step by Step Guide

1

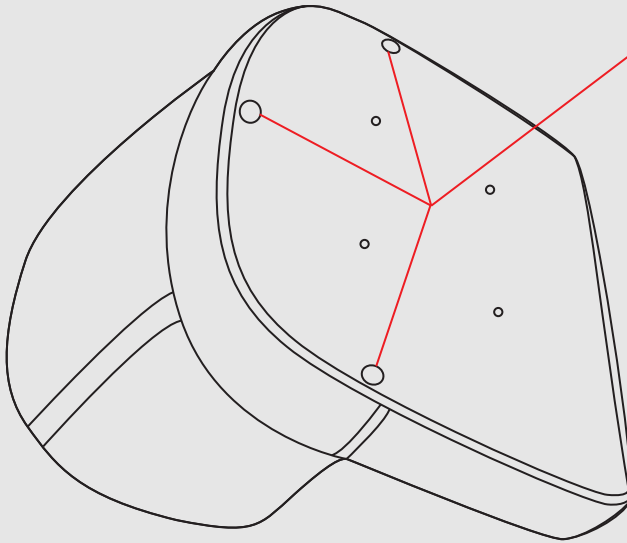
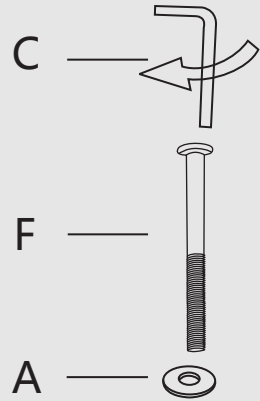

Align the back with the holes of the seat by using long screw (F) with washers (#A).  
Tighten them up to 100%

## Step by Step Guide

2

Step 1

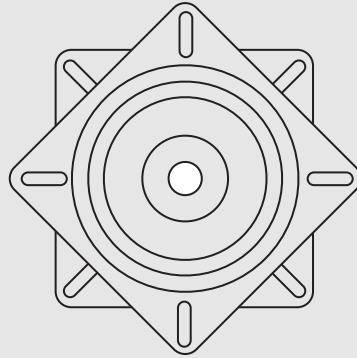

Step 1: Rotate the swivel plate as shown

Step 2

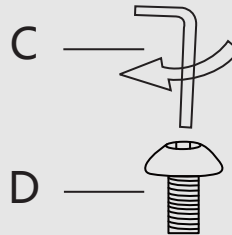
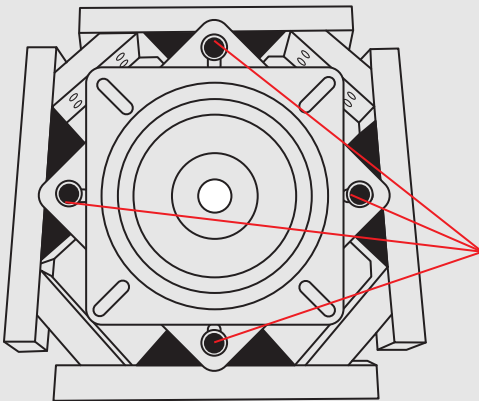

Step 2: Align the swivel plate with the holes of the wood frame by using screw (D)  
Tighten them up to 100%

## Step by Step Guide

3

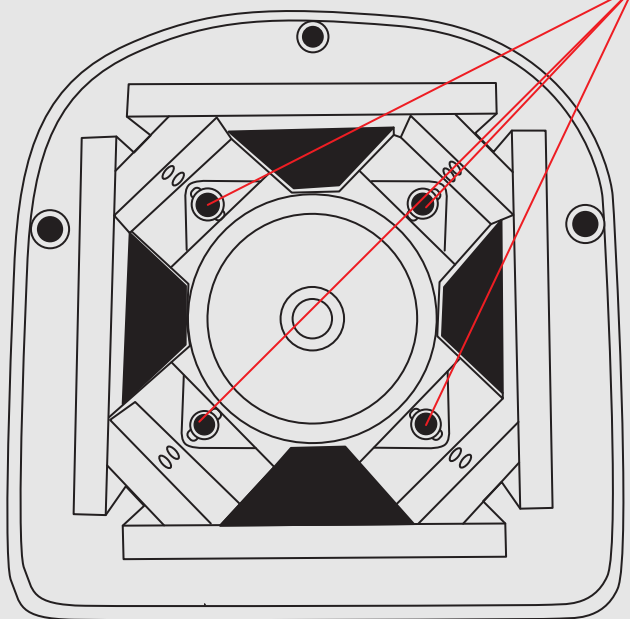
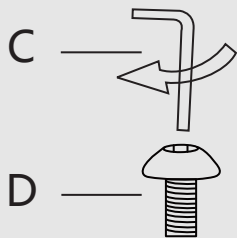

Align the wood frame with the holes in the cushion using screws (D)  
Tighten them up to 100%

## Step by Step Guide

4

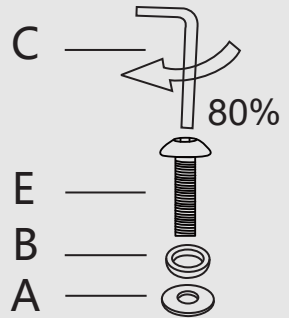

Align the legs in to the holes of the seat by using the screw (E) with washers (#A, B). Tighten the screws, just tighten them up to 60-80%.

## Step by Step Guide

5

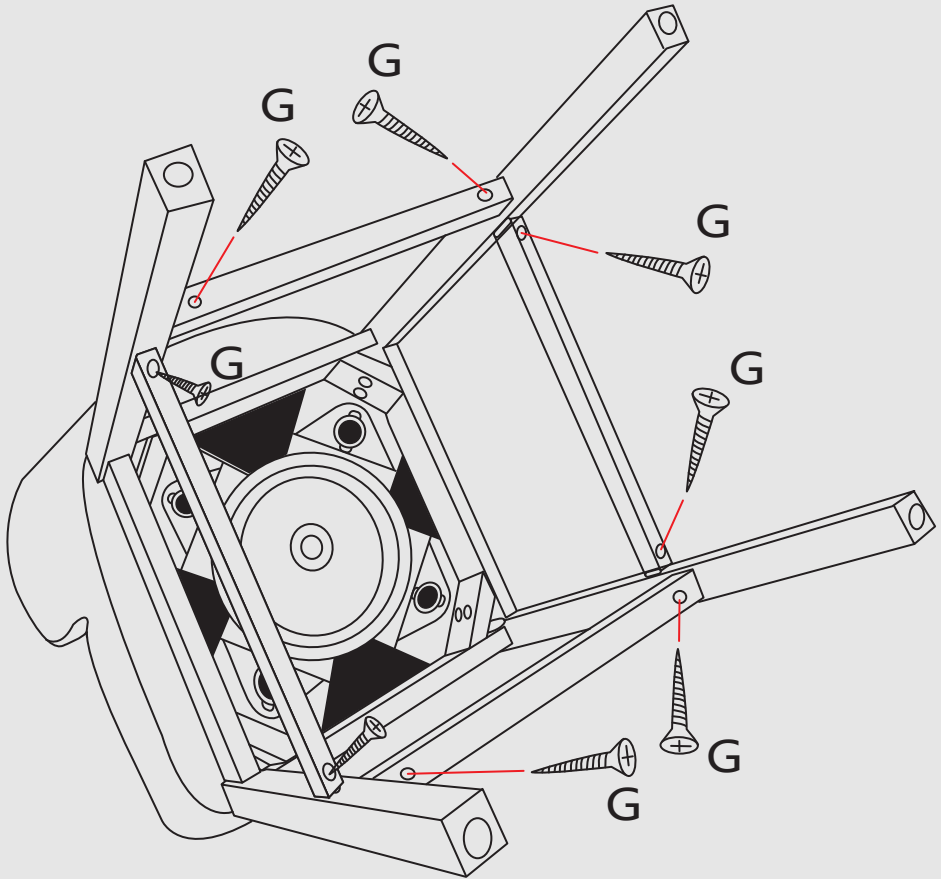

Align the crossbar into the holes of the both sides of front legs by using screws (G)  
Tighten all 8 screws at the same time. Just tighten them up to 60-80%.

## Step by Step Guide

6

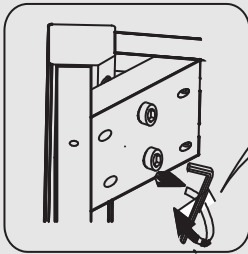
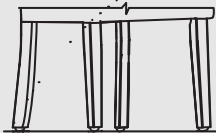
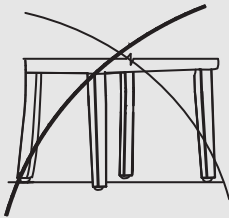

**100%**

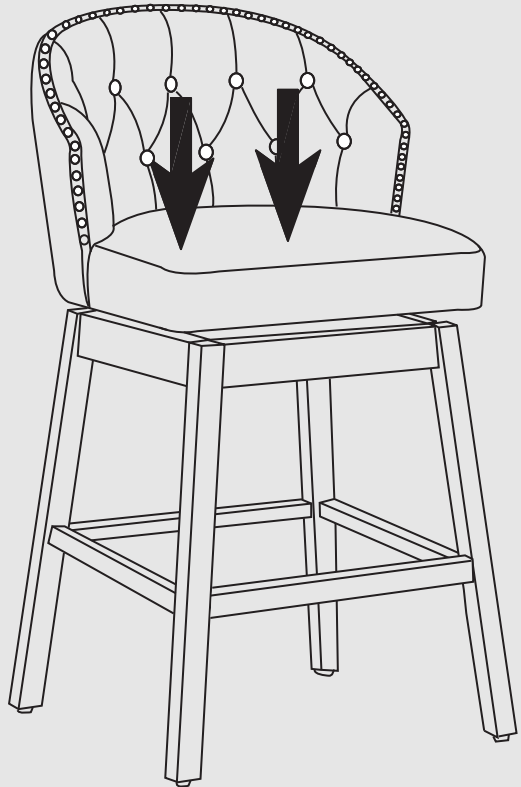

Please put a heavy object or one adult sit on and make sure the chair legs are assembled correctly and stable.

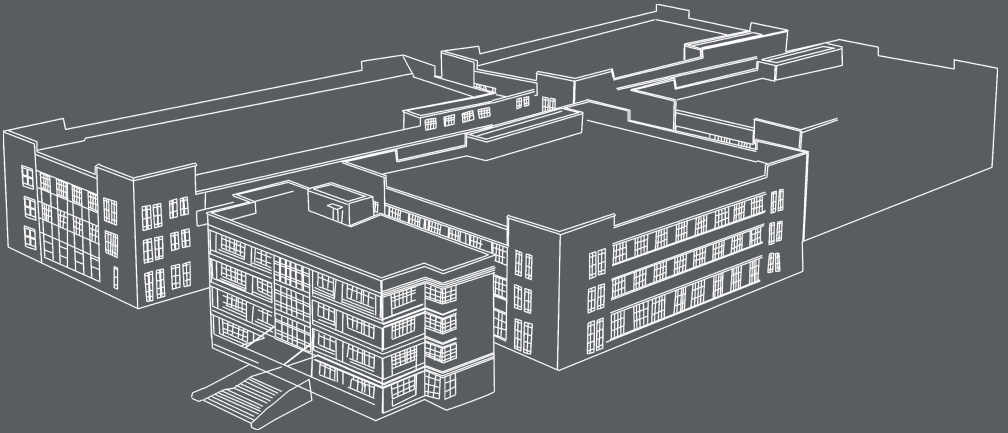

## About us

We are a professional manufactory for making and selling dining chairs. In the past 15 years, we have exported millions of chairs to Europe and USA.

We focus on providing you with high-quality products that meet international standards. To ensure timely shipping, we have built large warehouses in California, New York, and Georgia.

## Contact us

The fastest way to get more information about the deals!