

MARGOT SWIVEL CHAIR

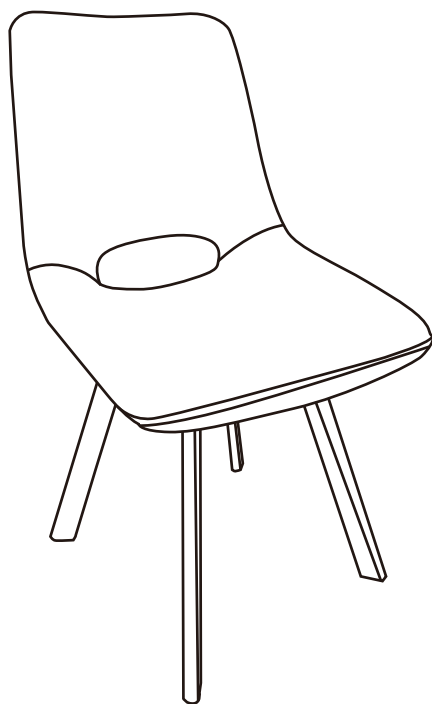

CONTENTS

Safety and care advice	1
Components	2
Assembly instructions	3
Copyright	5

⚠ SAFETY AND CARE ADVICE ⚠

PLEASE READ THESE INSTRUCTIONS CAREFULLY AND KEEP FOR FUTURE REFERENCE

- **Warning:** This unit weighs approximately 8kgs. Please lift with care.
- Check you have all the components and tools listed on pages 2 and 3.
- Remove all fittings from the plastic bags and separate them into their groups.
- Keep children and animals away from the work area, small parts could choke if swallowed.
- Make sure you have enough space to layout the parts before starting.
- Do not stand or put weight on the product, this could cause damage.
- Assemble the item as close to its final position (in the same room) as possible.

- Assemble on a soft level surface to avoid damaging the unit or your floor (use opened out unit carton).



- We do not recommend the use of power drill/drivers **for inserting screws**, as this could damage the unit. Only use hand screwdrivers.
- Dispose of all packaging carefully and responsibly.

CARE AND MAINTENANCE

- Only clean using a damp cloth and mild detergent, do not use bleach or abrasive cleaners.
- From time to time check that there are no loose screws on this unit.

- This product should not be discarded with household waste. Take to your local authority waste disposal center.

Note *If required the next page can be cut out and used as reference throughout the assembly. Keep this page with these instructions for future reference.*

COMPONENTS

Ensure the following components are in the box before proceeding with assembly:



A

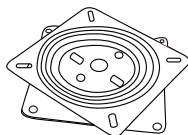

Swivel Mechanism x 1

F



Metal washer x 9

1



Seat x 1

B

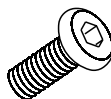

Screw M6*18mm x 2

G

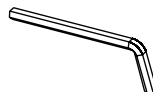

Allen Key x 1

2

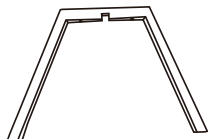

Upper legs x 1

C

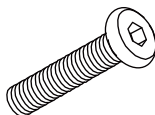

Screw M6*25mm x 2

H



Screw nut x 4

3

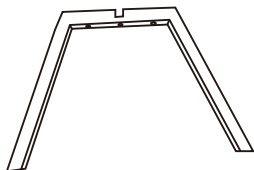

Lower legs x 1

D

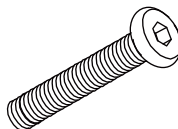

Screw M6*50mm x 4

I



Wrench x 1

E

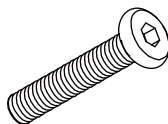



Screw M6*40mm x 1







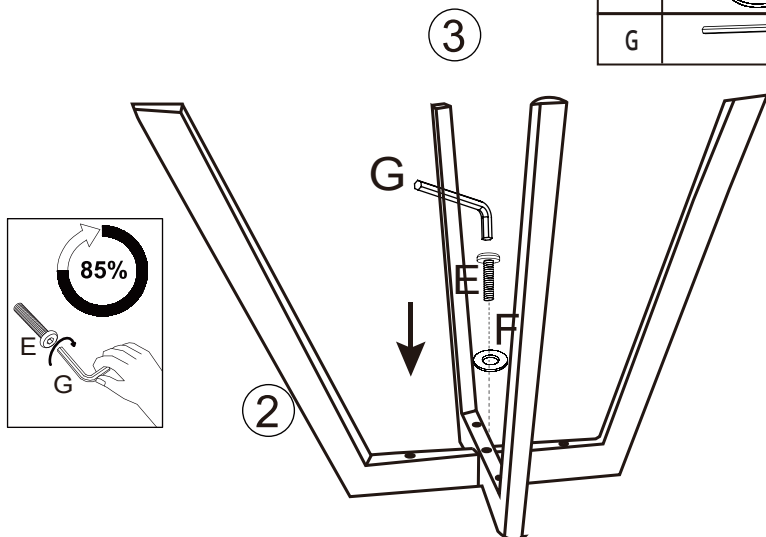

ASSEMBLY INSTRUCTIONS

Step 1

E		1
F		1
G		1



Step 2



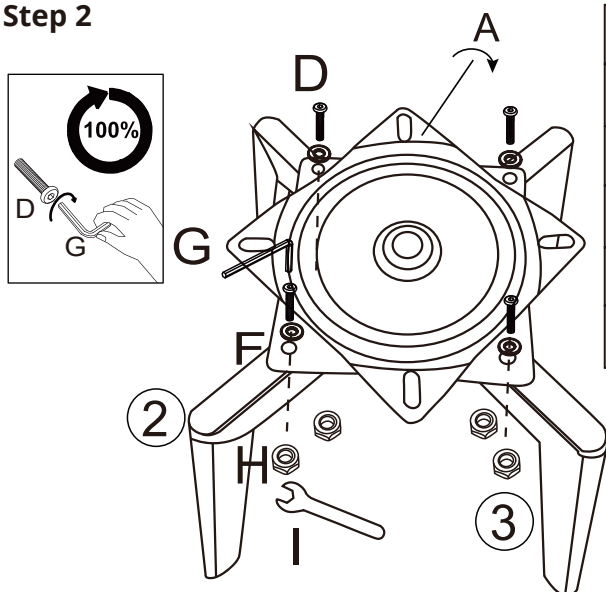

A		1
D		4
F		4
G		1
H		4
I		1

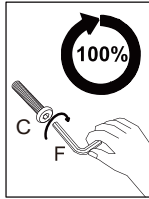
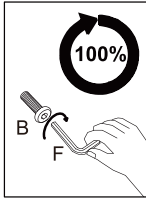

ASSEMBLY INSTRUCTIONS

Step 3



B		2
C		2
F		4
G		1

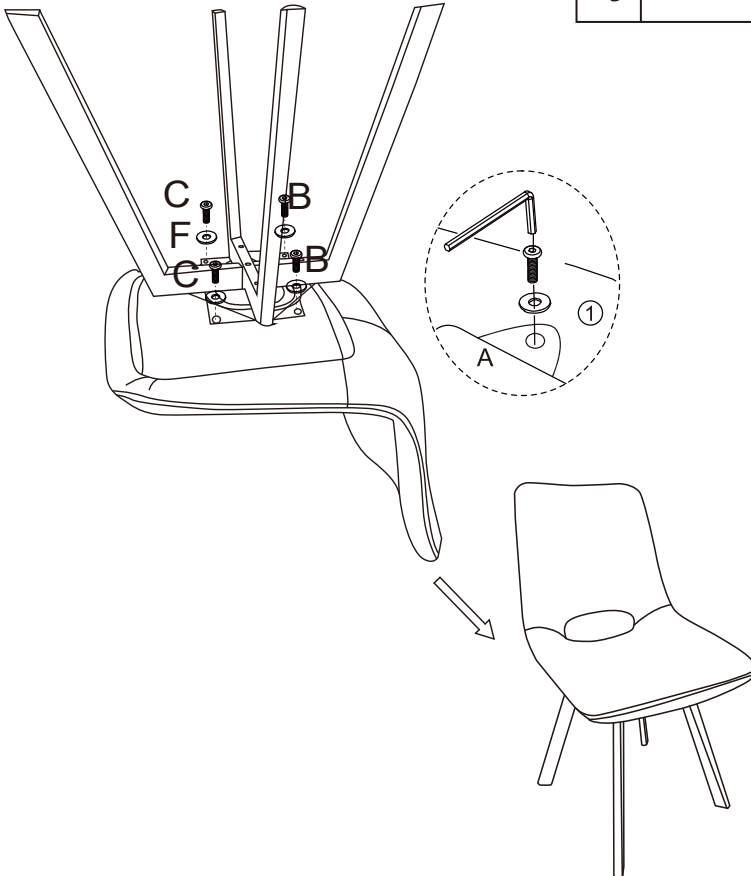

Congratulations! Now you have finished assembling the product.

IF YOU FIND A DEFECTIVE PART

We fully stock all parts and components. Any defective part can be quickly replaced. Take note of the defective part number in manual and we will arrange a replacement.

You can email our team

COPYRIGHT

All material in this instruction manual is copyrighted by AGTC Ltd.

Any unauthorised use may violate worldwide copyright, trademark and other laws.