

# Bazyths



## ENJOY YOUR NEW BAZYTHS SMART TOILET

Please contact Bazyths Support if you have any questions.

### Contact Information:

support@bazyths.com  
www.bazyths.com

Bazyths  
www.bazyths.com  
support@bazyths.com

# INSTRUCTION

## SMART TOILET

Concealed cistern series

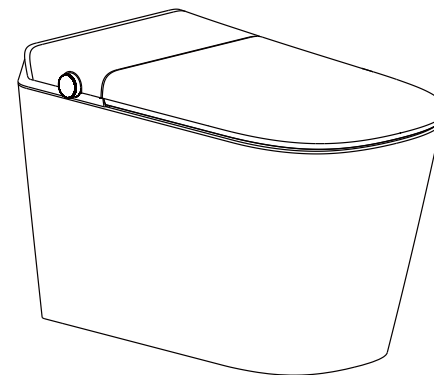

Thank you for purchasing our product.

Before using, please read the instruction carefully.

Please keep the instruction properly for further reference.

## Catalogue

Packing List .....	02
Installation of the Battery Box .....	04
How to Use Foam Shield & Toilet Bowl Cleaner Tablets.....	05
Component Name .....	06
Function Introduction .....	07
Cautions .....	08
Installation Instruction .....	11
Preparation before Use .....	16
Panel Cognition .....	17
How to Use .....	20
Function Setup and Adjustment .....	21
Cleaning and Maintenance .....	26
FAQ .....	30
Function List .....	31
Product Specification .....	32
Acceptance Record .....	33

## Packing List

Please check that the following items are included in the package.

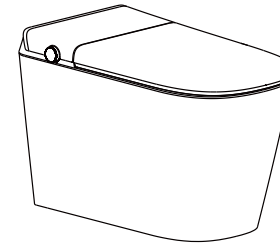

Smart Toilet

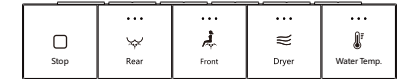

Remote Control & Mounting Bracket

Requires 2 alkaline AAA batteries (batteries not included).

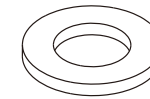

Wax Ring Gasket



Locking Screw Kit

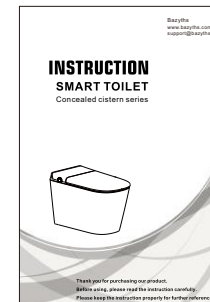

Instruction Manual

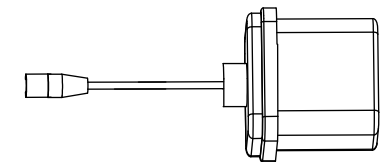

Backup Battery Box for Power Outage Flush

Requires 10 AA alkaline batteries to enable flushing during a power outage (batteries not included).

## Packing List

Please check that the following items are included in the package.

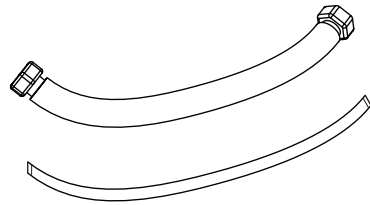

1 Braided Hose (for Flushing Water)  
1 Plastic Hose (for Cleansing Water)  
(Pre-installed)



Spare Part: 3/8" Female  
x 1/2" Male Adapter

If your existing shut-off valve has a 3/8" outlet, use this spare part to connect it to the smart toilet without replacing the valve.

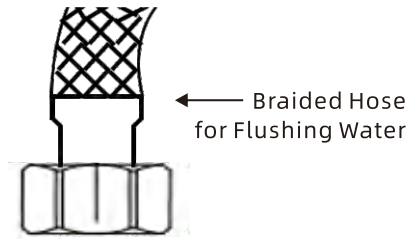

Braided Hose  
for Flushing Water

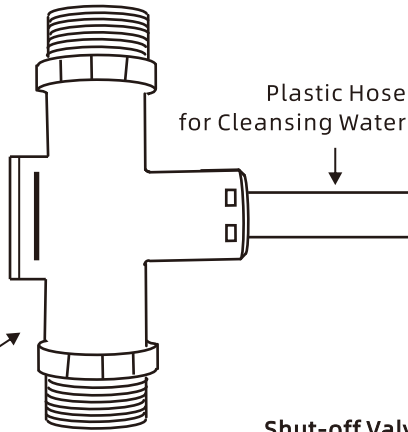

Plastic Hose  
for Cleansing Water

## Shut-off Valve & T-Valve

T-Valve  
with Filter

Shut-off Valve

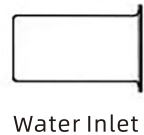

Water Inlet

1/2" Nom Outlet

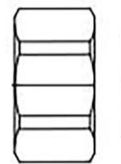

1/2" Nom/Comp Inlet

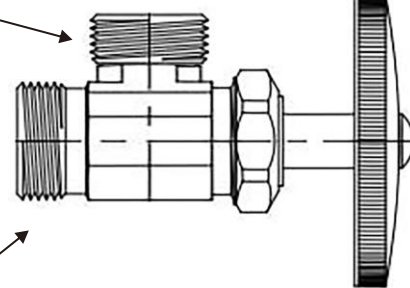
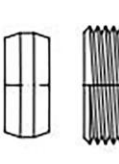

## Installation of the Battery Box

### Installation of the Battery Box for Power Outage

1. This battery box is intended for use as a backup power source during outages. **Do not use the battery box while the toilet is connected to a plugged-in power source.** It is recommended to connect the battery box to the main unit only during power outages. We are not liable for any damage or malfunction caused by using both power sources at the same time. Such usage is not covered under warranty.
2. Before using the flushing function during a power outage, install 10 AA alkaline batteries. (Batteries are not included. Please purchase them separately.) Open the battery box with a screwdriver and install the batteries. Do **not** mix old and new batteries, different brands, or different battery types. Always replace all 10 batteries at the same time.
3. Install the batteries according to the "+" and "-" symbols shown inside the battery box. This battery box uses a series battery configuration—no single cell may be reversed. Incorrect installation may damage the battery box or cause safety risks such as leakage, explosion, or fire.
4. Connect the battery cable. Remove the battery connection cable from the back of the toilet seat and plug it firmly into the battery box.
5. Do not disassemble the battery box unnecessarily. After replacing the batteries, seal the box tightly. Moisture entering the box may cause corrosion and battery damage.
6. Always disconnect the battery box from the toilet when replacing batteries.
7. This battery box is not rechargeable. Do not attempt to charge it, as this could pose a safety hazard.

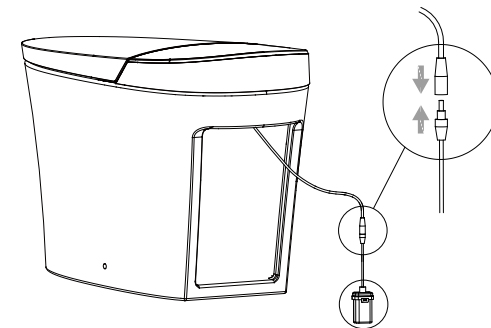

## How to Use Foam Shield & Toilet Bowl Cleaner Tablets

### ■ Introduction to the Foam Shield Function

The Foam Shield creates a soft foam layer inside the toilet bowl that prevents splashing, blocks odors, and keeps the bowl cleaner. It is an innovative feature designed to enhance hygiene and provide a more comfortable and pleasant bathroom experience.

### ■ How to Get Your Free Foam Shield Liquid

For transportation safety, the foam liquid is not pre-filled in the foam shield bottle. After receiving your toilet, please contact us at [support@bazyths.com](mailto:support@bazyths.com) to request the foam liquid. Your first bottle is completely free, and we will ship it to you separately.

### ■ Replace the Foam Shield Bottle

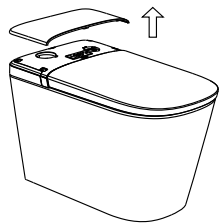

1. Hold both hands together on the left and right sides of the decorative cover, and lift it out vertically.

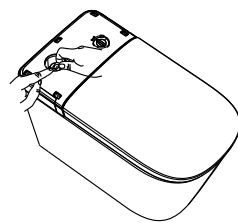

2. Press the connector cap and detach the soft tube.

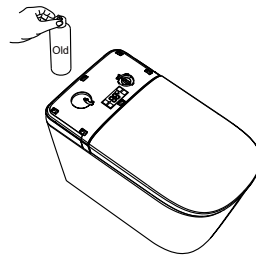

3. Remove the old bottle.

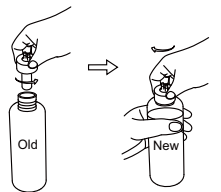

4. Take the connector head from the old bottle and attach it to the new bottle.

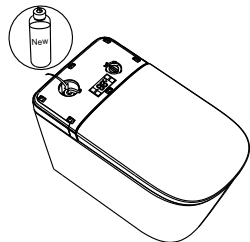

5. Place the new bottle back into the machine and reconnect the soft tube.

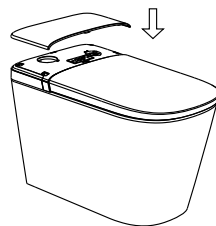

6. Secure the decorative cover back in place.

**Note:** Regardless of whether you use the Foam Shield function, please ensure that a foam liquid bottle is placed here and that the soft tube is connected to the bottle. Without a bottle, water leakage may occur.

## Component Name

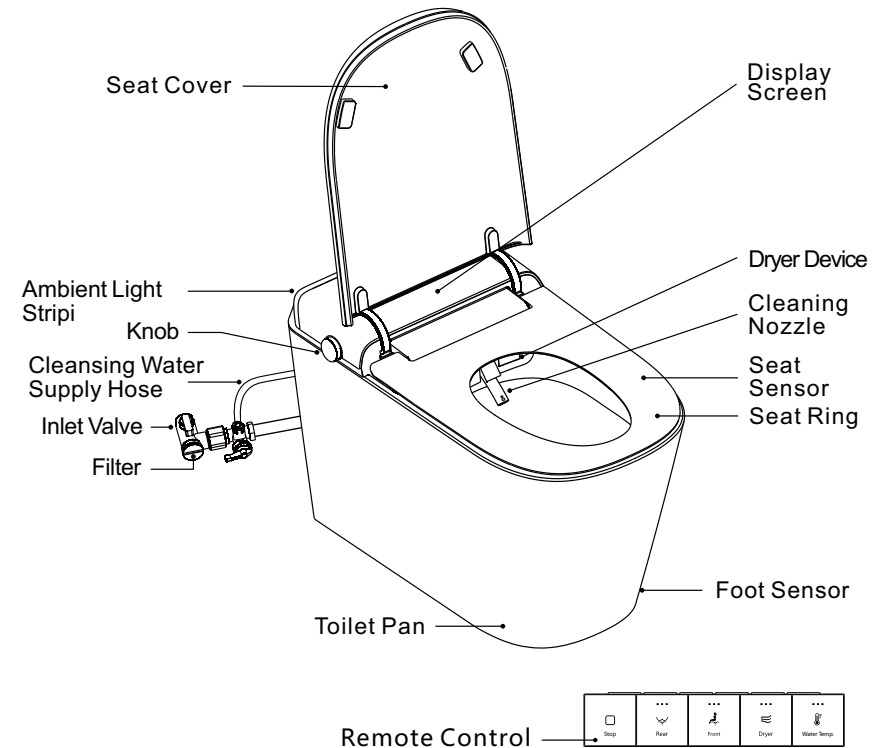

## Technical Drawing

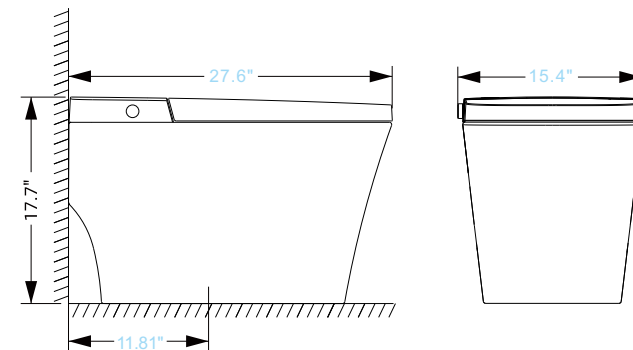

## Function Introduction

**Note:** Below functions can be adjusted or turned on/off using the remote control. Details will be provided later in this manual.

**Super Quiet Flushing**---- Flushing noise is below 45 decibels

**Auto lid**---Automatically open the lid when a user approaches the toilet.

**Foot Senser for Lid/Seat Opening** ---Automatically open the lid or seat when a user approaches.

**H/C massage**---Cleaning water alternates between hot and cold.

**Rear Cleansing**---Single hole nozzle for powerful rear wash..

**Moving Rear Cleansing**---Nozzle moves back and forth to expand cleaning range.

**Front Cleansing**---Gentle nozzle spray designed for female hygiene.

**Moving Front Cleansing**---Nozzle moving to wash with wide rang.

**Cleaning Strength Adjustment**--- Adjust the water pressure to your preference.

**Nozzle Position Adjustment**---Move the nozzle forward or backward for a customized position..

**Cleaning Water Temperature Adjustment** ---Choose from four water temperature levels: Low, Medium, High, or Normal.

**Warm Air Drying**---Gently dries the area after cleansing.

**Seat Sensor**---All functions are activated only when the seat is occupied.

**Seat Temperature Adjustment**---Four levels of heating: Low, Medium, High, or Normal.

**Smart Seat Temperature.** ---Automatically adjusts seat temperature based on seasonal conditions.

**Remote Control**---All functions can be operated via the remote control.

**Auto Flush**---Flushes automatically after use and upon standing up.

**Fremote Control Flush**---Press the flush button on the remote to initiate flushing.

**Foot Sense Flush**---Flushes the toilet using the foot sensor.

**Night Light**---Built-in light provides visibility for nighttime use.

**Nozzle cleaning**---Self-cleans the nozzle when the seat is unoccupied, ideal for routine maintenance

**Automatic Nozzle Cleaning**---The nozzle cleans itself before and after each use..

**Blackout Flush**---Operates flushing via built-in battery during a power outage.

**User 1 and User 2 Shortcut Settings**---Personalized memory settings for two users; switch modes with one click.

**Foam Shield** ---Provides deodorizing, splash-proof, anti-stick, and antibacterial protection.

## Cautions



### WARNING



NO DISASSEMBLE

**Do not disassemble, repair or modify this product.**

◆ Doing so may cause fire or electric shock.



NO WATER

**Do not unplug the device with wet hand.**

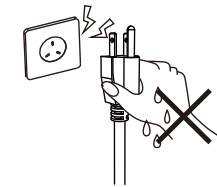

◆ Doing so may cause electric shock.



NO SOAKING

**Do not pour water, detergent, deodorant, or any liquid onto the product or power plug.**

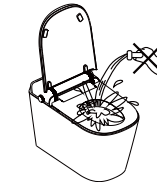

◆ Doing so may cause fire or electric shock.



PROHIBIT

**Support only 110V AC. Do not plug in the power until the the inlet valve open.**

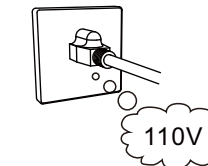

◆ Failure to follow this instruction may cause fire.



PROHIBIT

**Do not scratch, bend, twist, stretch, bind, or pinch the power cord. Do not use a loose or damaged socket.**

◆Doing so may damage the cord and result in electric shock or fire..



PROHIBIT

**Only use tap water or potable well water. Do not use any other water sources.**

◆May damage the unit or cause skin irritation



GROUND WIRE

**Ensure the unit is properly grounded.**

◆Grounding helps prevent electric shock in the event of malfunction or leakage.



PROHIBIT

**Do not use in wet or damp areas.**

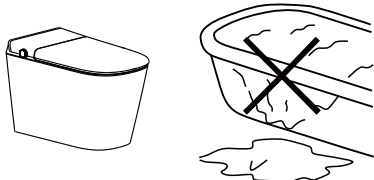

◆Risk of electric shock or fire.



ABIDANCE

**For prolonged use, set the seat temperature to the normal level.**

◆Prolonged use at +1 level may cause burns.



NO BURNING

**Keep away from fire.**

◆Easy to get on fire.



ABIDANCE

**Individuals with physical, sensory, or cognitive impairments, or those lacking experience or knowledge of this product (including children), should use it only under the supervision of a responsible person. Children should not play with this product.**

◆Improper use may result in burns, electric shock, fire, or injury.



PROHIBIT

**Do not operate the remote control with wet hands or allow water to spill on it..**

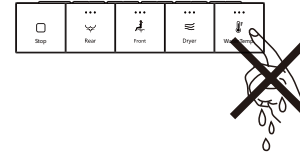

◆ Otherwise, it may cause remote control malfunctions.

## Installation Instructions

### ■ Installing the Smart Toilet

#### 1. Confirm the Installation Environment

Before installation, please ensure that the bathroom wall and floor tiles have been fully completed, and that the sewage pipes, water pipes, and electrical circuits have been reserved according to the diagram below.

This toilet requires a rough-in of **300 mm (11.81 in)**.

Water inlet pressure range: **0.15 MPa (dynamic) – 0.75 MPa (static)**

Recommended water inlet temperature: **39.2°F–95°F(4°C–35°C)**

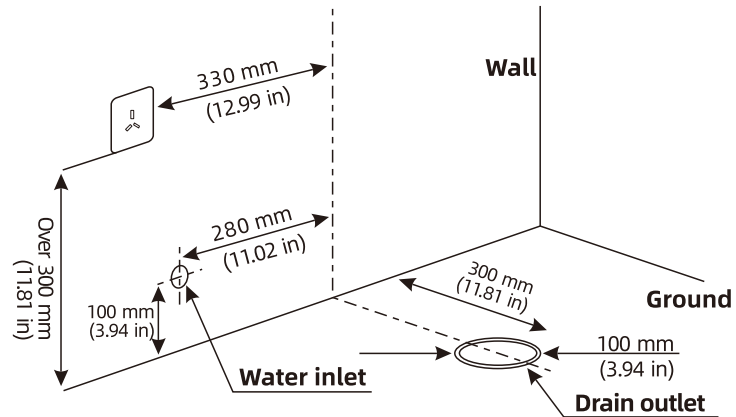

#### 2. Installing the Dedicated Shut-off Valve

Install the shut-off valve provided with the product.

- Note: If your existing shut-off valve has a 3/8" outlet, you may use the included spare adapter (Refer to page 3) to connect it the smart toilet without replacing the valve.

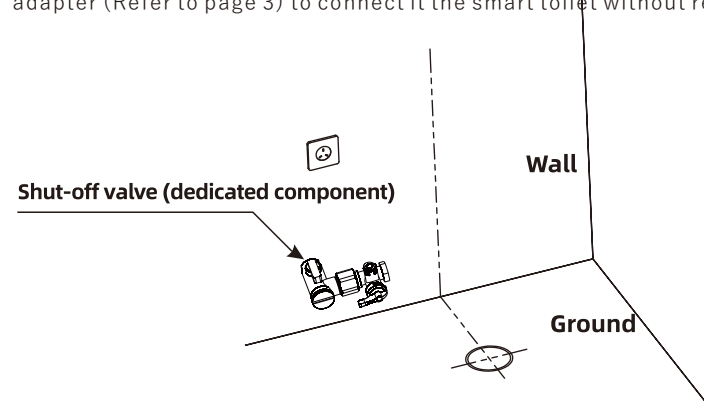

### 3. Toilet Installation and Fixation

(1.1) Assemble the mounting bracket using the provided bolts and secure it to the floor flange with nuts. **Please refer to Figure 1.0 on the next page for detailed assembly instructions.**

(1.2) Carefully place the toilet onto the mounting bracket, aligning it with the flange and bolts.

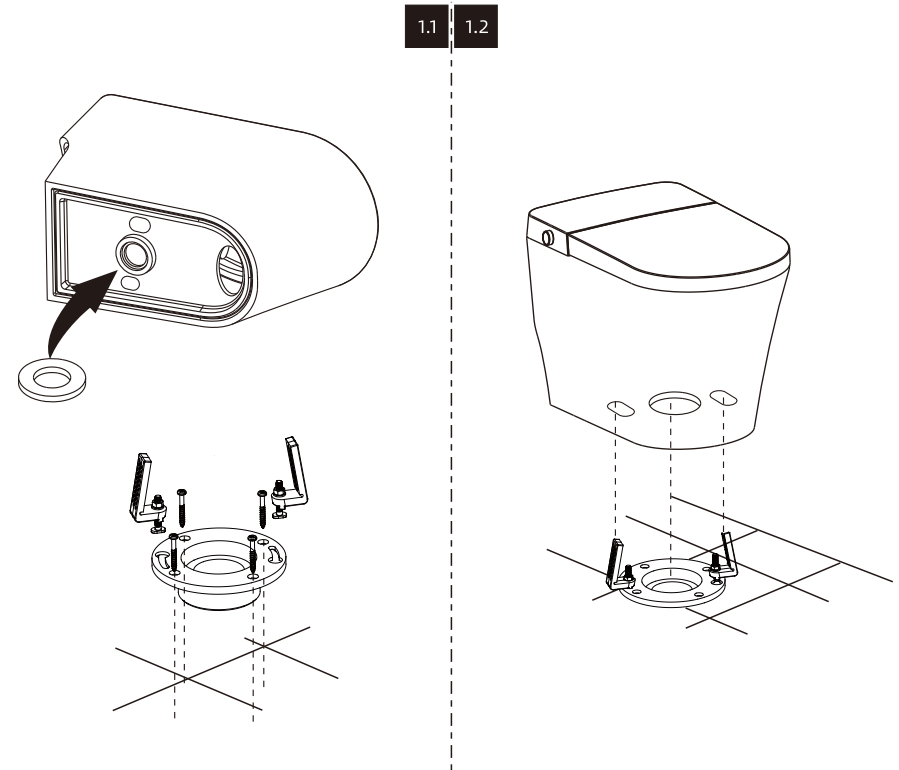

(2.1) Insert the screw through the T-shaped pad and into the mounting bracket (L-shaped plastic block) through the holes on both sides of the toilet base. Tighten securely using a tool.

(2.2) Attach the decorative cap onto the T-shaped pad to cover the screw.

(2.3) Connect the water inlet hose and the water pump to the water tank, and tighten all fittings using an adjustable wrench.

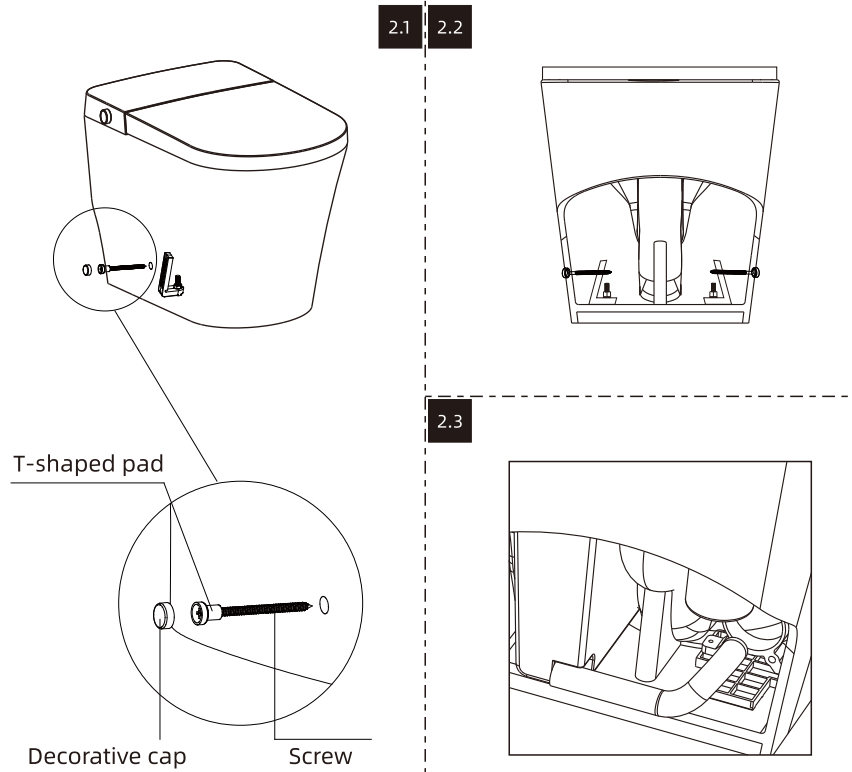

(3) Apply silicone sealant around the base of the toilet. This helps to prevent water from seeping underneath and improves overall stability.

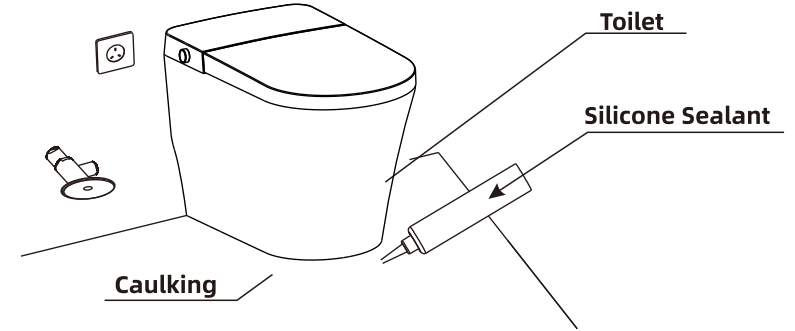

#### 4. Connect the Water Inlet Hose

Connect the inlet hose to the shut-off valve and T-valve using a wrench or other suitable tool. (For shut-off valve installation, refer to Page 3.)

**Notice:** After installation, open the shut-off valve and check for leaks.

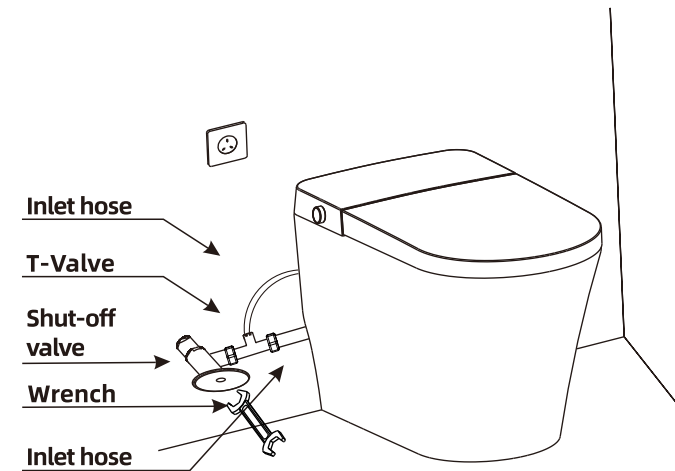

## ■ Installation of the Remote Control

### 1. Check the installation of remote control batteries.

Open the battery cover of the remote control and put two alkaline batteries (AAA) into the remote control one by one.

- Make sure to insert the batteries with the correct polarity (+/-).
- Do not mix old and new batteries or different battery types.
- Remove the batteries if the remote control will not be used for an extended period.

### 2. Confirm the installation location of the remote control.

Install the remote control in a convenient location where it is easy to reach and operate while sitting on the smart toilet.

### 3. Install the remote control bracket on the wall.

Peel off the protective film from the 3M adhesive on the back of the bracket, then press it firmly onto a clean, dry tile surface.

### 4. Install remote control.

Align the remote control with the bracket and slide it in from top to bottom. Installation is now complete.

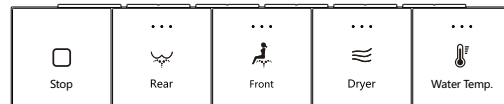

## Preparation before Use

### 1. Open the inlet valve.

Turn the valve switch counterclockwise to fully open the water inlet valve.

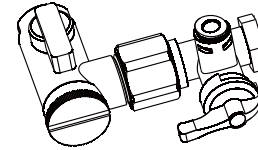

### 2. Plug the power plug into the outlet.

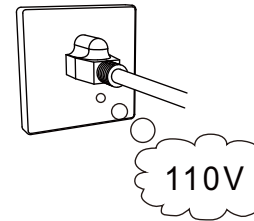

Plug the power cord into a 120V outlet. The smart toilet will perform an initial self-check, then enter standby mode.

- ◆ During the self-check, the toilet will automatically open and close the lid and seat, and reset itself. Do not attempt to block or interfere with this process.
- ◆ Do not use extension cords or any wiring that exceeds the recommended power supply specifications.
- ◆ Ensure the power outlet is properly and safely grounded.

### 3. Adjust the water temperature and seat temperature to your desired level.

### 4. Pressing the buttons on remote control to run each function refer to the function adjustment instructions.

## Panel Cognition

This product is primarily operated using the remote control, with additional functions accessible via the main control panel.

### ◆ Remote control panel

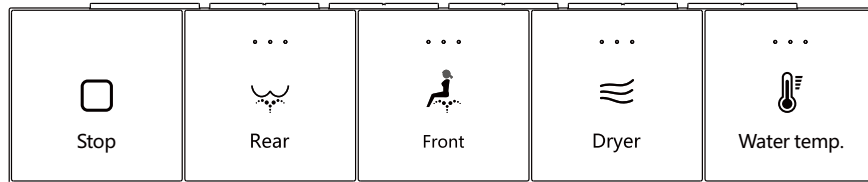

Front

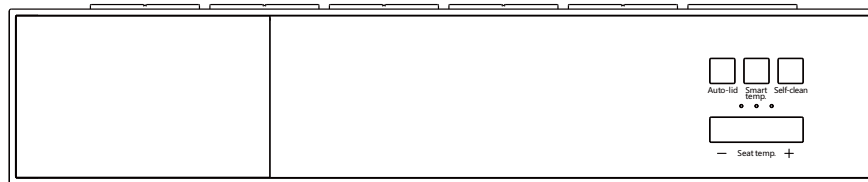

Back

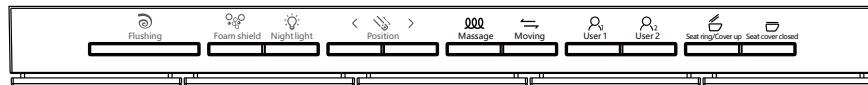

Side

### ● Remote Control Pairing Instructions:

1. While powering on the unit, press and hold both the “Front” and “Dryer” buttons on the remote control. The indicator light will start flashing, indicating that pairing mode is active.
2. Unplug the power cord and plug it back in. The knob indicator light will flash twice. Then, press the “Stop” button on the remote control. The blue indicator light on the knob will turn on, indicating successful pairing.
3. The indicator light will return to its normal state, confirming a successful pairing. Please wait for the system to complete its reset.

### ◆ Knob button(with halo)

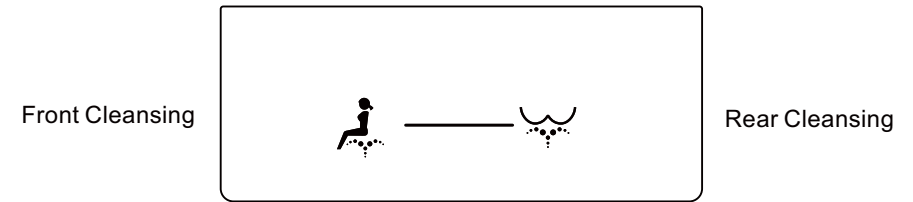



Press the knob to switch the function of flushing and stop

- Press the knob vertically to flush once when the smart toilet is not in use.
- While seated, rotate the knob clockwise to activate the rear cleansing function, or counterclockwise to activate the front cleansing function. Press the knob vertically to stop any active function, such as cleansing or drying.
- During rear or front cleansing, rotate the knob once more in the same direction to activate the drying function.

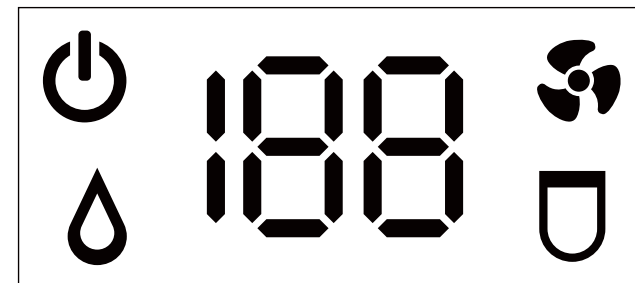
### ◆ Host display screen



 **Power Indicator:** Lights up when the smart toilet is powered on.

 **Temperature Display:** Shows the set temperature when the smart toilet is on.

 **Air Temperature Icon:** When this icon is lit, it indicates the set air drying temperature.

 **Seat Temperature Icon:** When this icon is lit, it indicates the set seat temperature.

 **Water Temperature Icon:** When this icon is lit, it indicates the set water temperature.

● The temperature display will cycle between water temperature, seat temperature, and air temperature at 30-second intervals.

● When the user leaves the toilet sensor area, the screen will automatically turn off after about 30 seconds.

## ◆ Ambient light

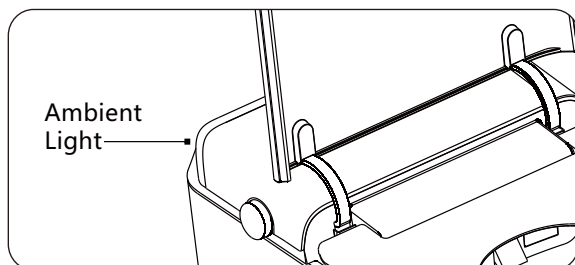

● Default Mode 1: The ambient light will automatically turn on when the toilet lid is opened, and turn off when the lid is closed and remains shut for more than 30 seconds.

● Press and hold the Night Light button on the remote control to turn the ambient light on/off or enter light mode setting.

● While the ambient light is on, press the Rear or Front wash button within 5 seconds to switch between different ambient light modes. The screen will display numbers from 1 to 64, indicating the current mode. Press the Stop button on the remote control to confirm and exit the mode setting.

## How to Use

### ■ When Seated on the Toilet Seat

- ◆ When you hear a “di” sound, all standby functions will activate.
- ◆ The cleaning nozzle will automatically clean itself once.

### ■ To Start Rear or Front Cleansing

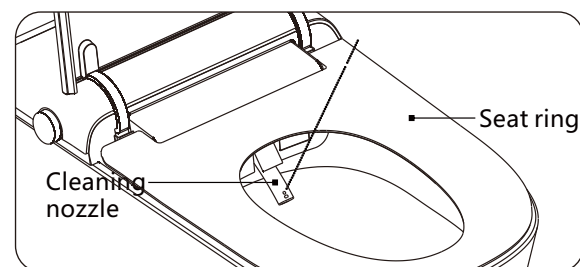

- ◆ Use the remote control to start rear or front cleansing.
- ◆ Adjust the nozzle position and water pressure using the remote control.
- ◆ Use the remote control to start the drying function.
- ◆ Press the “Stop” button to stop cleansing or drying at any time.

### ■ When Unseated from the Toilet Seat

- ◆ The toilet will automatically flush once.

## Function Setup and Adjustment

### ■ Auto-Open the Seat Cover

When you approach the toilet, the lid will automatically open. You can use the remote control to turn this function on or off.



### ■ Lid and Seat Opening

This product supports automatic and manual lid/seat opening. The lid and seat will open automatically when a person approaches or when triggered by foot sensing.

#### Using the Remote Control:

When the toilet is not in use, you can open the lid and seat using the remote control. Simply press the “Seat Ring / Cover Up” button to automatically lift both the lid and the seat. To close them, press the “Seat Cover Closed” button. This will close both the lid and seat, and the toilet will automatically flush once.

**Note:** If the last action performed was a flush, the toilet will not flush again when closing the lid and seat.

#### Using Foot Sensor:

While not seated: If the lid and seat are down, place your foot near the foot sensor once to open the seat lid only. If the lid is already open, placing your foot near the sensor again will open the seat. If both the lid and seat are already up, placing your foot near the sensor once more will close both, and the toilet will flush.

**Note:** If the toilet is already flushing, stepping near the sensor will not trigger a second flush.

- **Important Limitation:** When the toilet is in rear cleansing, front cleansing, flushing, or drying mode, you cannot open or close the seat cover or seat ring.

### ■ Rear cleansing

This function allows rear cleansing using a single movable nozzle.

Press the rear button  on remote control to start the cleansing process. The nozzle will move back and forth while spraying water.

To switch to the fixed position mode, press the button  again. The nozzle will stop moving and stay in place for concentrated cleaning.

- The rear cleansing function will automatically stop after **90 seconds**. You can also stop the function manually by: Pressing the Stop button , or Switching directly to another function using the remote control.

- The nozzle will automatically self-clean before and after the rear cleansing process.

### ■ Front cleansing

This function uses a feminine nozzle for gentle front cleansing.

Press the Front button  on the remote control to activate it. The nozzle will move back and forth for thorough cleaning.

- While front cleansing is active, press the button  again to switch to fixed position mode—the nozzle will stop moving and remain stationary. You can toggle between modes.

- The function will automatically stop after **90 seconds**, or you can manually stop it by pressing the Stop button  or switching to another function.

- The nozzle will also self-clean before and after front cleansing.

### ■ Water Pressure Adjustment

- While using **rear** or **front cleansing**, press the corresponding button again on the remote control to cycle through **4 available water pressure levels**.

### ■ Nozzle Position Adjustment

- During rear or front cleansing, press the Nozzle Position button  to move the nozzle **forward** or **backward**.

- There are 5 levels of nozzle position available. Press the Position button  repeatedly to adjust for optimal comfort and cleaning.

### ■ Water Temperature Adjustment

- Press the Water Temp button  on the remote control. The toilet will beep (“di”) and enter water temperature adjustment mode..



- Press the button  again to cycle through the available temperature levels. Stop when the desired level is reached.

- There are 4 levels of water temperature available: **Low, Medium, High, and Normal**.

## ■ Hot and Cold Massage

- Press the H/C Massage button  on the remote control to activate the hot and cold massage mode.
- The water temperature will alternate between hot and cold, switching between the normal level and your selected temperature setting.
- If the water temperature is set to normal, the massage will alternate between normal and low.

## ■ Drying Function

- Press the **Dryer** button  on the remote control to begin drying. It will help dry body parts after cleansing.
- The function will automatically turn off after **3 minutes**, or you can manually stop it by: Pressing the **Stop** button , or Switching to another function within 3 minutes.

## ■ Drying Temperature Adjustment

- Press the **Dry Temp** button  to enter drying temperature adjustment mode (you will hear a “di” sound).
- Cycle through **4 available levels: Low, Medium, High, and Normal**, by pressing the button again.

## ■ Seat Temperature Adjustment

- Press the Seat Temp button  to enter seat temperature adjustment mode (a “di” sound will play).
- Press again to cycle through **4 temperature levels: Low, Medium, High, and Normal**.

## ■ Night light

- This product includes a built-in **night light**, convenient for use in the dark.
- Press the Night Light button  on the remote control to **turn the night light on or off**.

## ■ Nozzle cleaning

Press the Nozzle Clean button  on the remote control to flush water through the nozzle for cleaning.

- This function is only available when not seated.
- The cleaning process will automatically stop after 90 seconds, or you can press the button  again to stop it manually.

## ■ Power button

Press and hold the Power button  on the remote control to shut down the host system.

## ■ Flushing via remote control

Pressing the button  on the remote control to flush the toilet once.

- If the toilet is currently cleansing, cleansing will stop immediately when flushing is activated.

## ■ Manual Flushing

Press the rotary knob vertically to flush the toilet manually.

- Manual flushing works even if the host system is powered off.
- If flushing is activated during cleansing, the cleansing function will stop.

## ■ Flushing by Foot Sensor

This feature is designed primarily for men to flush without bending or touching buttons.

- The smart toilet uses capacitive sensor technology. Lightly touch the ceramic sensor area with your foot—flushing will activate automatically after your foot leaves the sensor area.

## ■ Smart Power-Saving Mode

Once activated, the smart toilet enters power-saving mode.

- After the toilet is used, it will automatically return to normal mode, and the seat will reheat to the preset temperature.

- Press and hold the button  on the remote control to turn the power-saving mode on or off. The smart toilet will remember the last mode before power-off. When Smart Power-Saving Mode is turned on, the knob light blinks for **10 seconds**. When turned off, the knob light blinks **4 times**.



- In Smart Power Save mode, the seat heater powers down when you get up and resumes your set temperature when you sit back down.

### ■ Flushing When Power Is Off



If the power is off, press and hold the side rotary knob for 3 seconds to flush manually.

### ■ Smart Seat Temperature

- When connected to power, the smart toilet will enter Smart Seat Temperature Mode, which automatically adjusts the seat temperature based on room temperature.

- To exit Smart Mode: Press the Seat Temp button  on the remote control.  
To re-enable Smart Mode: Press and hold the Smart Temp button , or reconnect the power.

### ■ User 1 and User 2 Shortcut Settings

- Press and hold the User 1  or User 2  button for 3 seconds to save the current user's preferences, including: Nozzle position, water pressure, water temperature, seat temperature, and drying temperature.
- To use a saved profile, simply press the corresponding User 1 or User 2 button.

### ■ Foam Shield

- Manual Activation: Press the Foam Shield button on the remote control to manually activate foam protection. Foam will be dispensed once.
- Automatic Activation: Foam will be generated automatically when you are seated. To enable or disable automatic foam mode, press and hold the Foam Shield button for 3 seconds.
- Foam Dispensing Mode: Default: Rotating. Press Foam Shield during dispensing to toggle Rotating / Fixed.

## Cleaning and Maintenance

### ■ Power Plug Maintenance

Please clean the power plug regularly. When cleaning: Unplug it from the socket; wipe it with a dry cloth.

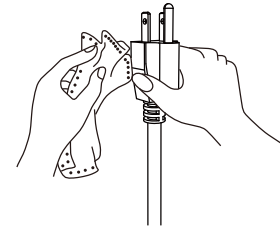

- Note: Dust buildup on the power plug may cause a fire hazard.

### ■ Cleaning the Main Body of the Smart Toilet

- To clean the surface of the main unit, use a soft, damp cloth.
- <1> Always unplug the power cord before cleaning to avoid electrical hazards.
- <2> For stubborn stains, use a soft cloth dampened with neutral kitchen detergent (non-corrosive) to gently wipe the surface.

### ■ Cleaning the Ceramic Components

- Use a neutral toilet cleaner applied to a soft brush or sponge. Rinse with tap water after scrubbing.
- <1> Do not use detergent or disinfectant contained with chlorine or acidity.
- <2> Do not use brushes with abrasive materials.

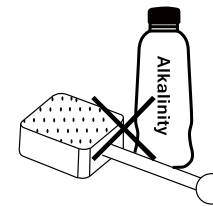

### ■ Cleaning and maintain of nozzle

In normal operating mode, press the Self-clean button on the remote control. The nozzle will automatically extend and clean itself with water. You may use a toothbrush to gently clean the nozzle during this process. Do not pull or forcefully stretch the nozzle by hand.

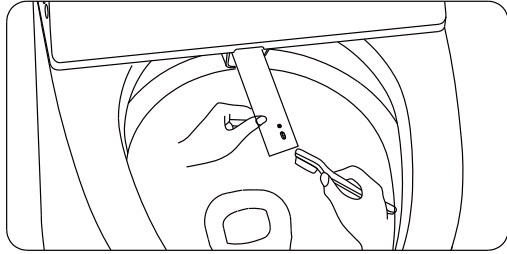

◆ Cleaning Method for Detachable Nozzle

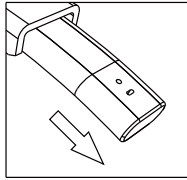

1. Press the Self-clean button on the remote control to extend the nozzle.

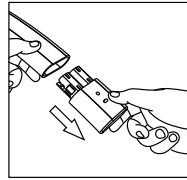

2. Once extended, gently pull out the front nozzle by hand.

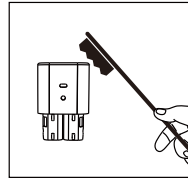

3. Use a toothbrush to clean the nozzle thoroughly.

■ Water Inlet Filter Cleaning

<1> Turn off the inlet valve to stop the water supply.

<2> Use a coin to rotate the filter cover counterclockwise to open it. Clean the filter using water or a brush.

<3> Reinstall the filter and secure it tightly. Do not forget to reinsert the seal.

<4> After reassembly, open the inlet valve and check for any leaks. If leakage is detected, disassemble, check the seal, and reinstall properly.

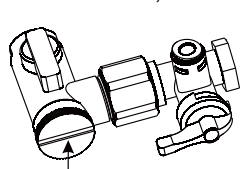

Use a coin to open the filter

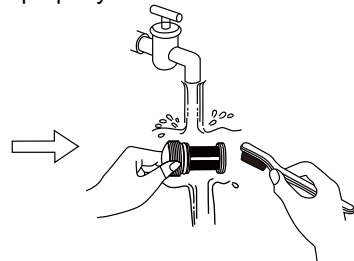

■ When Not Using the Product for a Long Time

If you do not plan to use the smart toilet for an extended period, follow these steps to prevent water contamination or freezing:

<1> Shut off the inlet valve to stop the water supply.

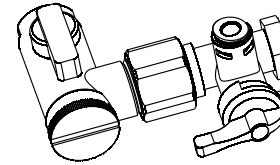

<2> Unplug the power cord from the wall outlet.

<3> Disconnect the inlet pipe from the inlet valve to drain any remaining water inside the pipe and toilet system.

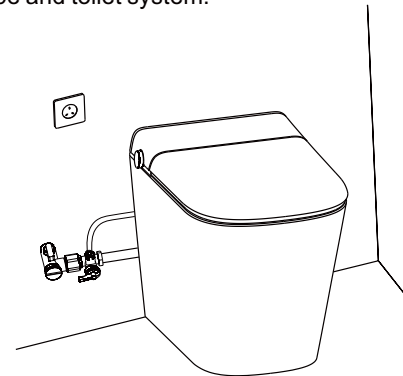

◆ When reusing the toilet, simply reconnect the inlet pipe, open the valve, and plug in the power cord to resume normal operation.

■ Frozen Protection (Winter Use)

In cold climates, the smart toilet may be damaged due to freezing. To prevent this:

- ◆ Always keep the power on during cold weather.
- ◆ Set both seat and water temperatures to the highest level to maintain warmth.
- ◆ If the inlet pipe freezes, the nozzle may not operate. In that case: Use a warm cloth to heat the pipe or valve area. Alternatively, use the built-in heating function if available.

## ■ Moisture Condensation

Due to differences in temperature and humidity between indoor air and the ceramic pan or seat cover, moisture condensation may occur.

- ◆ To reduce condensation, ensure the bathroom is well-ventilated.
- ◆ If condensation forms, wipe the affected area with a dry cloth.

## ■ Replacing Remote Control Batteries

Replace the batteries if the remote control becomes unresponsive or the indicator light does not work properly.

- ◆ Do not mix old and new batteries, or different battery types.
- ◆ Be sure to insert the batteries with the correct polarity (+/-).
- ◆ If the remote will not be used for an extended period, remove the batteries to prevent leakage.

## FAQ

Here are some common issues and how to fix them before requesting service:

Problem		Reason	Solution
The power button doesn't work (no light)		The socket power on or not?	Please check if power out or tripping operation
		Does power plug switch close or not? Are power indicator on plug off?	Press the reset button on power plug to light the indicator.
		Is it the power plug connected well?	Reconnect the power plug
Remote control is insensitive or not working		The battery run out of power	Change new battery
The temperature of seat cover, washing water and dryer are not heat enough.		Check if the setting of remote control correct or not?	Setting related temperature
		Check if it is in power-saving state?	Close the power-saving function
Button not working		Some buttons are no response on normal working state.	Some operations can not working in the same time, please read the instruction carefully.
Nozzle could not spray water or low spray water pressure	Can hear alarm	The water supply cut off?	Waiting for water supply
		Inlet valve open or not?	Open the inlet valve
		The filter blocking	Clean the filter
	Can not hear alarm	Low water pressure or you have set the low level water pressure on remote control.	Press the button to increase the water pressure
Have you hear "di" when sitting? Whether it is in the range of the sensor?		Please sit down on the seat cover and make sure you have proper posture	
Radar sensing doesn't work or doesn't work as expected.		Is the rader sensing too sensitive?	It is recommended to restart or turn off the radar sensing function. (Refer to page 20 for instructions.)

## Function List

CONFIGURATION FUNCTION	Item with Middle-level configuration	Item with High-level configuration
Ambient Light		●
H/C Massage	●	●
Rear Cleansing	●	●
Rear Cleansing with Nozzle Oscillation	●	●
Front Cleansing	●	●
Front Cleansing with Nozzle Oscillation	●	●
Cleansing Strength Adjustment	●	●
Cleansing Position Adjustment	●	●
Cleansing Water Temperature Adjustmengt	●	●
Warm Air Drayer	●	●
Seat Sensor	●	●
Seat Temperature Adjustment	●	●
Remote Control	●	●
Auto Flush When Leaving Seat	●	●
Foot Sensor Flush	●	●
Remote Control Flush	●	●
Side Knob Flush	●	●
Night Light	●	●
Nozzle Cleaning	●	●
Automatic Nozzle Cleaning	●	●
Power Outage Flush	●	●
Auto Lid Open/Close		●
Foot Sensor Lid Open		●
User 1 & 2 Preset Modes	●	●
Buit-in Tank	●	●
Foam Shield		●

● = Function included in this model; Blank = Not available in this model.

### Notes:

Features may vary depending on product model or regional version.  
Please refer to the actual product or user manual for detailed specifications.

## Product Specification

Nominal Voltage	110V~, 60Hz	
Rated Power	1300W	
Power Cord Length	1.2m	
Water Pressure Range	0.15 MPa – 0.75 Mpa (static)	
Water Efficiency Level	Level 2	
Flushing Water Consumption	< 5.0 L	
Cleaning Water Consumption	< 0.5 L/min	
Energy Consumption per Cycle	< 0.04 kWh	
Product Dimensions	L x W x H: 710 × 400 × 455 mm	
Weight of product	43kg	
Cleansing System	Water-Heating Method	Thermal type
	Water-Temp. Control	4-level adjustable, Normal level, 1st-95°F, 2nd-100°F, 3rd-104°F
	Max Heating Power	1300W
	Safety Device	Temperature sensor, temperature fuse
Seat-Heating	Heating Power	40W
	Seat Temp.	4-level adjustable, Normal level, 1st-95°F, 2nd-100°F, 3rd-104°F
	Safety Device	Temperature sensor, temperature fuse
Warm Air Dryer	Heating Power	270W
	Air Temp. Adjustment	4-level adjustable, Normal level, 1st-95°F, 2nd-113°F, 3rd-131°F
	Safety Device	Resettable thermal protector, temp. fuse

## Acceptance Record

After installation, please test the toilet and fill in the results below.

Item	Result
Is the power socket AC 110V $\pm$ 10%, and supports >2000W?	
Is the power plug secure and properly connected?	
Are any fittings loose or leaking?	
Does the toilet power on properly?	
Is there any nozzle leakage?	
Is the rear washing function working properly and adjustable?	
Is the front washing function working properly and adjustable?	
Is the wide washing function working properly and adjustable?	
Is the water temperature function working and adjustable?	
Is the seat temperature function working and adjustable?	
Is the nozzle cleaning function working correctly?	
Is the remote control functioning normally?	
Do manual and automatic flushing work as expected?	
Is the drying function working properly and adjustable?	

**Remark:**

<b>Shop:</b>	<b>Installers:</b>	<b>Inspection By:</b>	<b>Date:</b>