

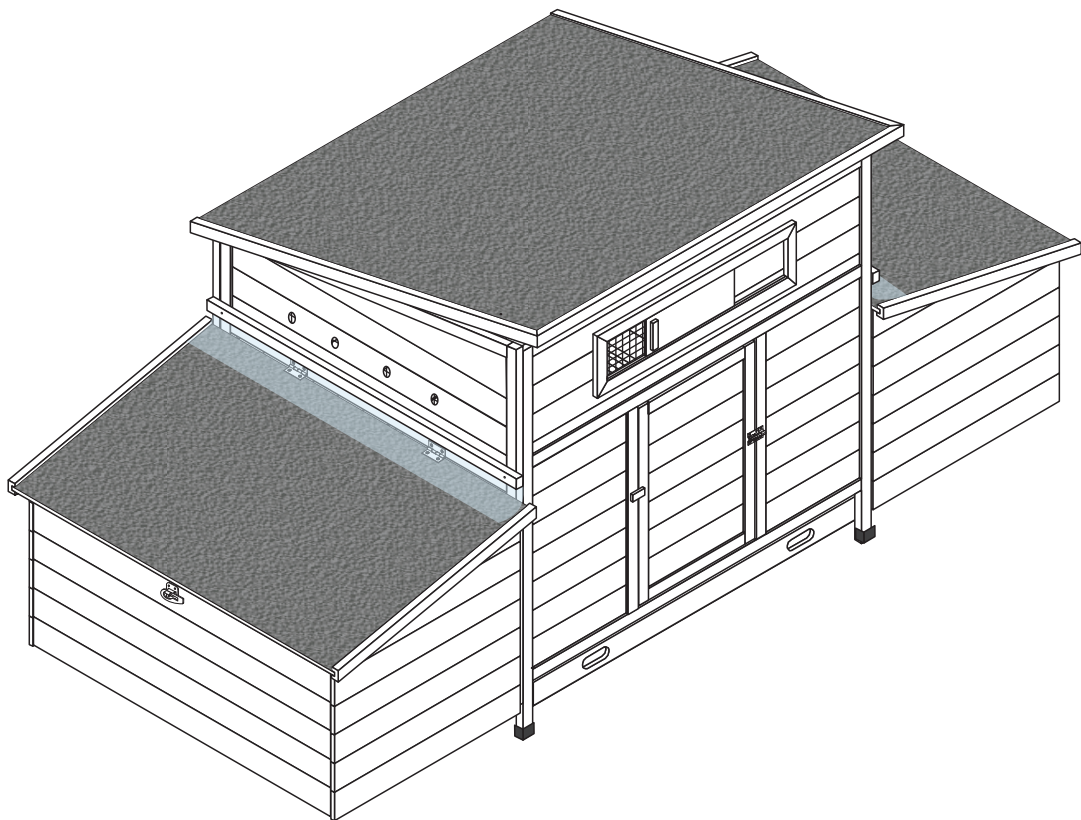

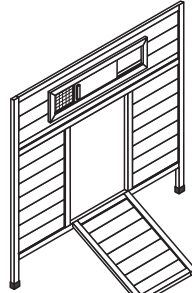

# ASSEMBLY INSTRUCTION

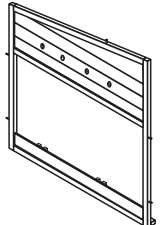
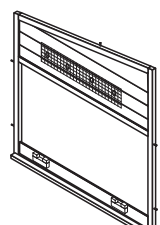
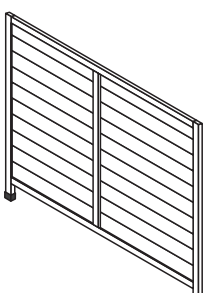
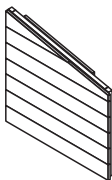
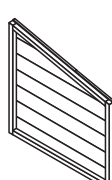
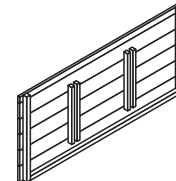
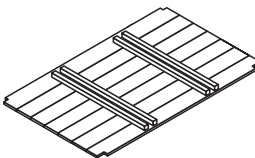

<p><b>1</b></p>  <p>1pcs</p>	<p><b>2</b></p>  <p>1pcs</p>	<p><b>3</b></p>  <p>1pcs</p>	<p><b>4</b></p>  <p>1pcs</p>
<p><b>5</b></p>  <p>2pcs</p>	<p><b>6</b></p>  <p>2pcs</p>	<p><b>7</b></p>  <p>2pcs</p>	<p><b>8</b></p>  <p>2pcs</p>
<p><b>9</b></p>  <p>4pcs</p>	<p><b>10</b></p>  <p>2pcs</p>	<p><b>11</b></p>  <p>1pcs</p>	<p><b>12</b></p>  <p>2pcs</p>
<p><b>13</b></p>  <p>1pcs</p>	<p><b>14</b></p>  <p>2pcs</p>	<p><b>A</b> M3.5*40</p>  <p>12+1 pcs</p>	<p><b>B</b> M3.5*25</p>  <p>8+1 pcs</p>
<p><b>C</b> M3*16</p>  <p>8+1 pcs</p>	<p><b>D</b> M6*50</p>  <p>8+1 pcs</p>	<p><b>E</b> M3.5*30</p>  <p>8+1 pcs</p>	

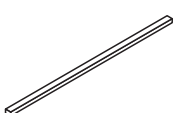
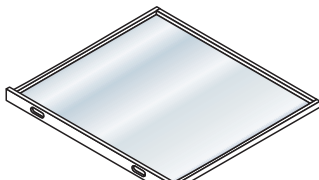
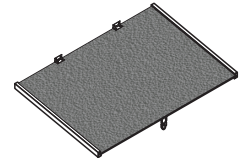
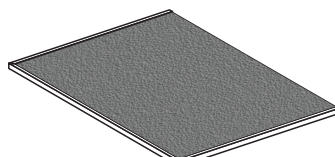
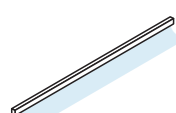
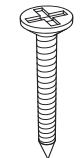
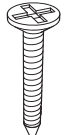

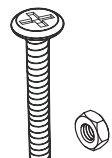
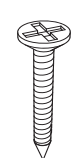
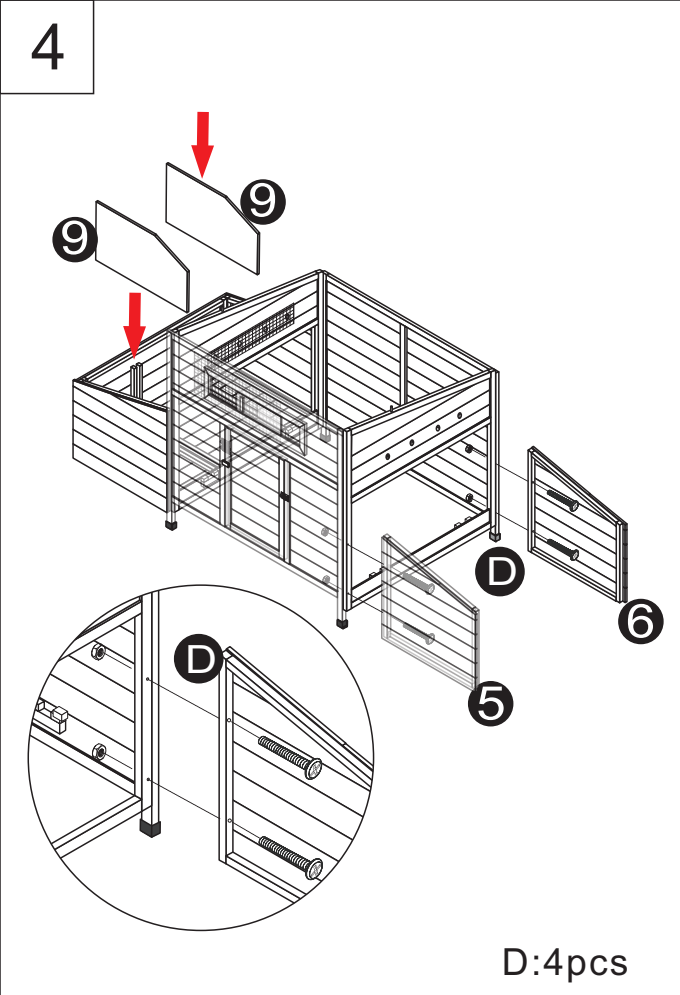
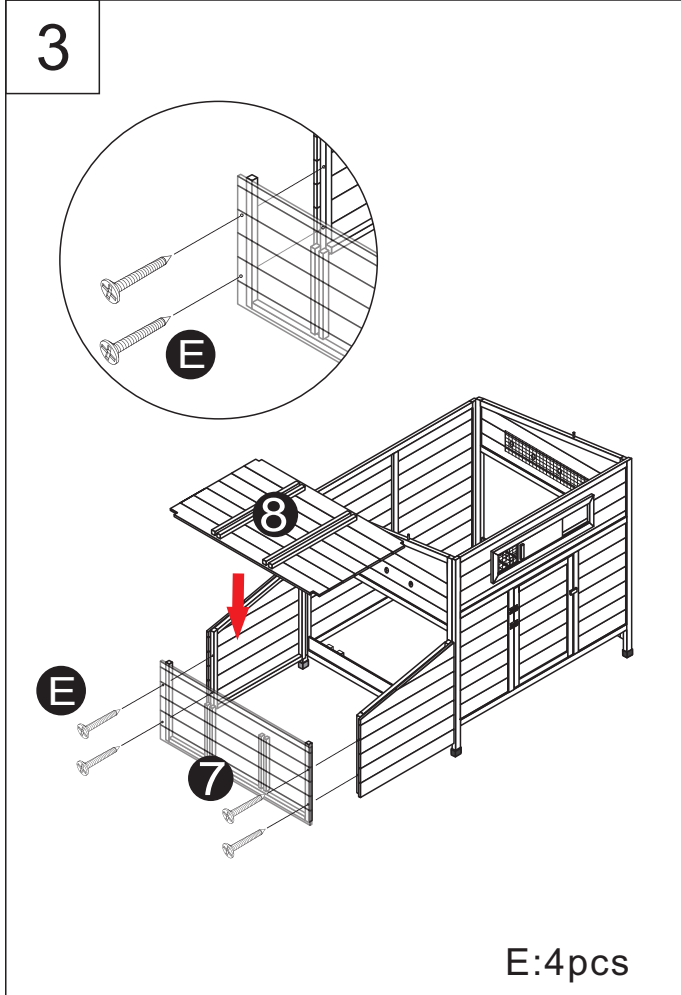
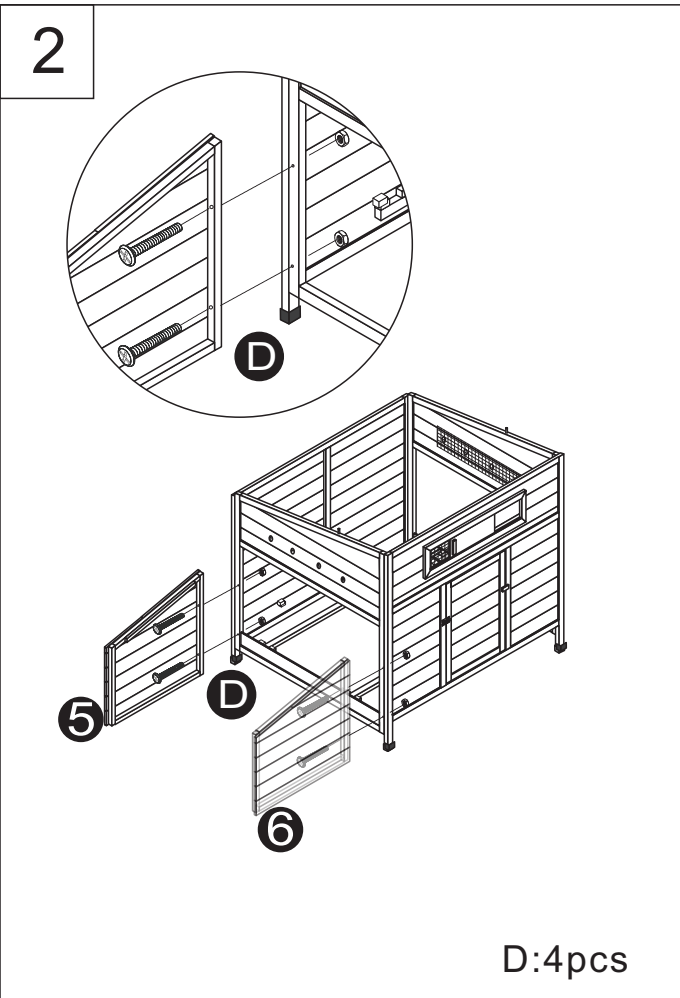
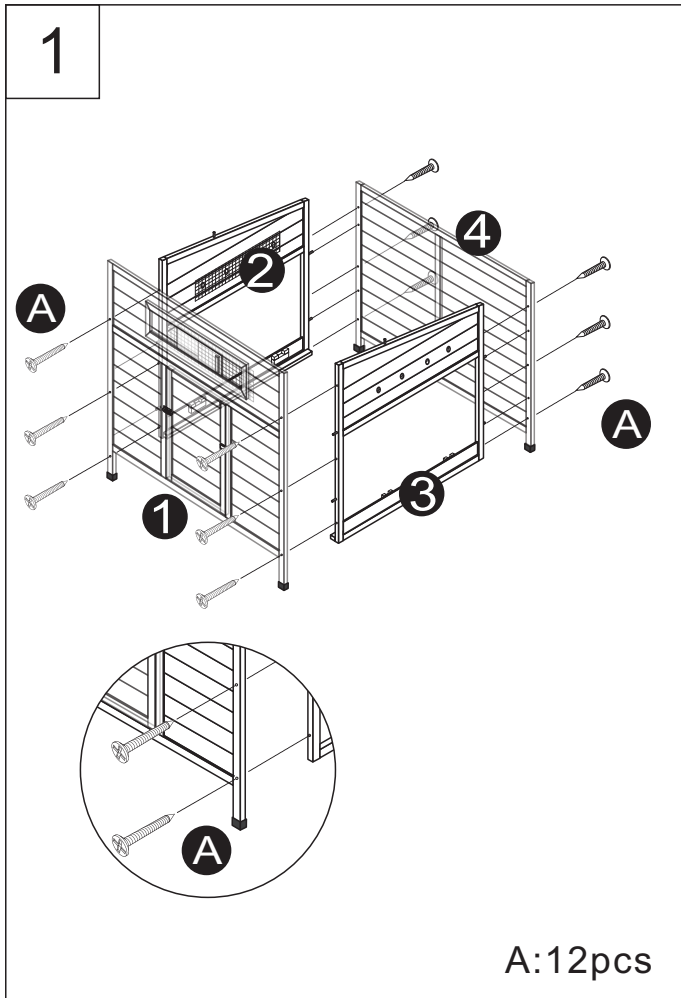
5

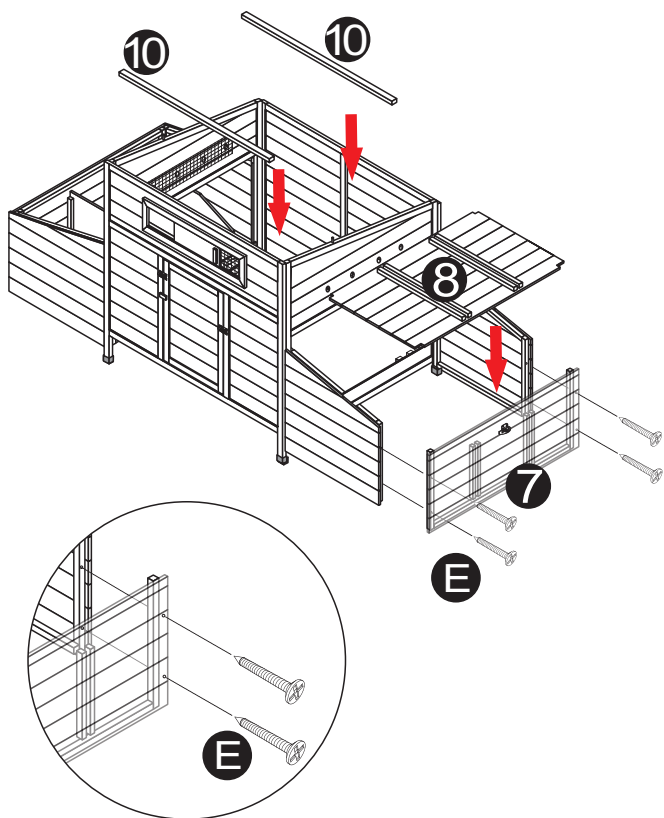

E:4pcs

6

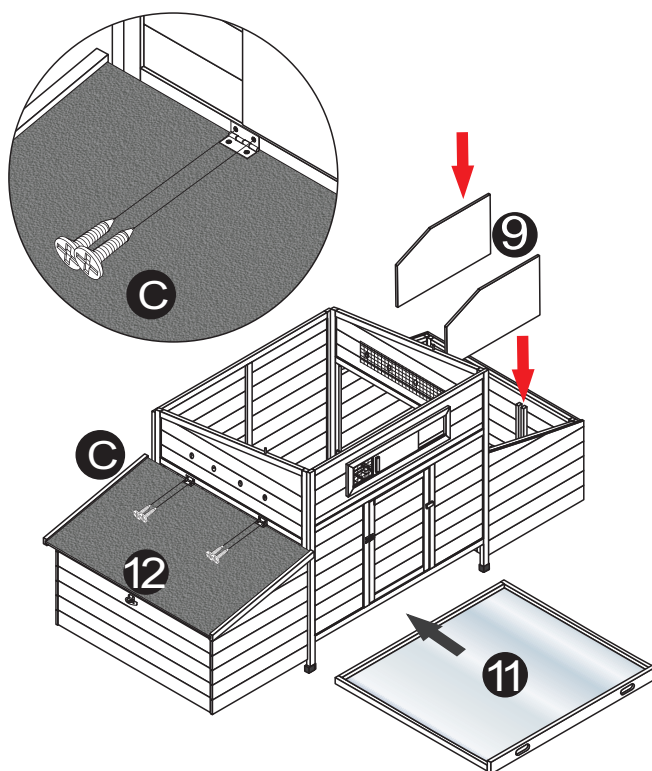

C:4pcs

7

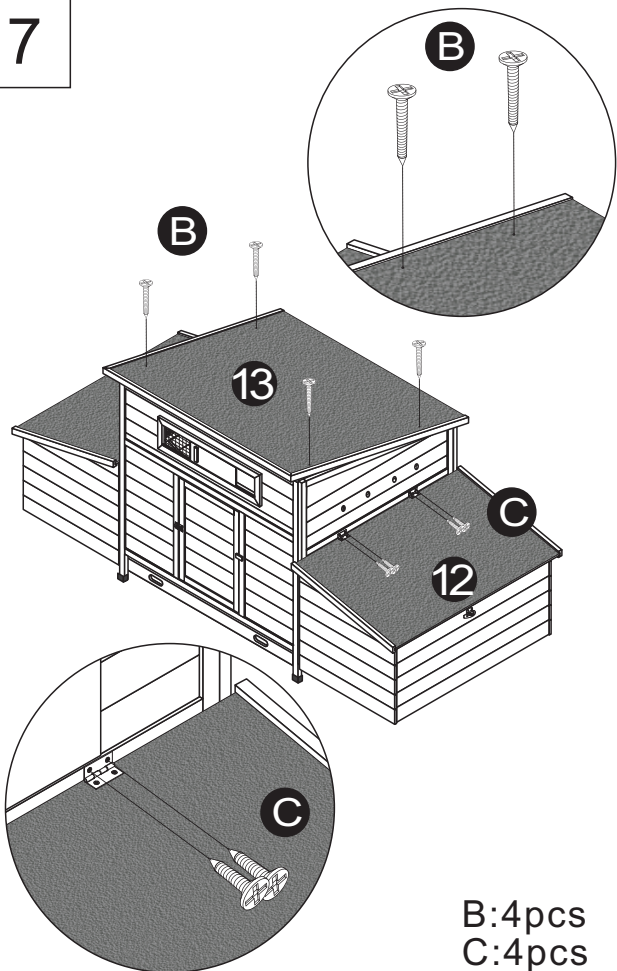

B:4pcs  
C:4pcs

8

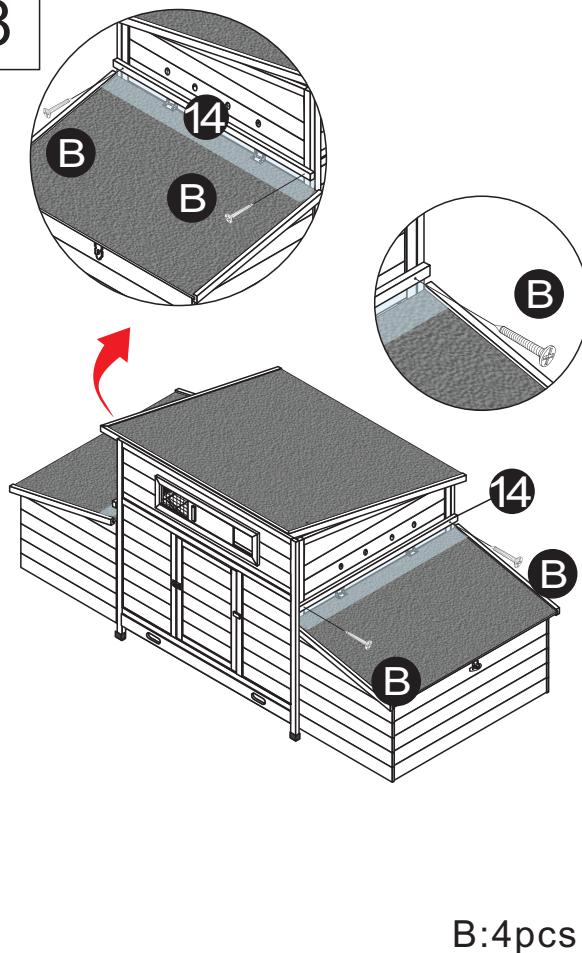

B:4pcs