

ASSEMBLY INSTRUCTIONS



Queen Bed

ASSEMBLY INSTRUCTIONS

ASSEMBLY TIPS:

1. Remove hardware from box and sort by size.
2. Please check to see that all hardware and parts are present prior to start of assembly.
3. Please follow attached instructions in the same sequence as numbered to assure fast & easy assembly.







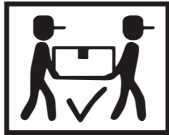







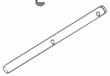



WARNING!

1. Don't attempt to repair or modify parts that are broken or defective. Please contact the store immediately
2. This product is for home use only and not intended for commercial establishments.





ASSEMBLY TIME 60 MINUTES

PARTS IDENTIFICATION

A-LSF HEADBOARD LEG		1PC	B-RSF HEADBOARD LEG		1PC
C-LSF FOOTBOARD LEG		1PC	D-RSF FOOTBOARD LEG		1PC
E-HEADBOARD		2PCS	F-RAIL 1		2PCS
G-RAIL 2		2PCS	H-SUPPORT LEG		2PCS
I-CENTER SUPPORT BAR		1PC	J-SLAT		16PCS
K-SLAT CONNECTOR		32PCS	L-FINIAL		4PCS
M-RAIL METAL JOINT		2PCS	N-HEADBOARD AND FOOTBOARD SUPPORT BAR		2PCS
O-CENTER RAIL 1		1PC	P-CENTER RAIL 2		1PC
Q-CENTER SUPPORT LEG		3PCS			

HARDWARE IDENTIFICATION

Z - HARDWARE

1	BOLT (Ø 1/4"x13MM)		34PCS	4	ALLEN WRENCH (1/4")		1PC
2	BOLT (Ø 1/4"x36MM)		10PCS	5	OPEN WRENCH (1/4")		1PC
3	BOLT (Ø 1/4")		6PCS				

ASSEMBLY INSTRUCTIONS

STEP 1

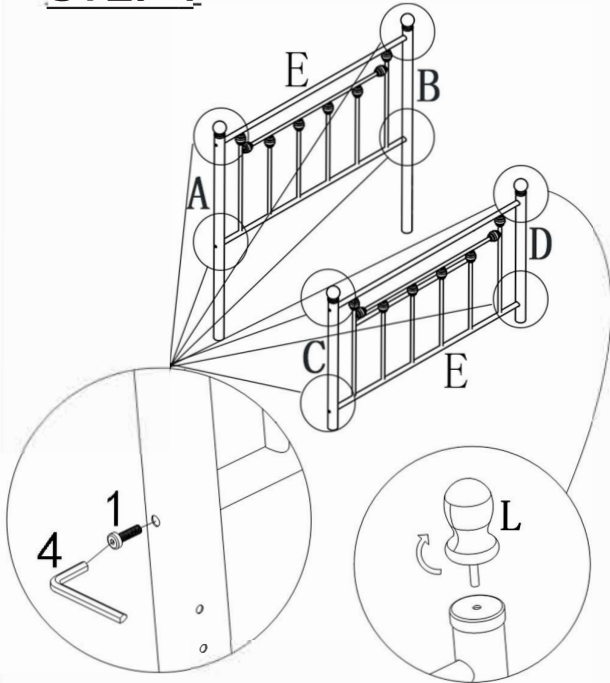

STEP 2

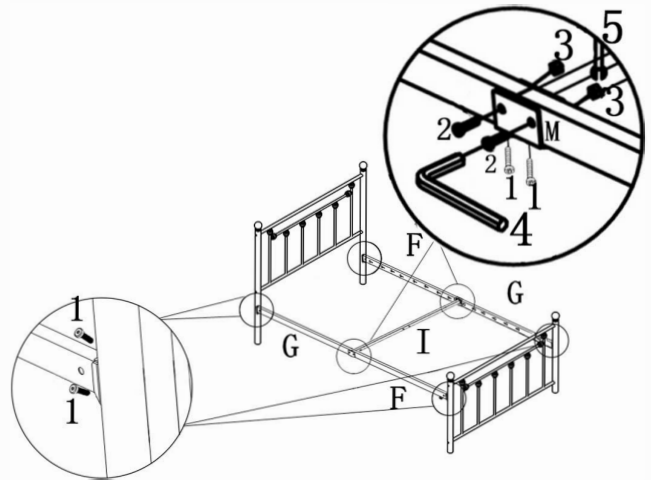

STEP 3

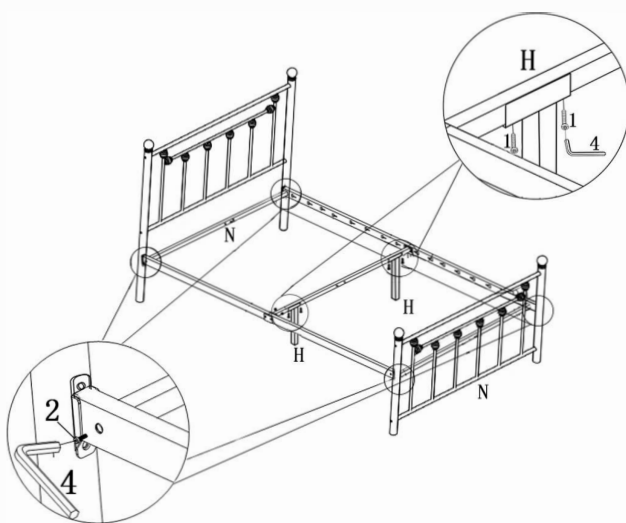

STEP 4

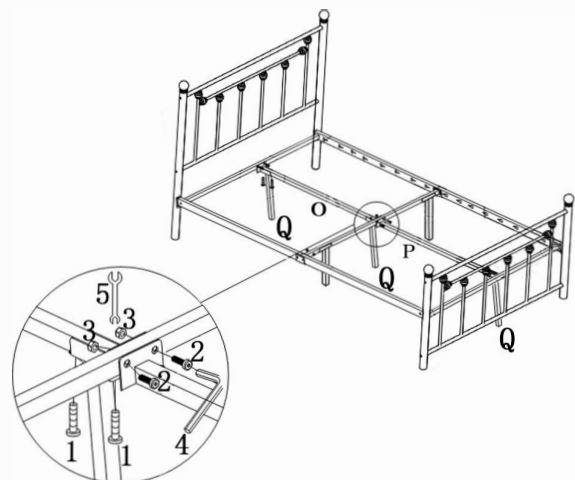

ASSEMBLY INSTRUCTIONS

STEP 5

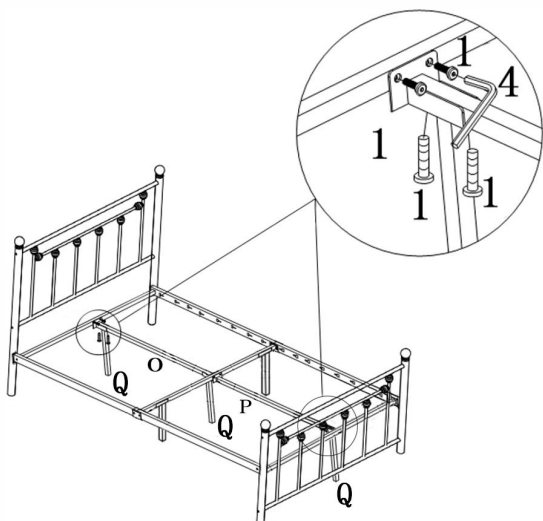

STEP 6

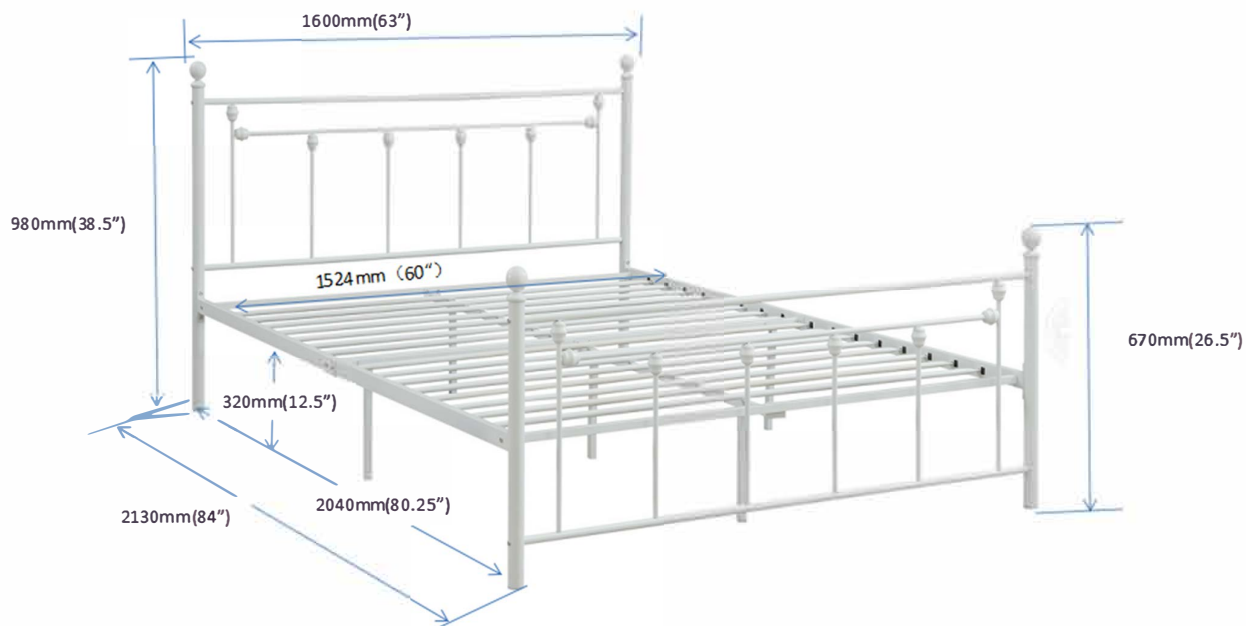
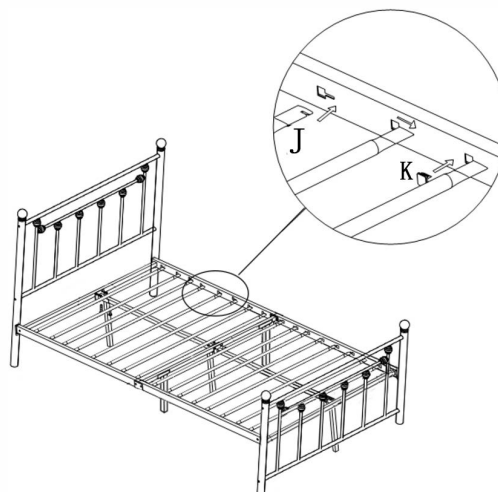

Note : Dimension tolerance $\pm 5\%$

