











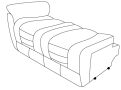

ASSEMBLY INSTRUCTIONS

SECTIONAL SOFA

Thank you for purchasing this product. Be sure to check all packing materials carefully for small parts that may have come loose inside the carton during shipment. **Before You Assemble:** Please read all instructions carefully before beginning assembly. It is recommended that 2 people work together during assembly to prevent personal injury and to ensure that heavy or cumbersome parts are not damaged during the process.

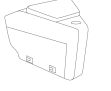
CAUTION: For your safety, this product requires two people to lift.

PARTS LIST

A	LSF LOVESEAT SEAT		1PC	G	RSF LOVESEAT WING		1PC
B	RSF LOVESEAT SEAT		1PC	H	LSF LOVESEAT BACK		2PCS
C	ARMLESS RECLINER SEAT		1PC	I	RSF LOVESEAT BACK		2PCS
D	CONSOLE BASE (CONTROL BUTTONS)		1PC	J	ARMLESS RECLINER BACK		1PC
E	CONSOLE BASE (NO BUTTONS)		1PC	K	CONSOLE BACK		2PCS
F	LSF LOVESEAT WING		1PC	L	TRANSFORMER EHF#PU8070-TRANSFORMER		3PCS

STEP 1 : ATTACH WINGS AND BACKS TO SEAT PIECES

1.1 : Connect LSF Wing to LSF Loveseat Back: line up female bracket on the wing (F) with the male bracket on the back frame(H) and slide the male bracket into the female bracket until fully secure. Repeat for the RSF Wing (G) and Loveseat Back(I).

1.2: While holding up the backrest flap, align brackets on each back with the brackets on each corresponding seat as pictured below. Lower into place, then push down firmly until fully secure.

1.3: Attach velcro of back flap by starting in the middle and working your way towards the outside, pulling the flap tight as you go.

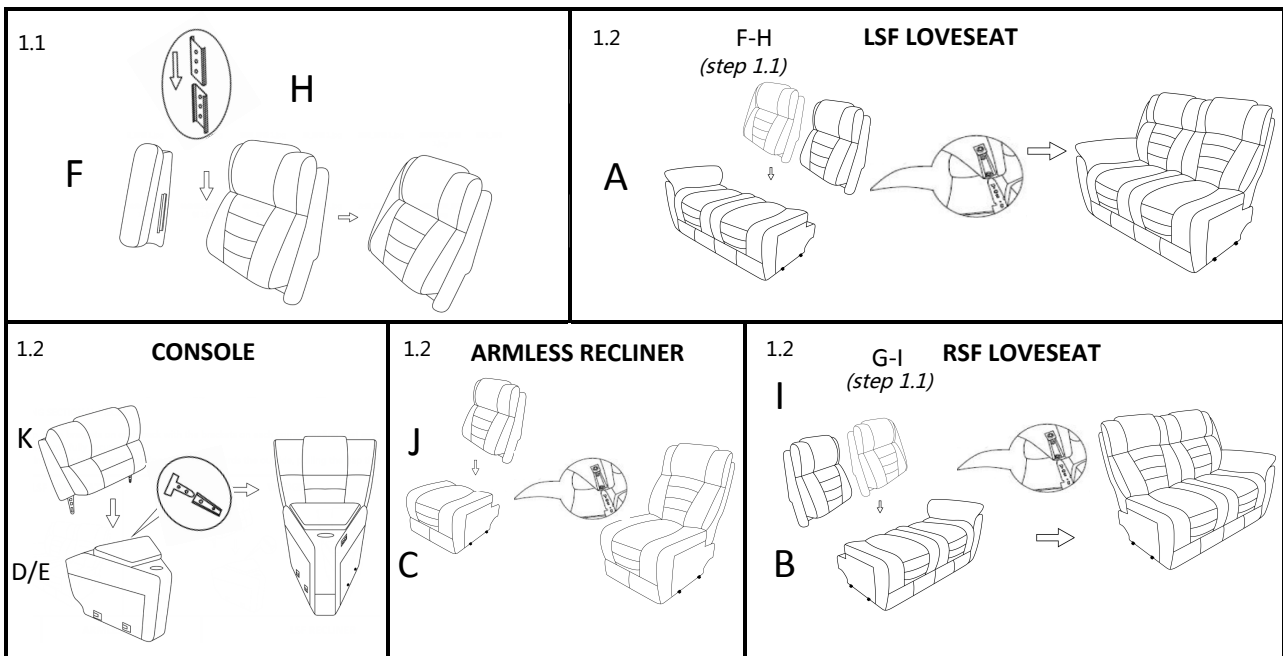

STEP 2: ASSEMBLE THE SECTIONAL

Hook the clip in the LSF Loveseat into the bracket in the base of the Console Base(Control buttons).
 Continue assembly from left to right by always hooking the clip of the left unit into the bracket of the right unit.
 Unit assembly order: LSF Loveseat, Console (Control buttons), Armless Recliner, Console (no buttons), RSF Loveseat.

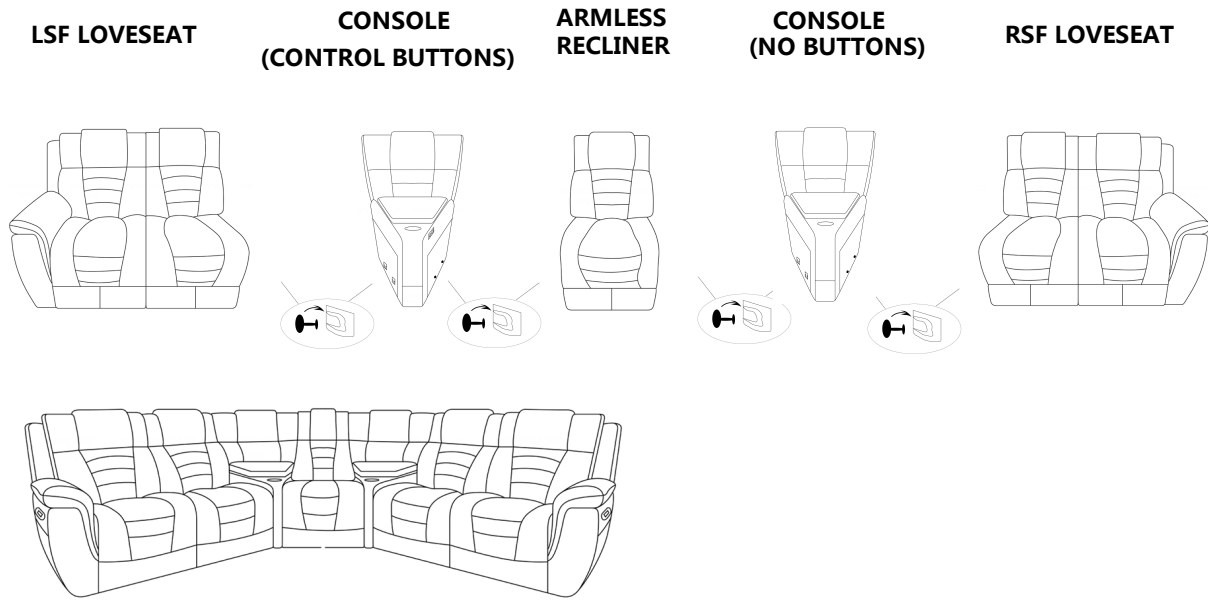

STEP 4: COMPLETE ASSEMBLY

Connect the transformers and plug into outlets

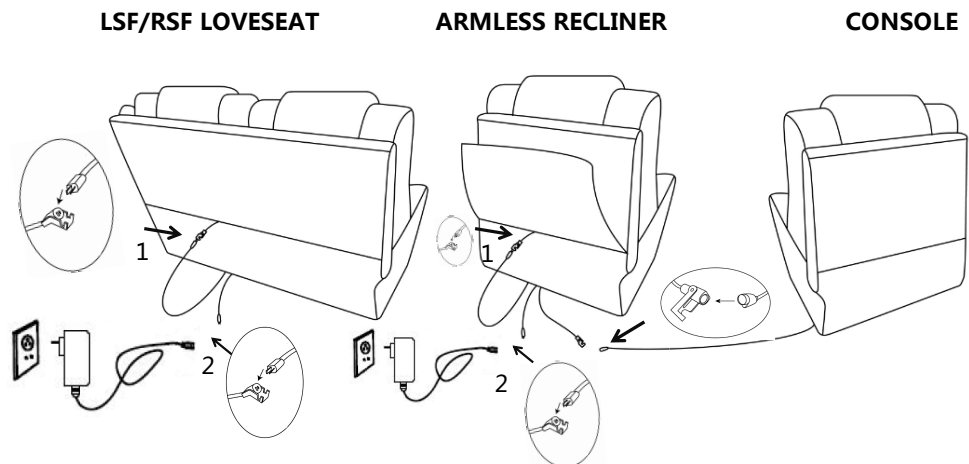

LSF/RSF LOVESEAT

1. Connect the male electrical plug from LSF/RSF loveseat back to female plug from LSF/RSF loveseat base.
2. Connect the male electrical plug from Armless Recliner base to the female plug from Transformer (L).

ARMLESS RECLINER

1. Connect the male electrical plug from Armless Recliner back to female plug from Armless Recliner base.
2. Connect the male electrical plug from Armless Recliner base to the female plug from Transformer (L)

CONSOLE

- Connect the male electrical plug from Console base to the female plug on the Armless Recliner base.

