

ASSEMBLY INSTRUCTIONS

KING FLOATING BED, LED LIGHT

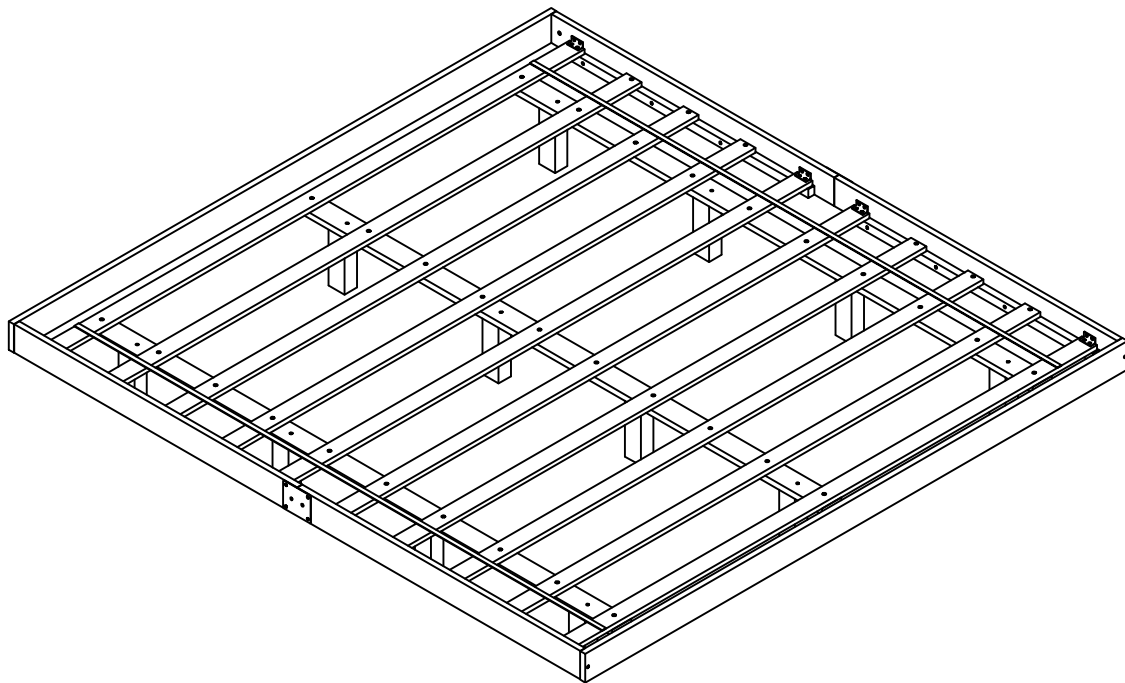



SA33797

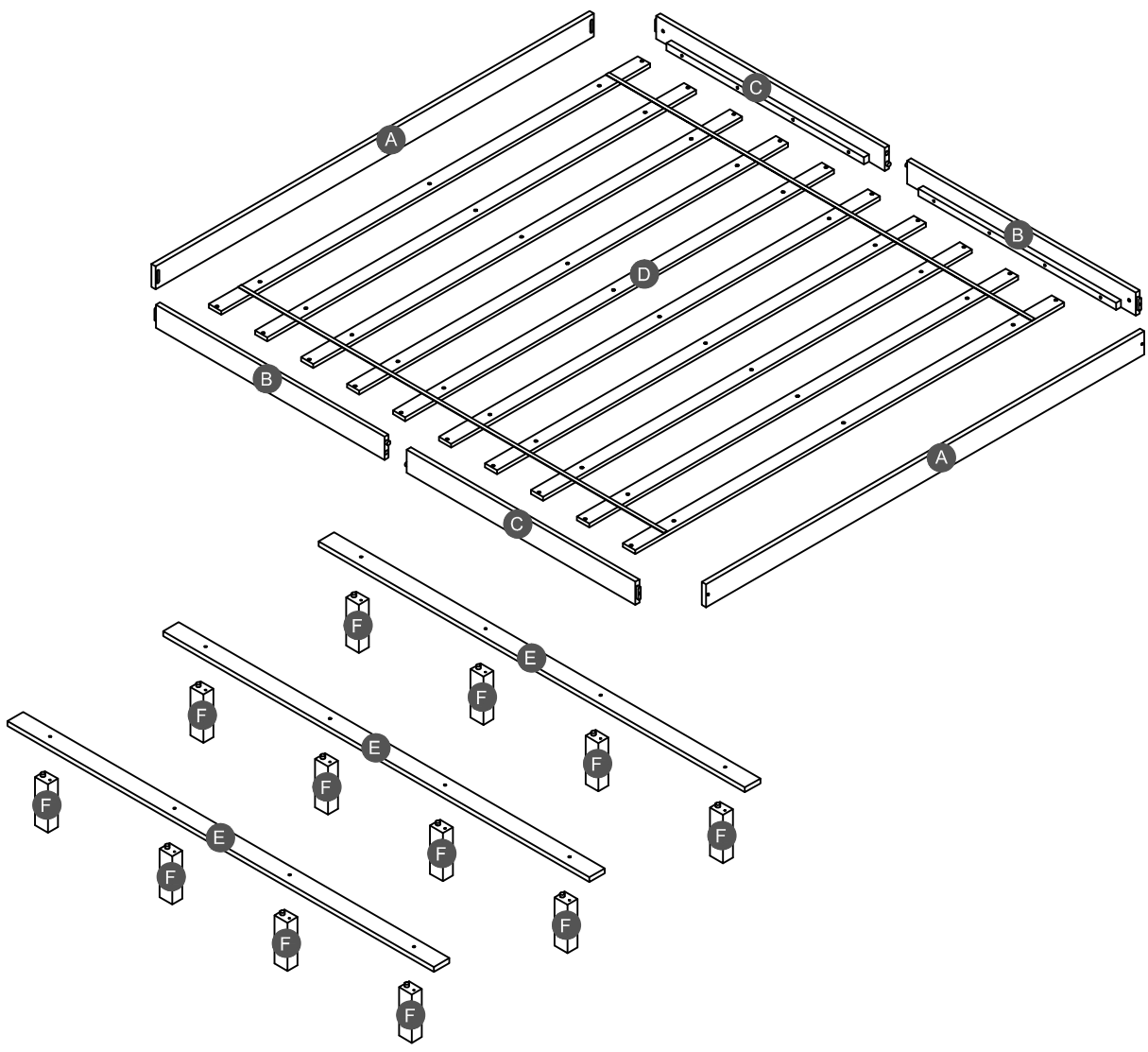



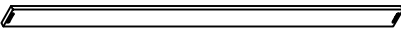
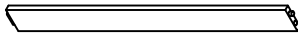
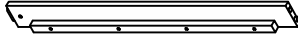
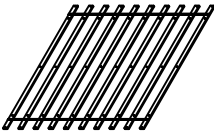





Detail View

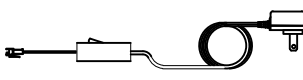
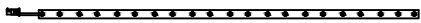

Part List

A  Horizontal bar HB/FB - 2pcs	B  Side rail (Left front/Right back) - 2pcs	C  Side rail (Right front/Left back) - 2pcs
D  Slat - 1Set = 10pcs	E  Lower support slat - 3pcs	F  Leg support - 12pcs

Hardware List

1  (Ø12)1/4"*60mm Hex-Head bolts (4pcs)	2  1/4"*15 (9.5mm) Horizontal-Hole bolts(4pcs)	3  (Ø12)1/4"*50mm Hex-Head bolts (12pcs)
4  Ø4*30mm Wood screws (50pcs)	5  (1/4")4.5*58mm Allen key (1pc)	6  Ø3.5*15mm Wood screws (49pcs)
7  40*18*18*2mm Metal bracket (8pcs)	8  L3000mm Adapter and wire strip (1pc)	9  L5000mm Led light (1pc)
10  22*10*6mm Clamp plastic (1pc)	11  18*20*20*1.5mm Metal bracket (4pcs)	12  100*80*1.5 mm Metal bracket (2pcs)

ASSEMBLY TOOLS REQUIRED (NOT INCLUDED)

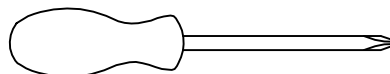

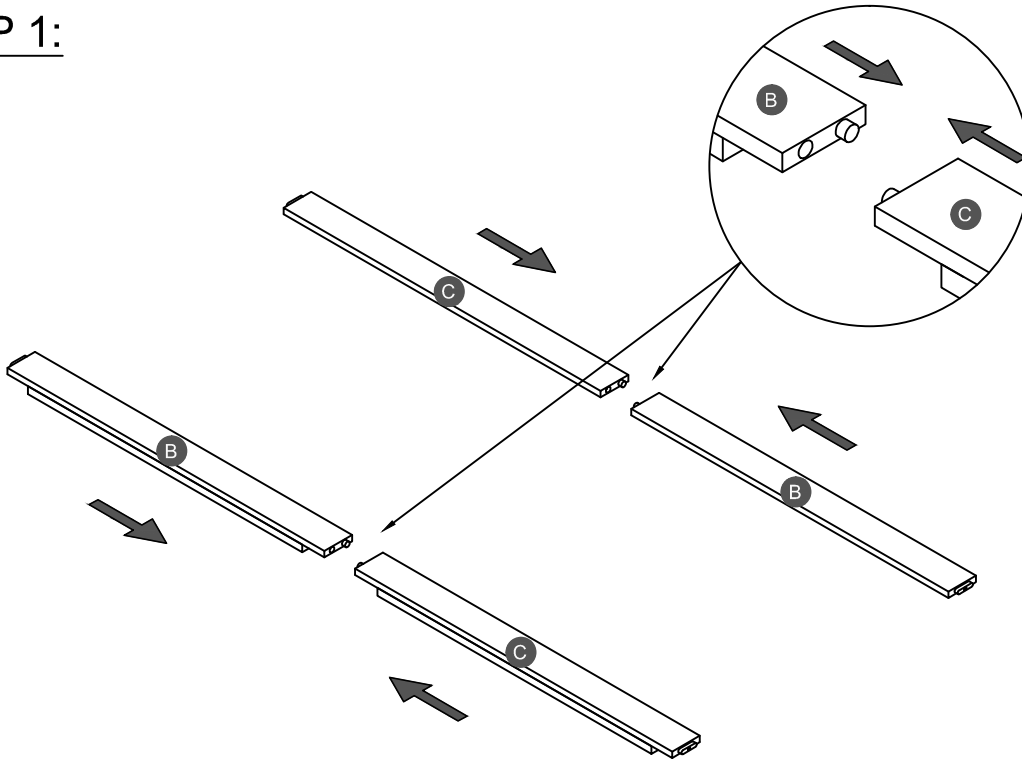

PLEASE BE CAREFUL DO NOT DAMAGE THE HOLE POSITION WHEN YOU USE POWER TOOLS !

STEP 1:

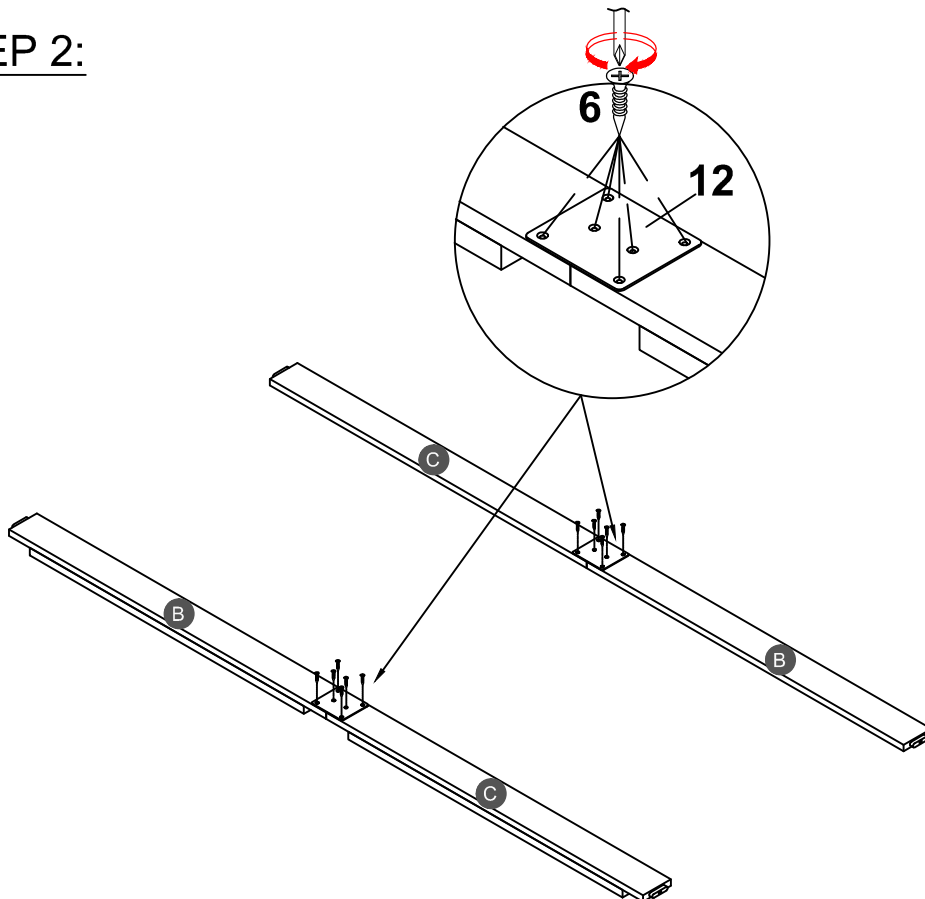

STEP 2:

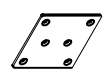

6	
	12PCS
12	
	2PCS

STEP 3:

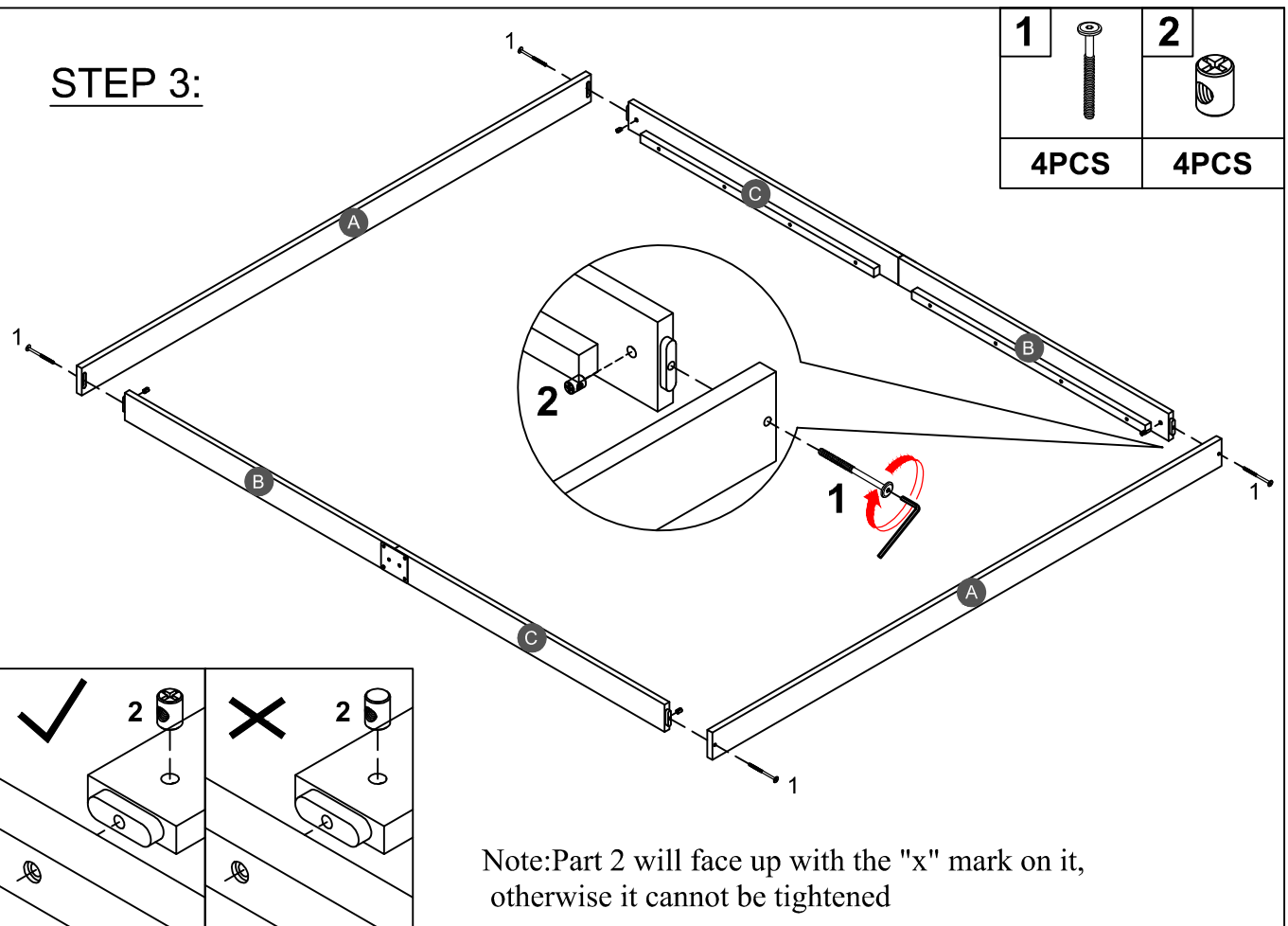

STEP 4:

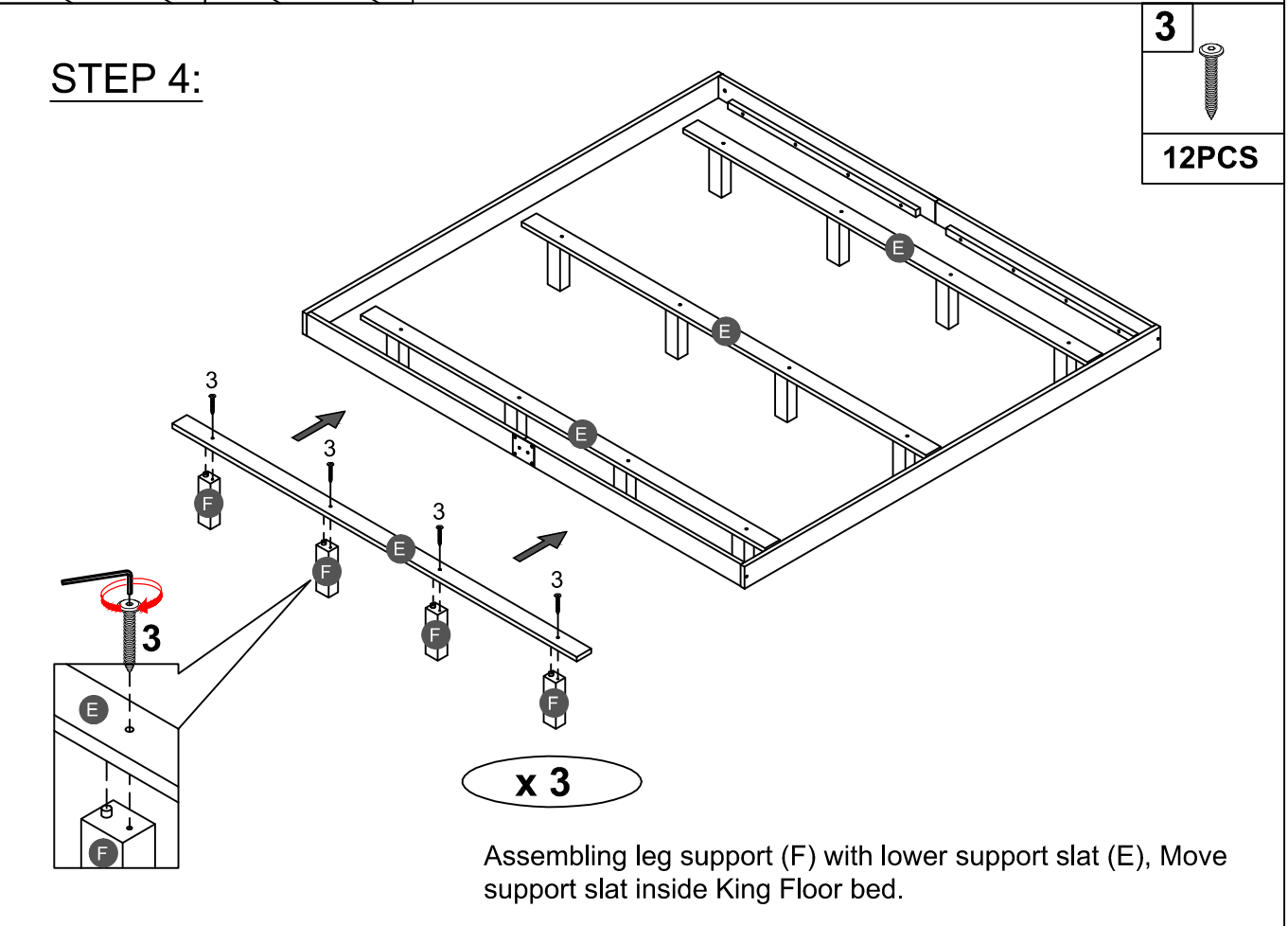

STEP 5:

4



50PCS

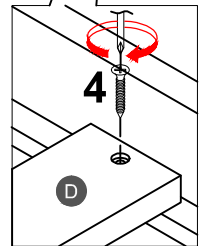
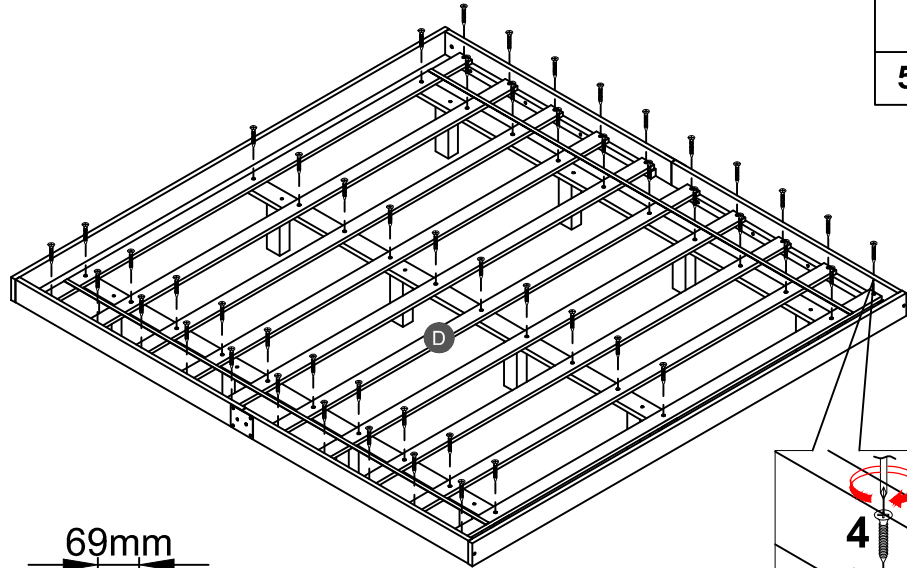

69mm

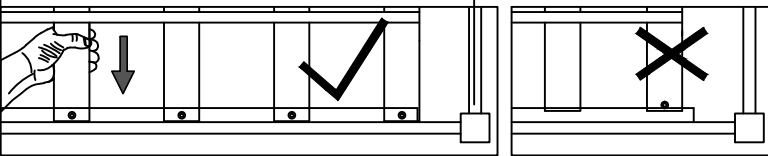

Note: Do not lock the screws of the bed slats to the outermost edge of the bed slats, you need to leave a certain space at the edges, otherwise it will cause the board to break.
Do not lock the bed slats on the edge of the wood, please hold firmly before screwing , hold it in place with one hand, then lock the screw.

STEP 6:

6



32PCS





7

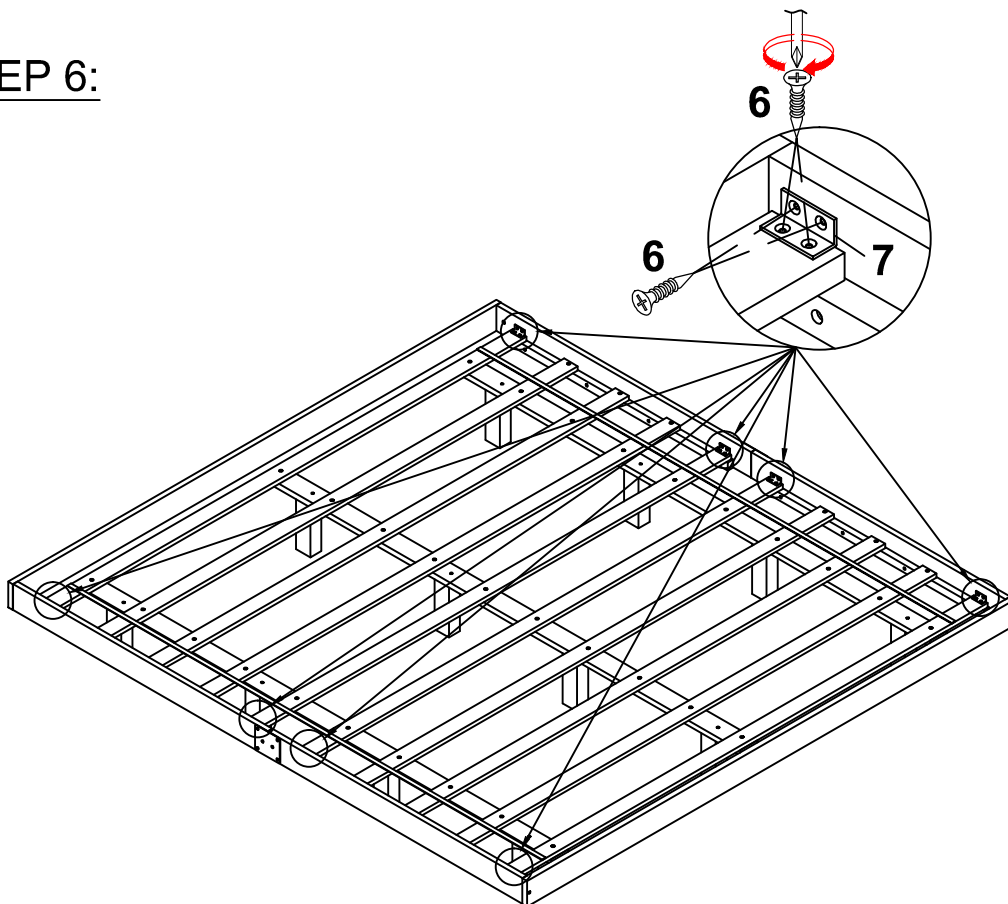

8PCS

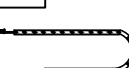

STEP 7:

6	8	9	10	11
				
5PCS	1PC	1PC	1PC	4PCS

