

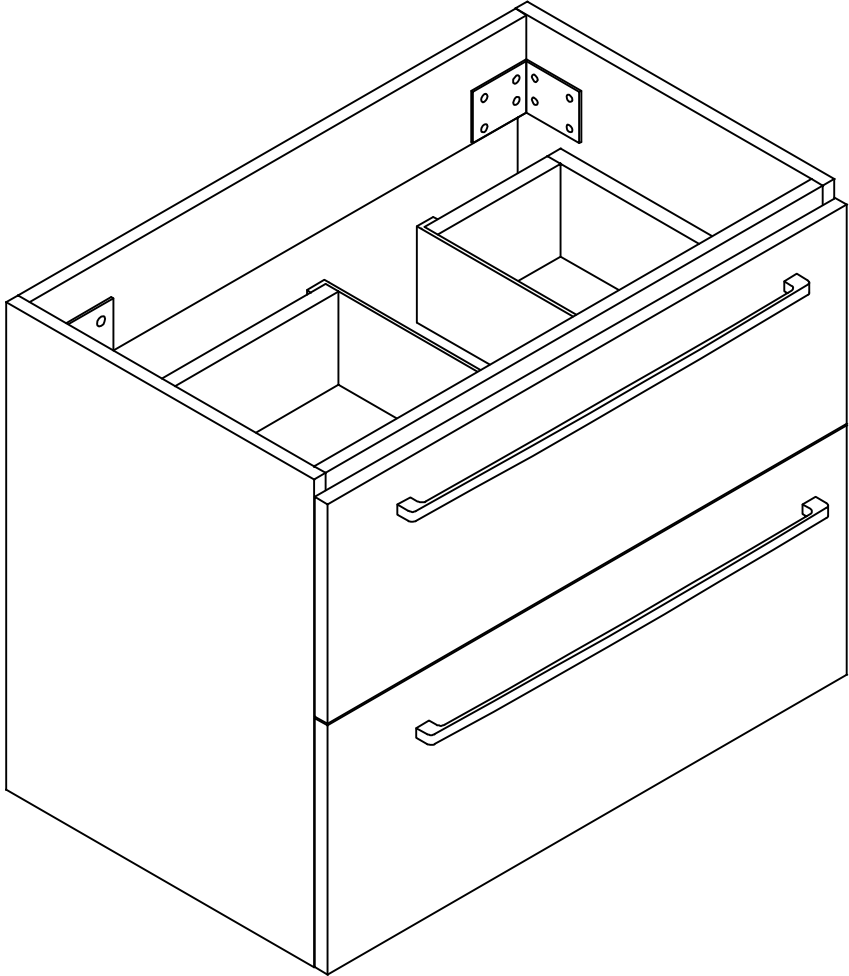

HESEBC007



DIMENSIONS





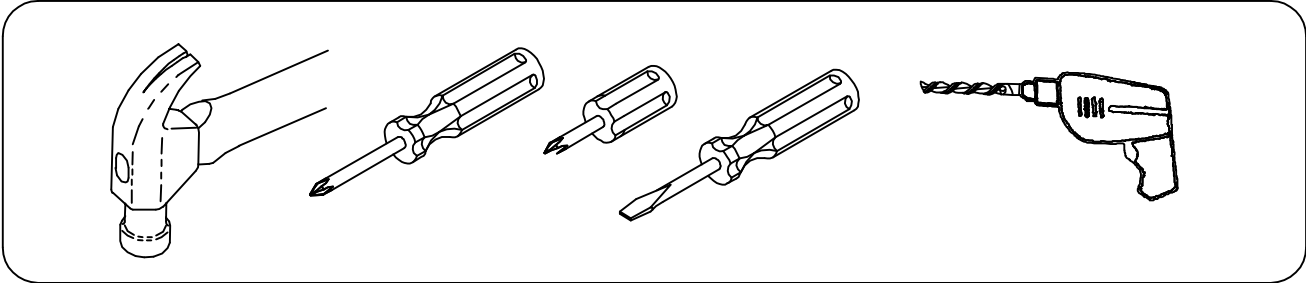



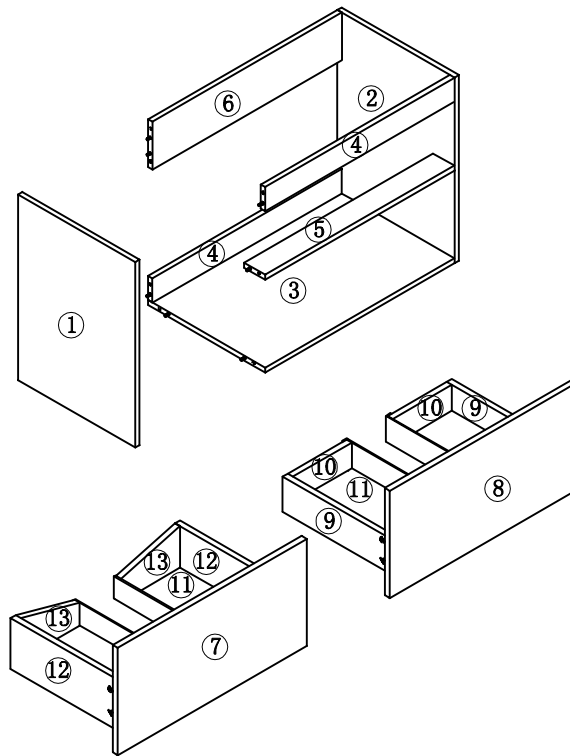





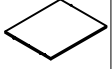

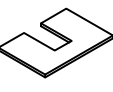







YOU MAY NEED (NOT SUPPLY)



ASSEMBLY DIAGRAM





PARTS LIST					
PARTS LIST					
NO	DESCRIPTION	QTY	NO	DESCRIPTION	QTY
①	Left side panel 	1	⑧	Upper drawer front panel 	1
②	Right side panel 	1	⑨	Upper drawer side panel 	2
③	Bottom panel 	1	⑩	Upper drawer rear panel 	2
④	Long front and rear panel 	2	⑪	Drawers bottom panel 	2
⑤	Front middle panel 	1	⑫	Lower drawer side panel 	2
⑥	Upper back panel 	1	⑬	Lower drawer rear panel 	2
⑦	Lower drawer front panel 	1			

PARTS LIST					
HARDWARE LIST					
NO	DESCRIPTION	QTY	NO	DESCRIPTION	QTY
A	Three-in-one eccentric wheel 	40	G	4*23mm screw 	4
B	Three-in-one connecting rod 	40	H	Drawer handle 	2
C	Three-in-one sticker 	40	I	White angle bracket 	2
D	8*40mm wood dowel pins 	22	J	Drawer U-shaped plastic 	2
E	Drawer slides 	4			
F	4*16mm screw 	60			
<p>CAUTION: Please confirm the parts list before installation</p>					

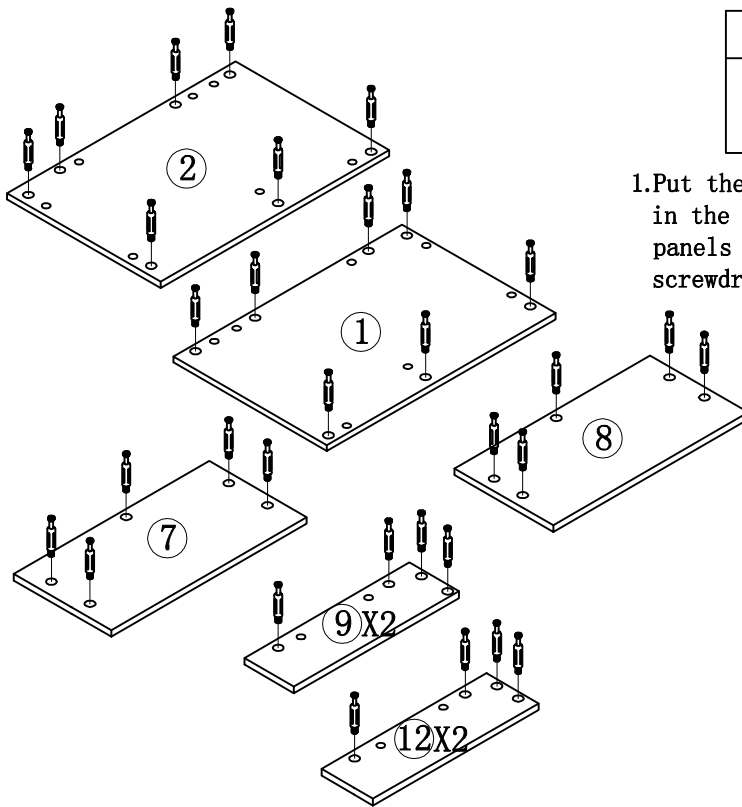
STEP 1



HARDWARE LIST	
Three-in-one connecting rod B  40PCS	

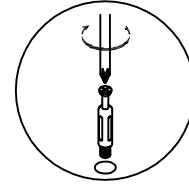

1. Put the three-in-one connecting rod in the $\phi 10\text{mm}$ hole of the following panels and tighten them with a cross screwdriver or an electric tool.

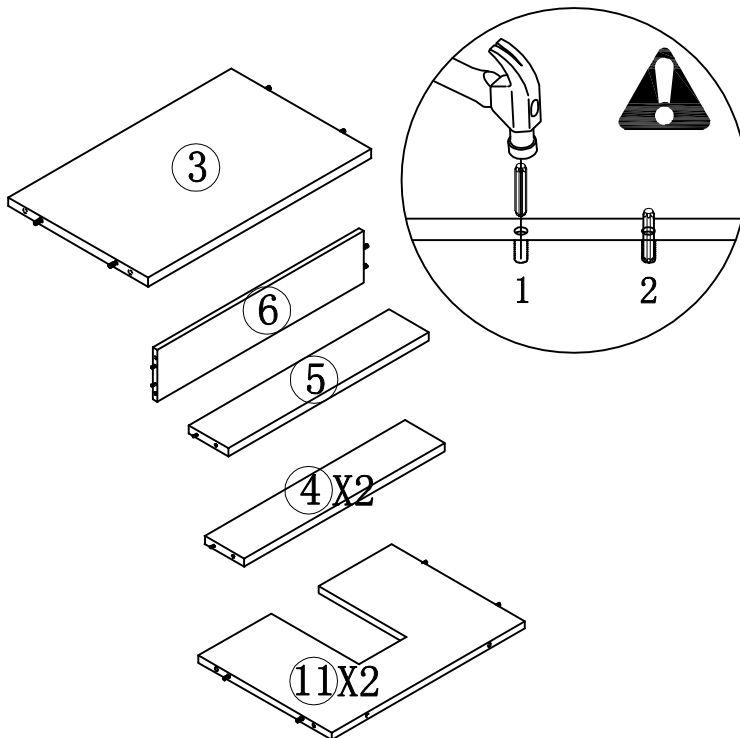

STEP 2





1. Strike the $\phi 8*40\text{mm}$ wood dowel pin into the $\phi 8\text{mm}$ hole of the above panels with an iron hammer. Please note that the hole of the three-in-one connecting rod should also be 8mm. The hole of the three-in-one connecting rod connects to the hole of $\phi 15\text{mm}$ three-in-one eccentric wheel.

HARDWARE LIST	
8*40mm wood dowel pins D  22PCS	

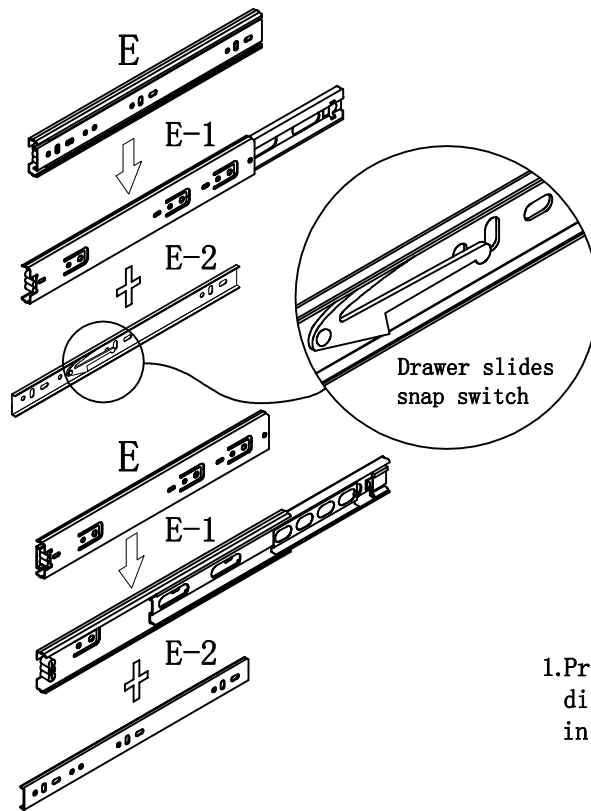
STEP 3





HARDWARE LIST	
Drawer slides	
E  4PCS	

1. Press the slide snap switch, disassemble slide blocks and put them in a place properly for further use.

STEP 4

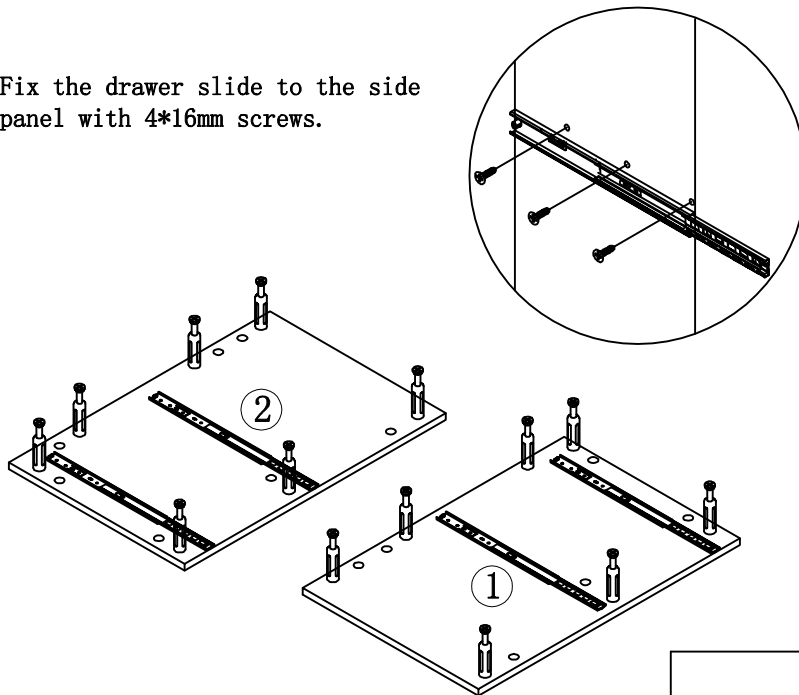
1. Fix the drawer slide to the side panel with 4*16mm screws.

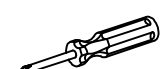

HARDWARE LIST		
4*16mm screw	Drawer slides	
F  12PCS	E-1  4PCS	

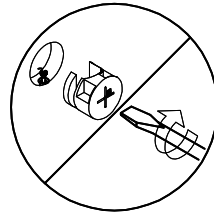
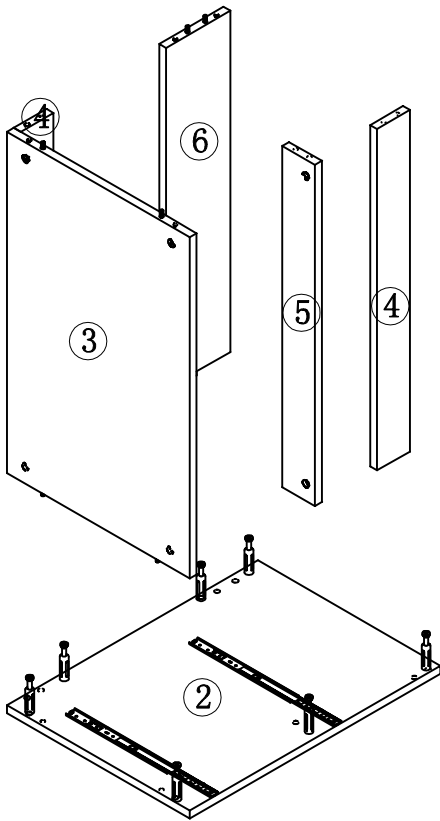

STEP 5

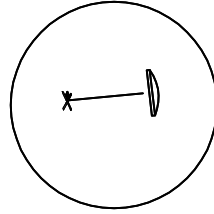

1. Connect No. 3-4-5-6 panel to No.2 panel tightly with the three-in-one eccentric wheel.



2. Cover the mounting hole of the eccentric wheel with a three-in-one sticker.

HARDWARE LIST		
Three-in-one eccentric wheel A  7PCS	Three-in-one sticker C  7PCS	

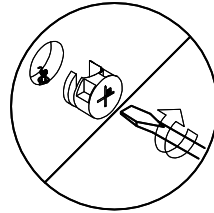
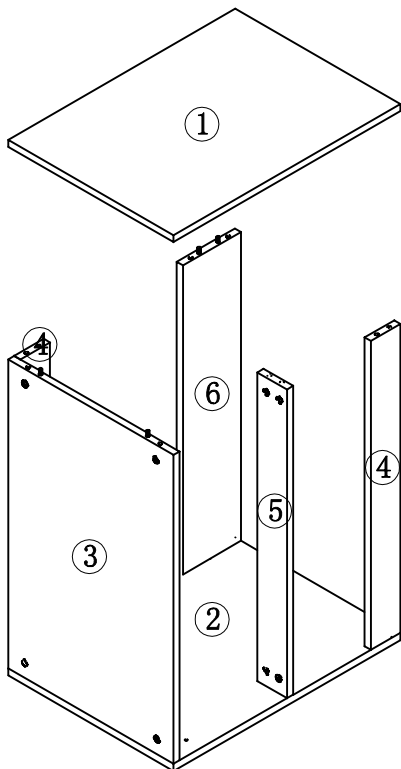

STEP 6

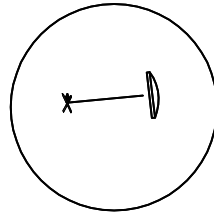

1. Connect No. 1 panel to No. 3-4-5-6 panel tightly with the three-in-one eccentric wheel.



2. Cover the mounting hole of the eccentric wheel with a three-in-one sticker.

HARDWARE LIST		
Three-in-one eccentric wheel A  7PCS	Three-in-one sticker C  7PCS	

STEP 7



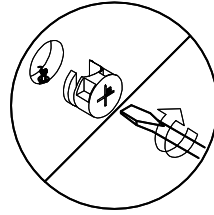
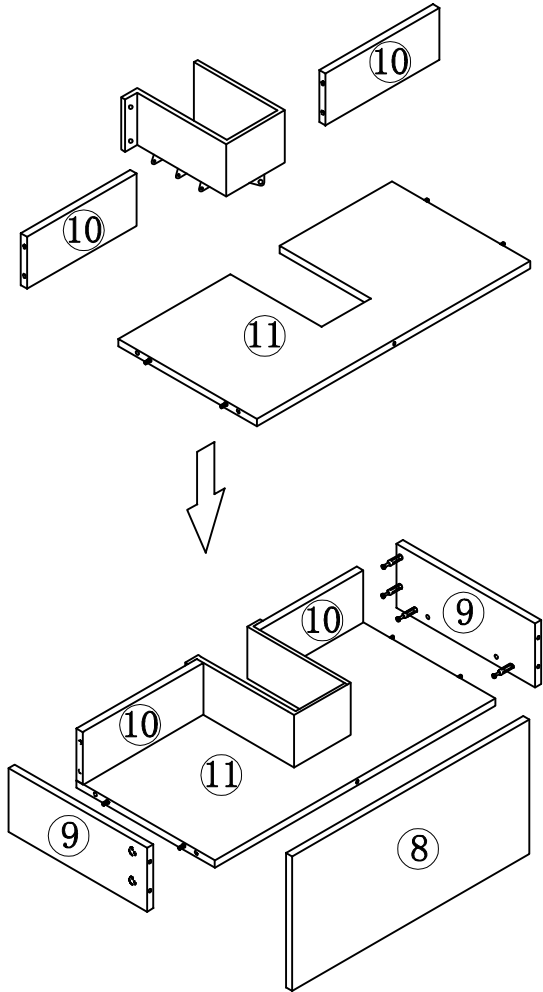

1. Install the Drawer U-shaped plastic with 4*16mm screws.

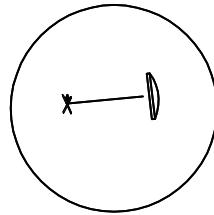

1. Install No. 8-9-10-11 panels with the three-in-one eccentric wheel tightly.



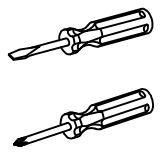

2. Cover the mounting hole of the eccentric wheel with a three-in-one sticker.

HARDWARE LIST		
Three-in-one eccentric wheel A  13PCS	Three-in-one sticker C  13PCS	
Drawer U-shaped plastic J  1PCS	4*16mm screw F  10PCS	

STEP 8

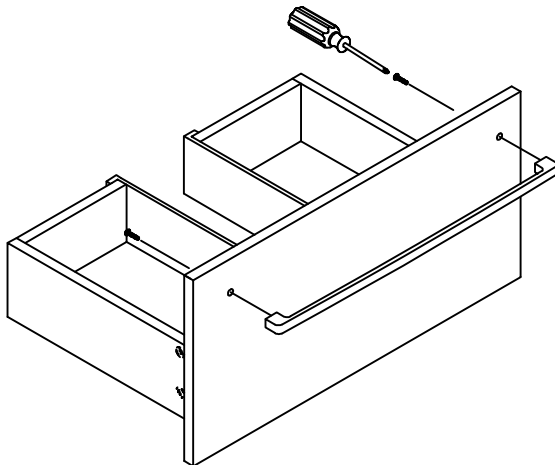
1. Install the drawer handle with 4*23 mm screws.

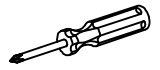

HARDWARE LIST		
4*23mm screw G  2PCS	Drawer handle H  1PCS	

STEP 9



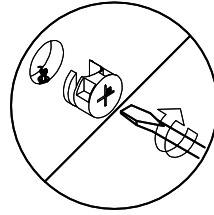
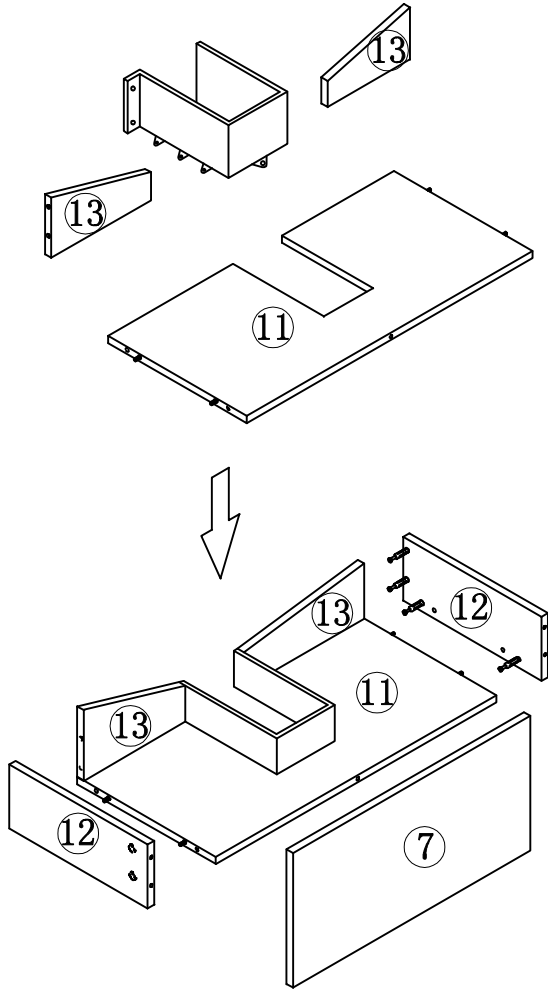

1. Install the Drawer U-shaped plastic with 4*16mm screws.

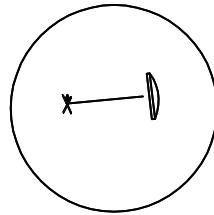

1. Install No. 7-11-12-13 panels with the three-in-one eccentric wheel tightly.



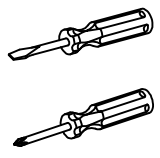

2. Cover the mounting hole of the eccentric wheel with a three-in-one sticker.

HARDWARE LIST		
Three-in-one eccentric wheel A  13PCS	Three-in-one sticker C  13PCS	
Drawer U-shaped plastic J  1PCS	4*16mm screw F  10PCS	

STEP 10

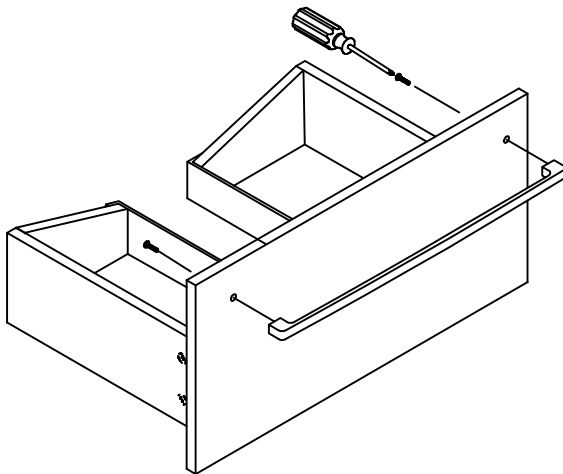
1. Install the drawer handle with 4*23 mm screws.



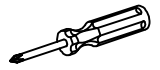

HARDWARE LIST		
4*23mm screw G  2PCS	Drawer handle H  1PCS	

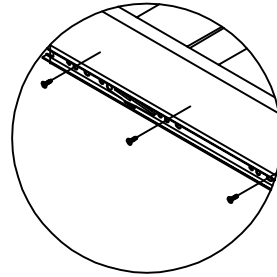
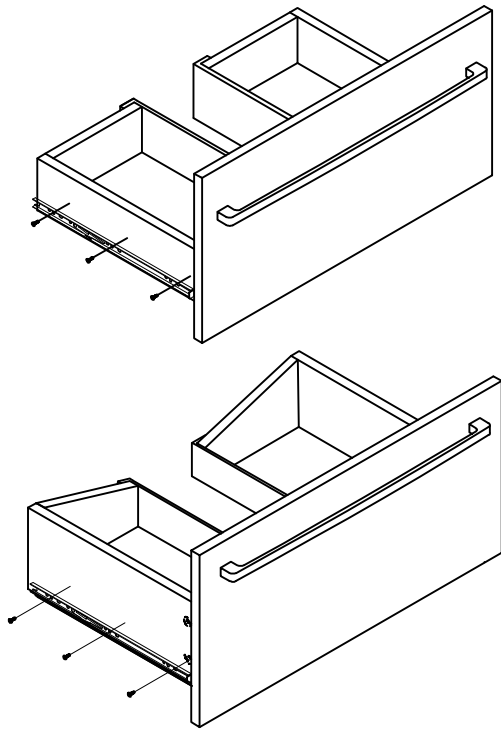
STEP 11

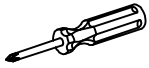

1.Lock the spare drawer slide block to the drawer.

HARDWARE LIST		
4*16mm screw	Drawer slides	
F  12PCS	E-2  4PCS	

STEP 12

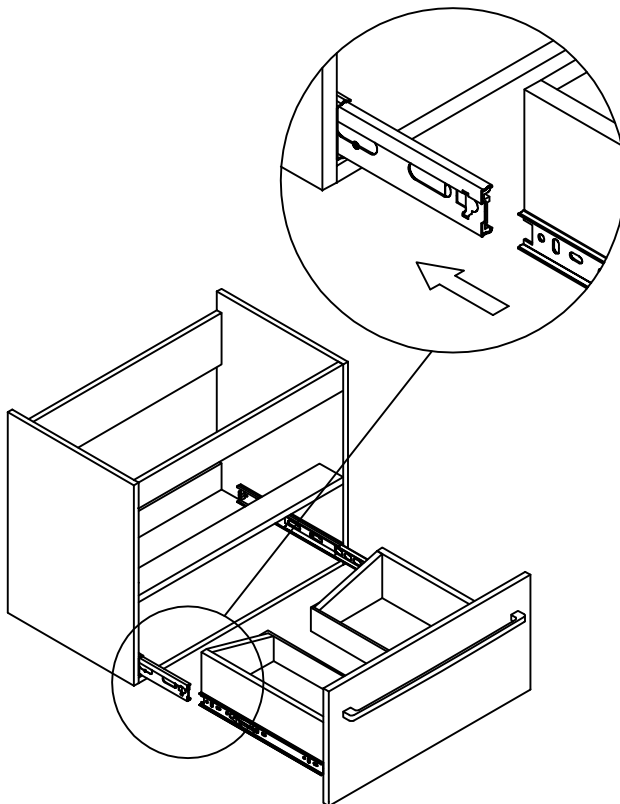

1.Align slide block with the trough on the guide rail, press the snap switch and press it forward to install the drawer.

STEP 13

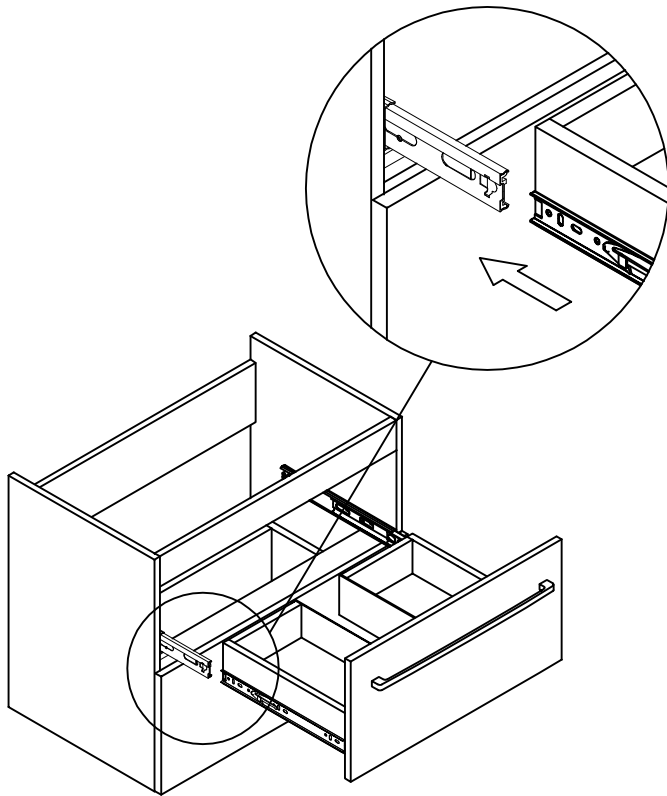

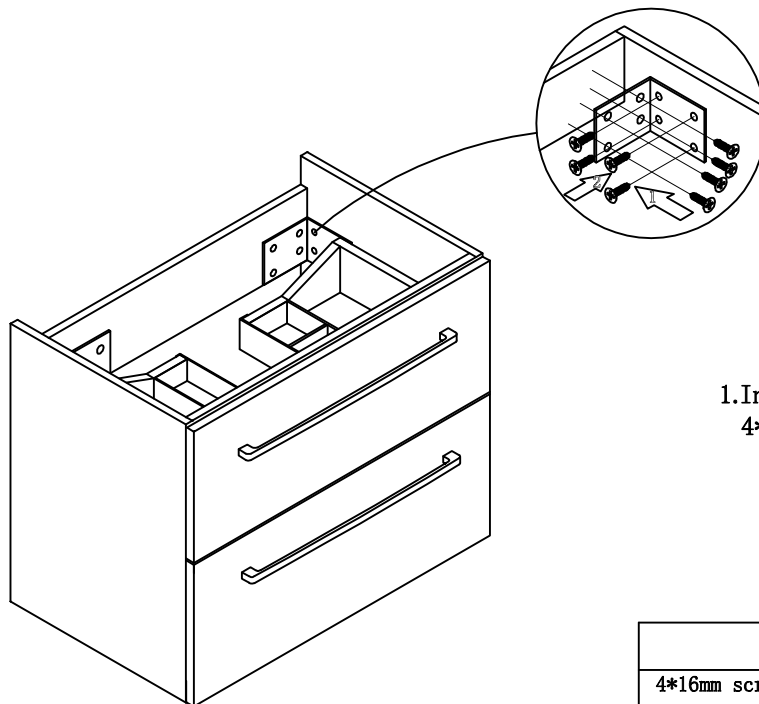

1.Align slide block with the trough on the guide rail, press the snap switch and press it forward to install the drawer.

STEP 14

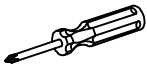

1.Install white angle bracket with 4*16mm screws.

HARDWARE LIST		
4*16mm screw	Drawer slides	
F  16PCS	I  2PCS	



Choking hazard-Small Parts : This unit contains small parts, not for children under 3 years.

Tip-over hazard : Secure finished unit to wall stud using L-Bracket and wall screw (#10*1.5"W/out provided). If a wall stud is not neccessible , Consault your local hardware store for appropriate mounting hardware . Failure to properly install will result in product collapse or tip-over. Serious injury can occur .