

Assembly Instructions

GUNDA-53 RND DINING TABLE

PLEASE NOTE: Check that you have received all components and hardware before assembling. If you are missing any parts, contact your retailer.

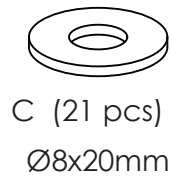
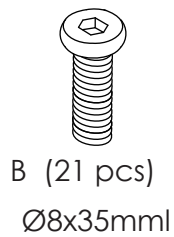
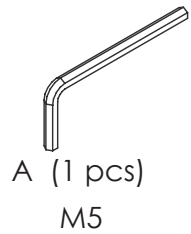
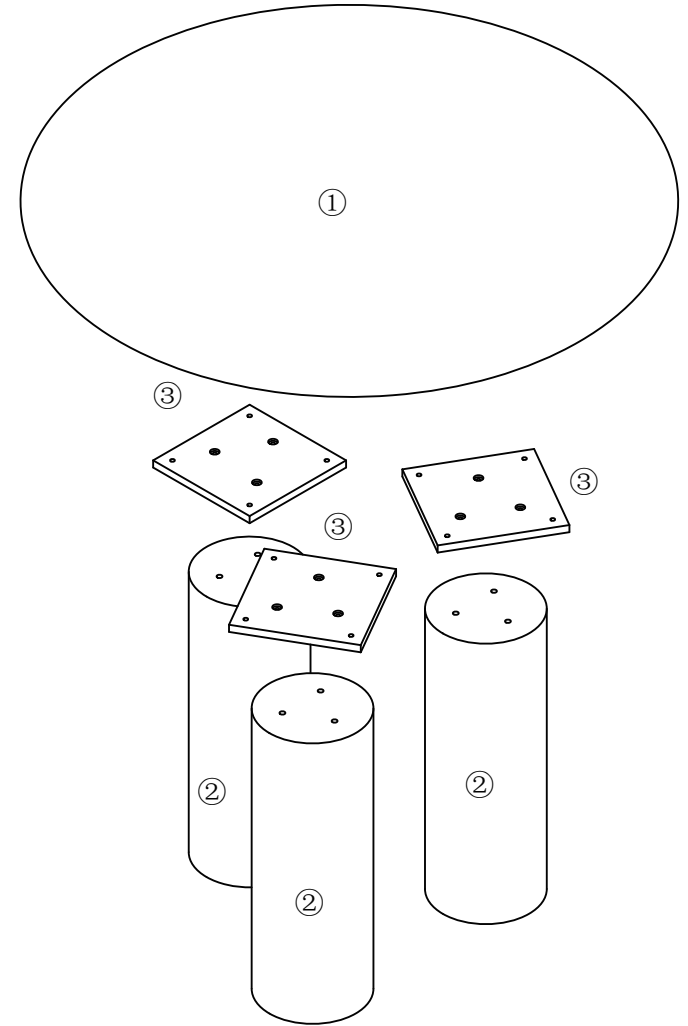

During assembly, hand tighten screws only. When the screws are in place, tighten completely.

Assembly Instructions

GUNDA-53 RND DINING TABLE

PLEASE NOTE: Check that you have received all components and hardware before assembling. If you are missing any parts, contact your retailer.

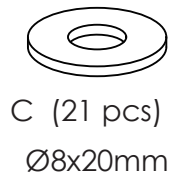
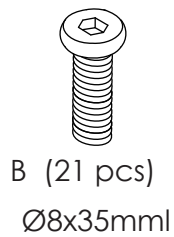
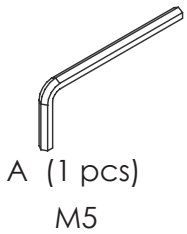
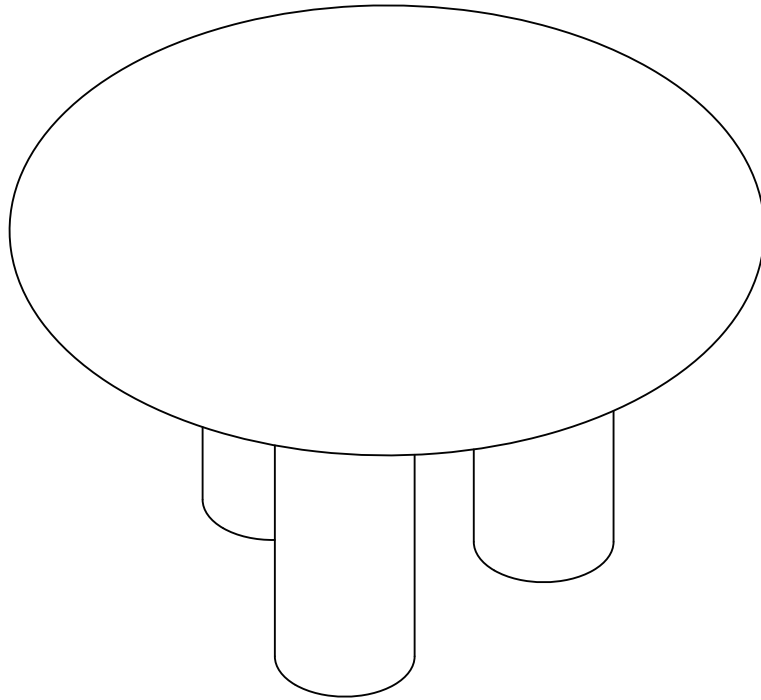

1.

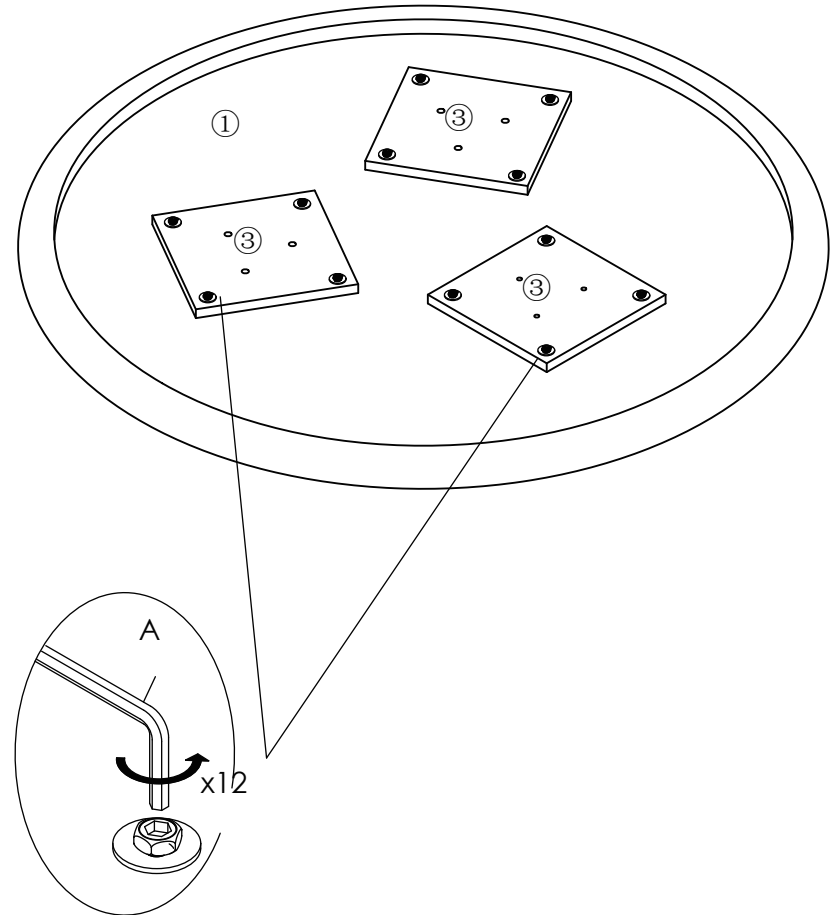

Remove the Connection plate before assembly.



During assembly, hand tighten screws only. When the screws are in place, tighten completely.

Assembly Instructions

GUNDA-53 RND DINING TABLE

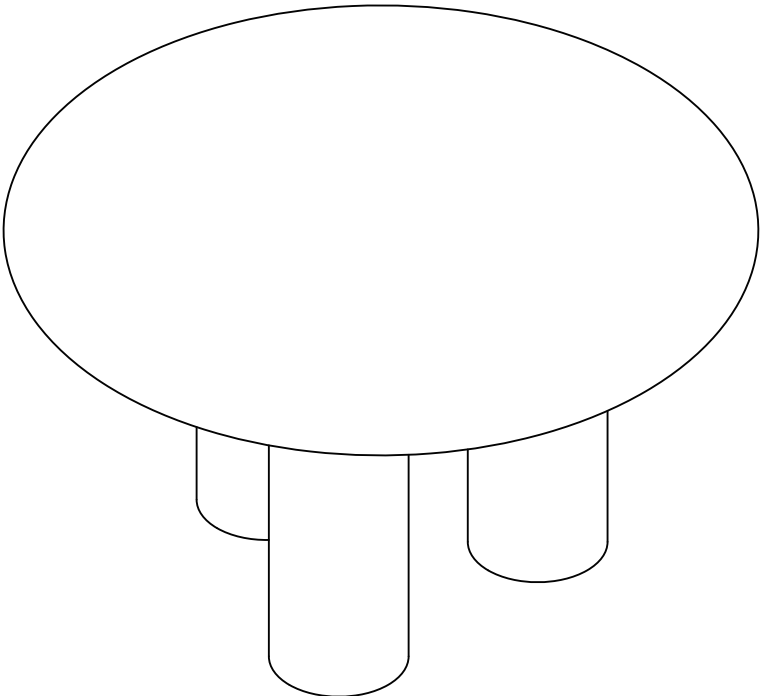
PLEASE NOTE: Check that you have received all components and hardware before assembling. If you are missing any parts, contact your retailer.

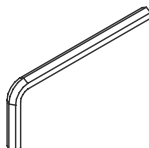
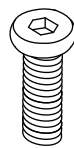

- 
 A (1 pcs)
 M5
- 
 B (21 pcs)
 Ø8x35mm
- 
 C (21 pcs)
 Ø8x20mm

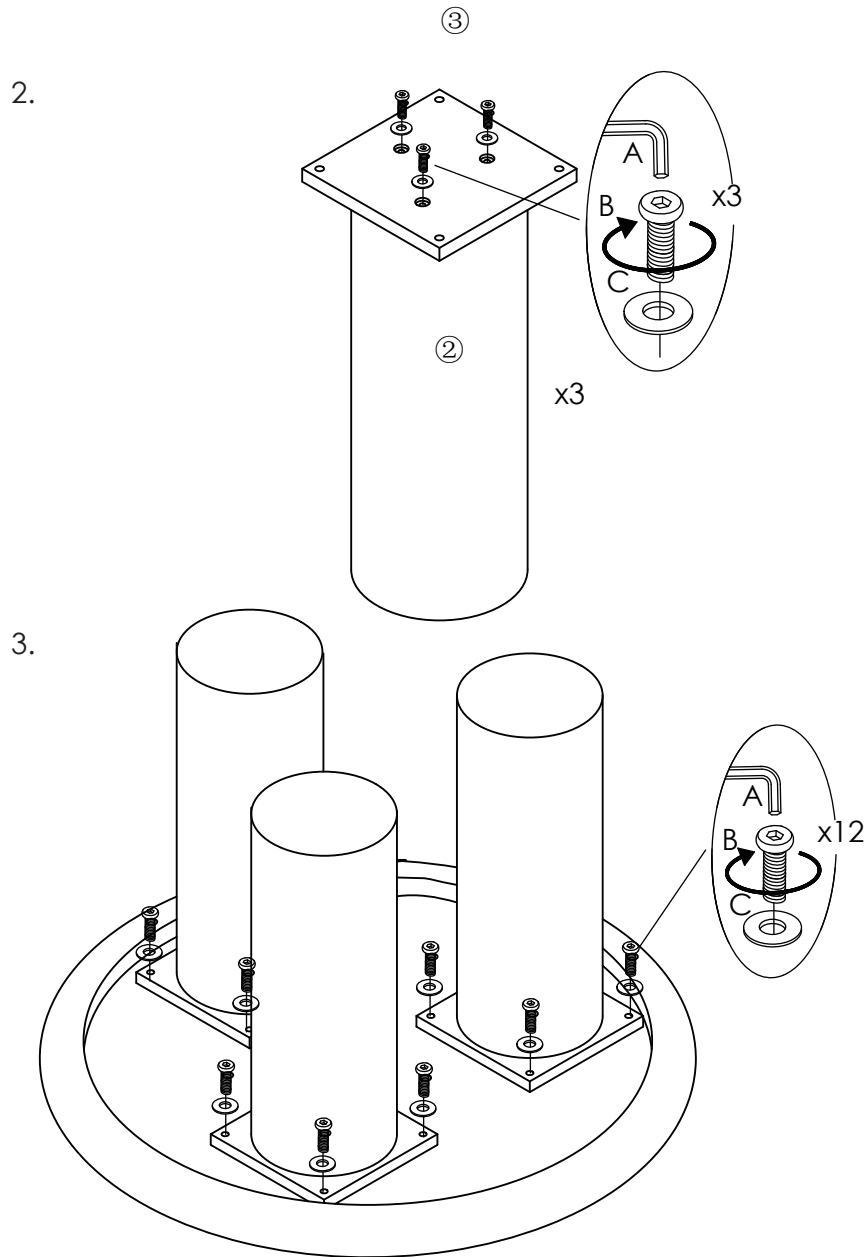

During assembly, hand tighten screws only. When the screws are in place, tighten completely.

Assembly Instructions

GUNDA-53 RND DINING TABLE

PLEASE NOTE: Check that you have received all components and hardware before assembling. If you are missing any parts, contact your retailer.

4.

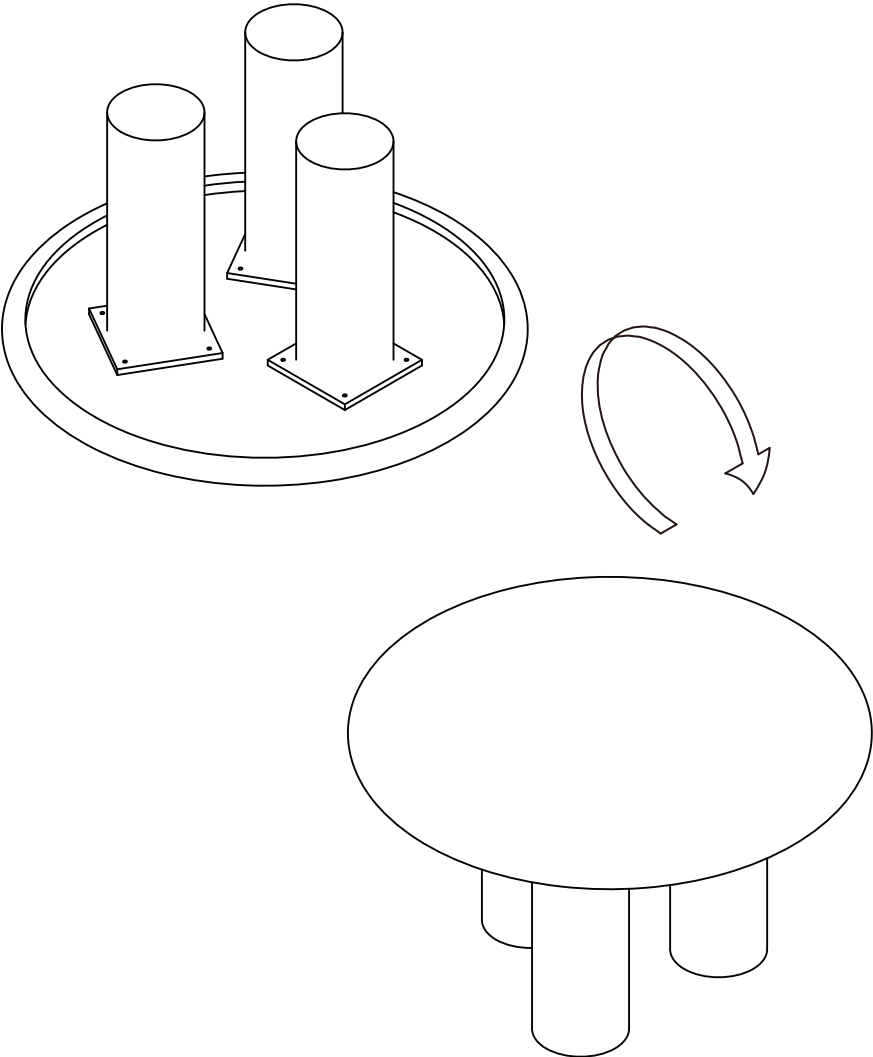
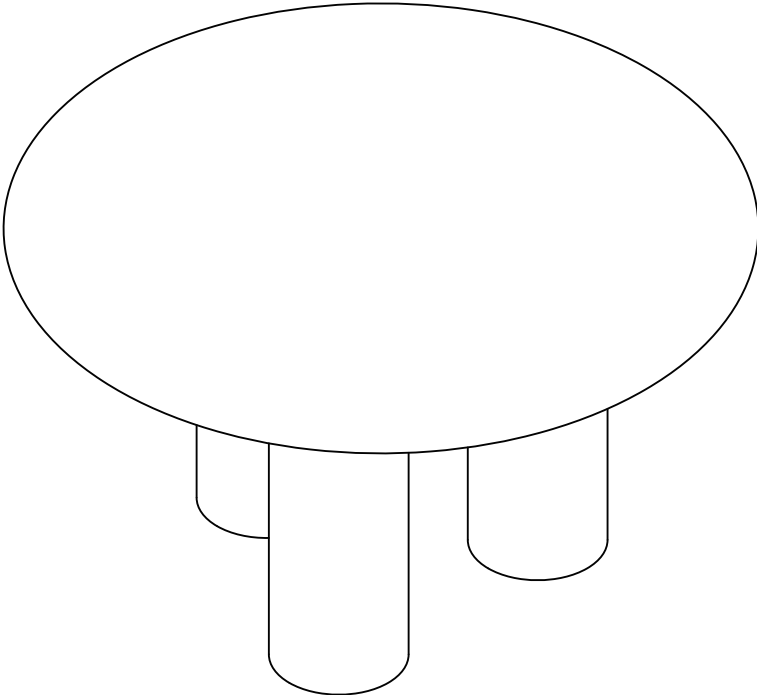

A (1 pcs)
M5

B (21 pcs)
Ø8x35mm

C (21 pcs)
Ø8x20mm

During assembly, hand tighten screws only. When the screws are in place, tighten completely.