

Cabinet > Manual

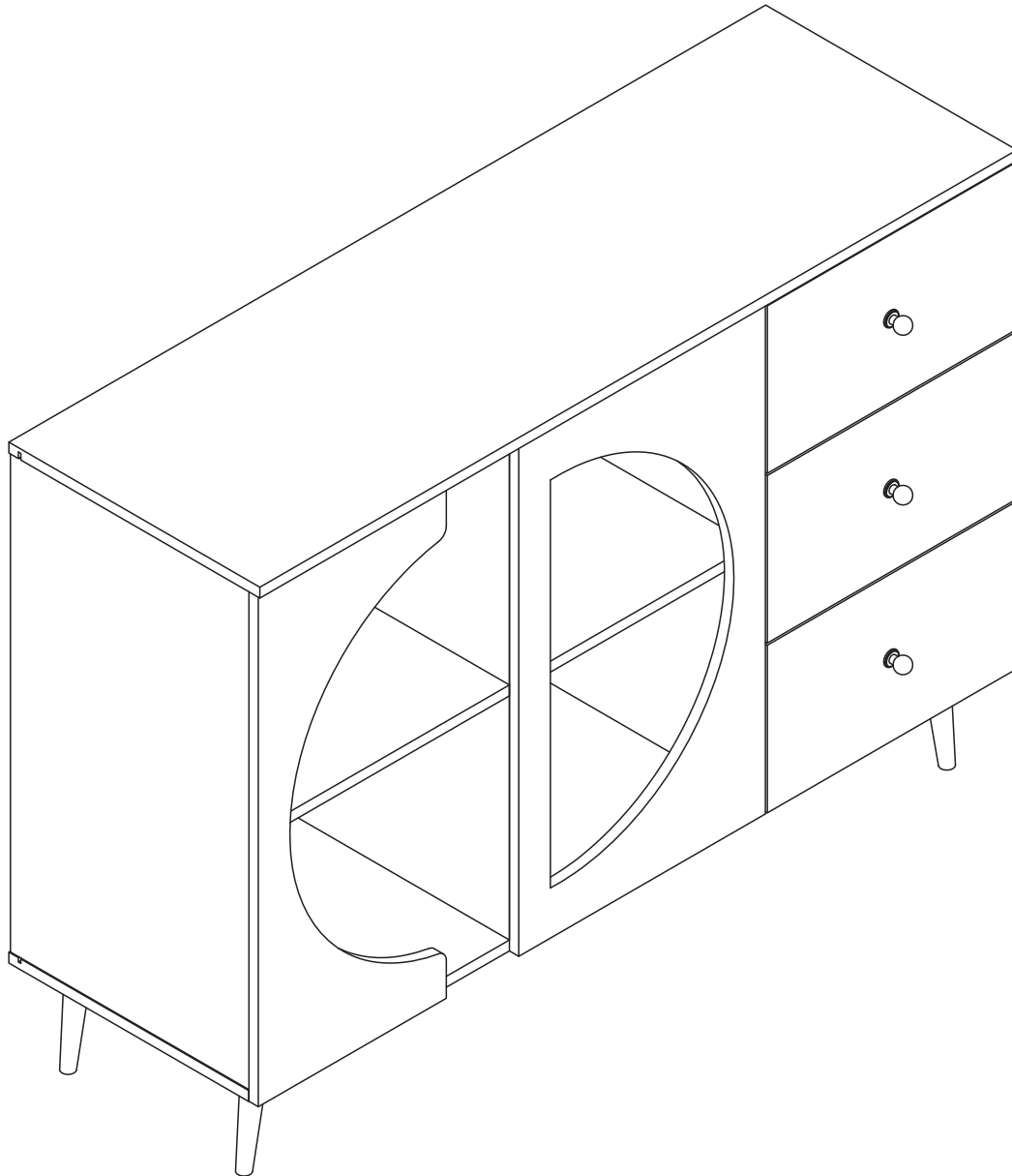

Thank you for purchase on our products. Please contact us if you have difficulty with assembly or need replacement parts. Our customer service is here to assist you. Please attach your User Name or Order ID so that we can assist you better.

Vielen Dank für Ihren Kauf von uns Produkten. Bitte kontaktieren Sie uns, wenn Sie Probleme mit Montage haben oder Ersatzteile benötigen. Wir Kundenservice ist für Sie da. Bitte geben Sie Ihren Benutzernamen oder Ihre Bestellnummer an, damit wir Sie besser unterstützen können.

EN

Thank you for purchase on our products. Please contact us if you have difficulty with assembly or need replacement parts. Our customer service is here to assist you. Please attach your User Name or Order ID so that we can assist you better.

WARNING

Serious or fatal injury may occur from unexpected assembly or use.

1. During the assembly process, keep all parts away from babies or children.
2. Always securely fix this product to the wall. Make sure the wall area to be drilled is free from hidden electrical wires, water and gas pipes.
3. Use of tip-over restraints may only reduce, but not eliminate the risk of tip-over.
4. Unless specially designed to accommodate, do not set heavy objects on top of this product.
5. Place the heaviest items on the lowest shelf.
6. Never allow children to climb or bang on drawers, doors or shelves.

DE

Vielen Dank für Ihren Kauf von uns Produkten. Bitte kontaktieren Sie uns, wenn Sie Probleme mit Montage haben oder Ersatzteile benötigen. Wir Kundenservice ist für Sie da. Bitte geben Sie Ihren Benutzernamen oder Ihre Bestellnummer an, damit wir Sie besser unterstützen können.

WARNUNG







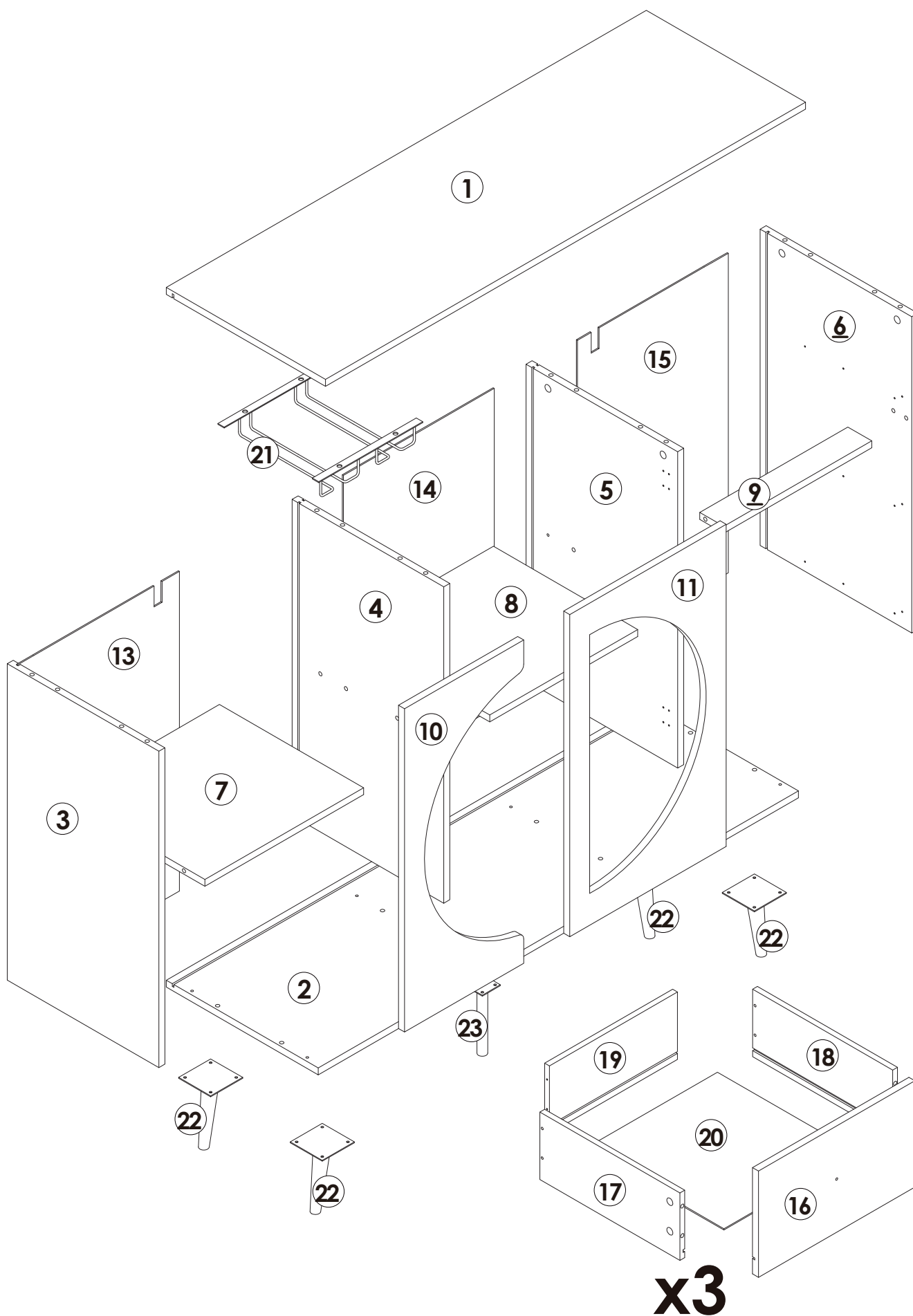



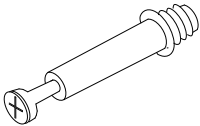
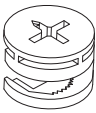
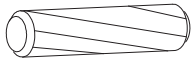

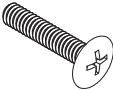
Bei unerwarteter Montage oder Verwendung können schwere oder tödliche Verletzung auftreten.

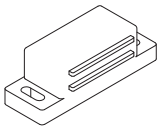
1. Legen Sie in den Montageprozess alle Teile weg von Babys oder Kindern.
2. Stellen Sie sicher, dass der gebohrte Wandbereich frei von verborgenen Stromkabeln, Wasser- und Gasleitungen ist, wenn Sie dieses Produkt an der Wand befestigen.
3. Die Verwendung von Kippsicherungen kann die Gefahr eines Kippens nur verringern, jedoch nicht beseitigen.
4. Setzen Sie bitte keine schweren Gegenstände auf dieses Produkt, es sei denn, dass das Produkt speziell für die Unterbringung konzipiert wird.
5. Legen Sie bitte die schwersten Gegenstände auf das unterste Regal.
6. Erlauben Sie nie Kindern, auf Schubladen, Türen oder Regale zu klettern oder zu knallen.

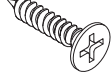
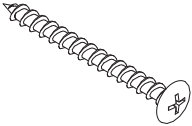
Parts List(EN) / Teile Liste(DE)

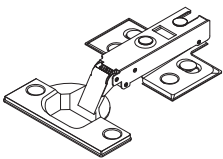
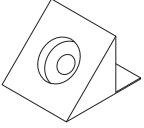
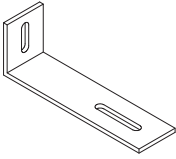

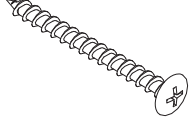
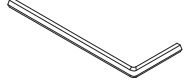
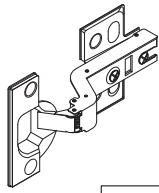

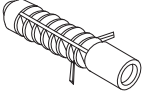
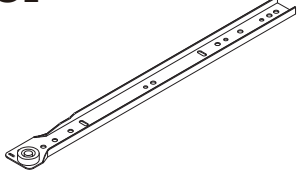
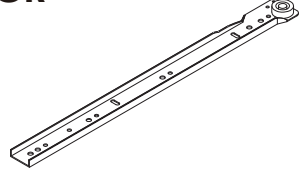
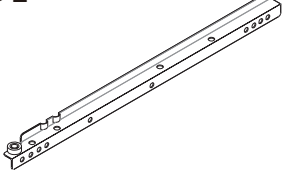
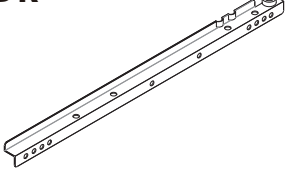

Parts List(EN) / Teile Liste(DE)

<p>A</p>  <p>M6×35mm 30+2PCS</p>	<p>B</p>  <p>Ø15×9mm 30+2PCS</p>	<p>C</p>  <p>Ø6×30mm 26+2PCS</p>	<p>D</p>  <p>3PCS</p>
<p>E</p>  <p>M4×20mm 3PCS</p>	<p>F</p>  <p>M4×30mm 12+1PCS</p>	<p>G</p>  <p>4PCS</p>	<p>H</p>  <p>4PCS</p>
<p>I</p>  <p>M3×12mm 4PCS</p>	<p>J</p>  <p>M3×16mm 32+2PCS</p>	<p>K</p>  <p>M4×40mm 8+1PCS</p>	<p>L</p>  <p>M6×12mm 4PCS</p>
<p>M</p>  <p>M4×12mm 22+2PCS</p>	<p>N</p>  <p>2PCS</p>	<p>O</p>  <p>24+2PCS</p>	<p>P</p>  <p>2PCS</p>
<p>Q</p>  <p>M3.5×12mm 42+2PCS</p>	<p>R</p>  <p>M4×35mm 2PCS</p>	<p>S</p>  <p>1PC</p>	<p>T</p>  <p>2PCS</p>
<p>U</p>  <p>M4×14mm 24+2PCS</p>	<p>V</p>  <p>Ø6×30mm 2PCS</p>		
<p>CL</p>  <p>L300mm 3PCS</p>	<p>CR</p>  <p>L300mm 3PCS</p>	<p>DL</p>  <p>L300mm 3PCS</p>	<p>DR</p>  <p>L300mm 3PCS</p>

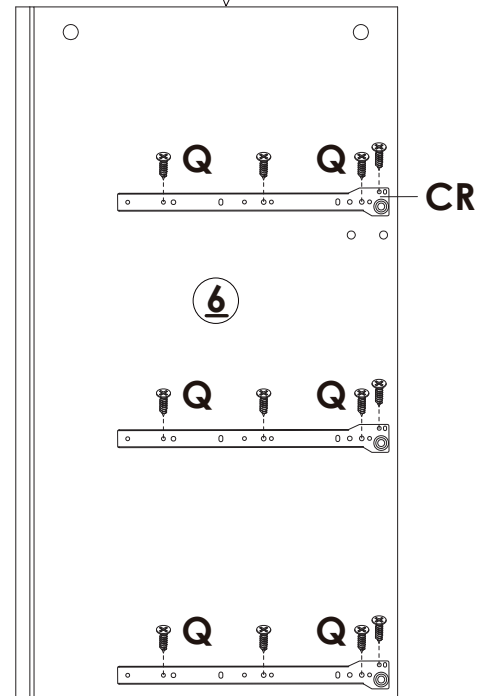
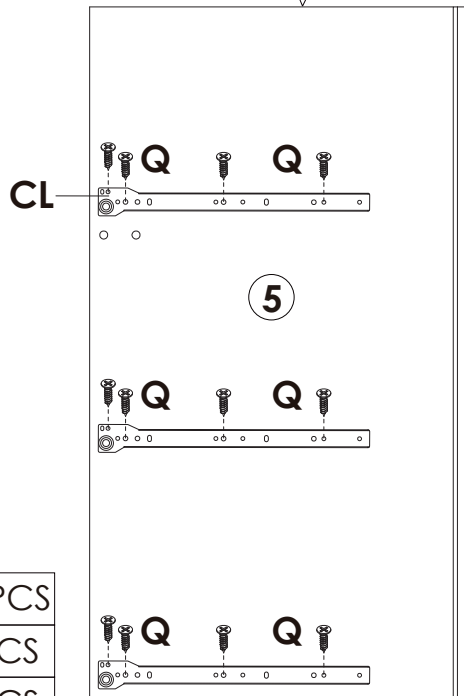
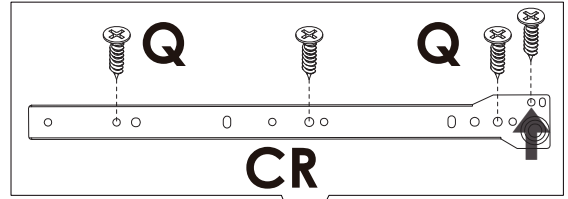
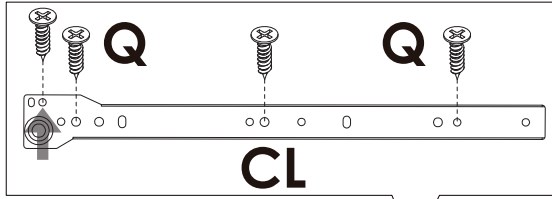
Assembly Steps(EN) / Montageschritte(DE)

STEP 1



	Q x 24PCS
	CL x 3PCS
	CR x 3PCS

STEP 2

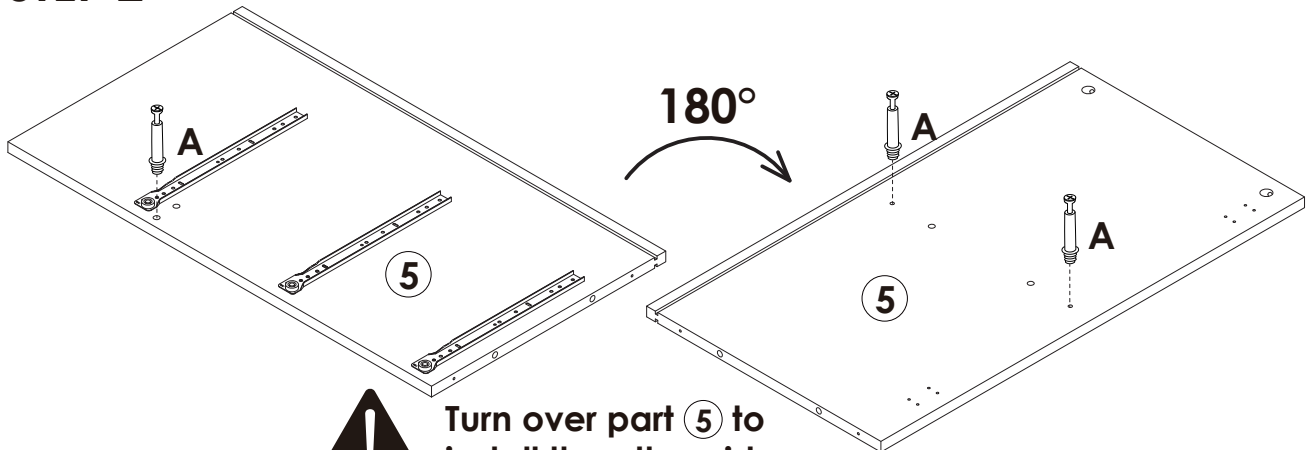

	A x 4PCS
-------------------------------------------------------------------------------------	----------

Assembly Steps(EN) / Montageschritte(DE)

STEP 3

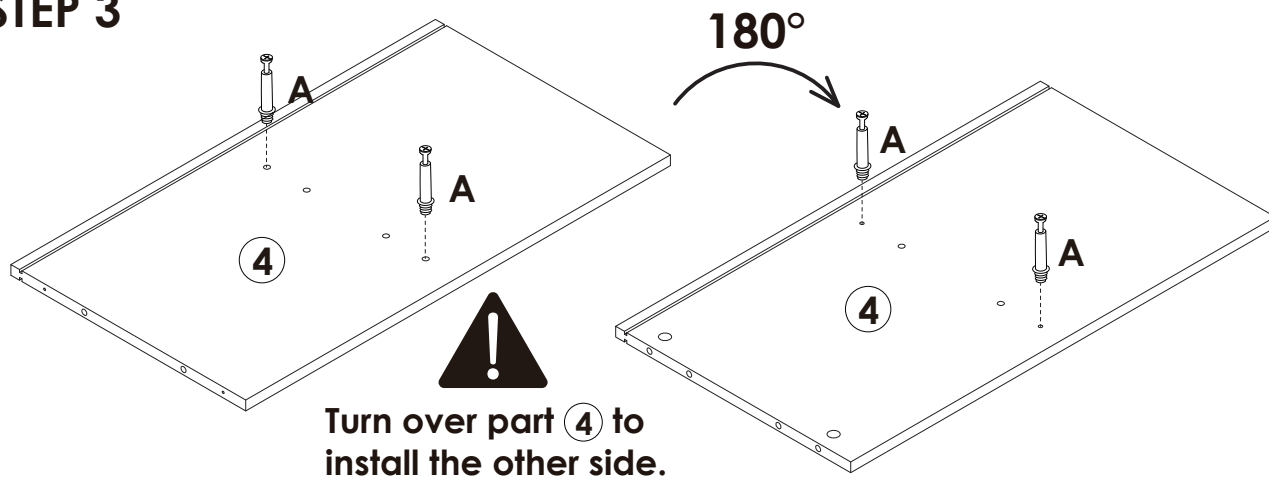

Turn over part ④ to install the other side.

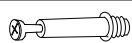
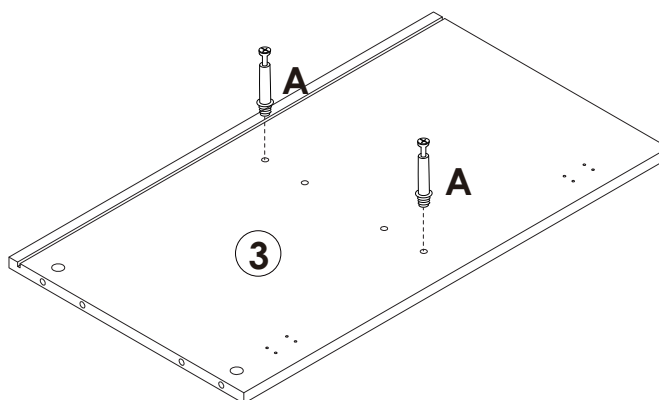

A x 6PCS

STEP 4

Lock the long side of the "P" L-shaped metal plate to the ① board with the "M" short screw

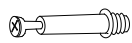
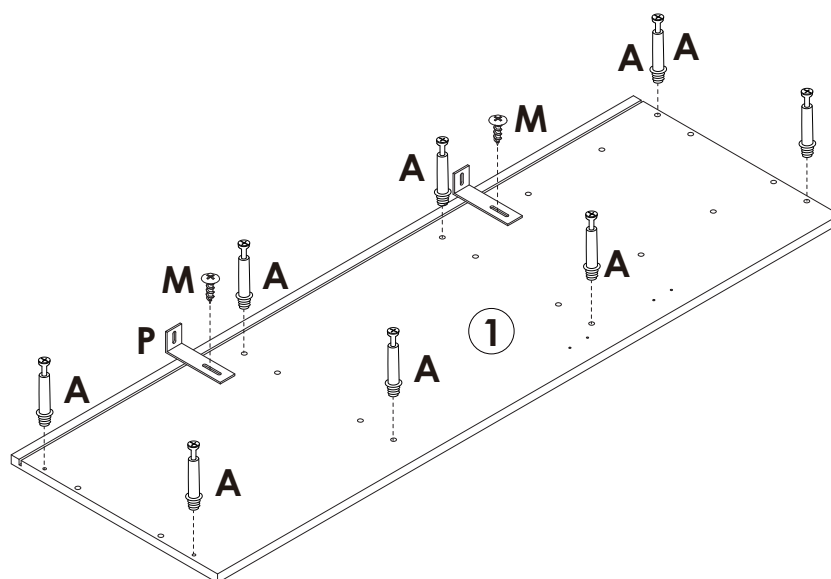

A x 8PCS



M x 2PCS





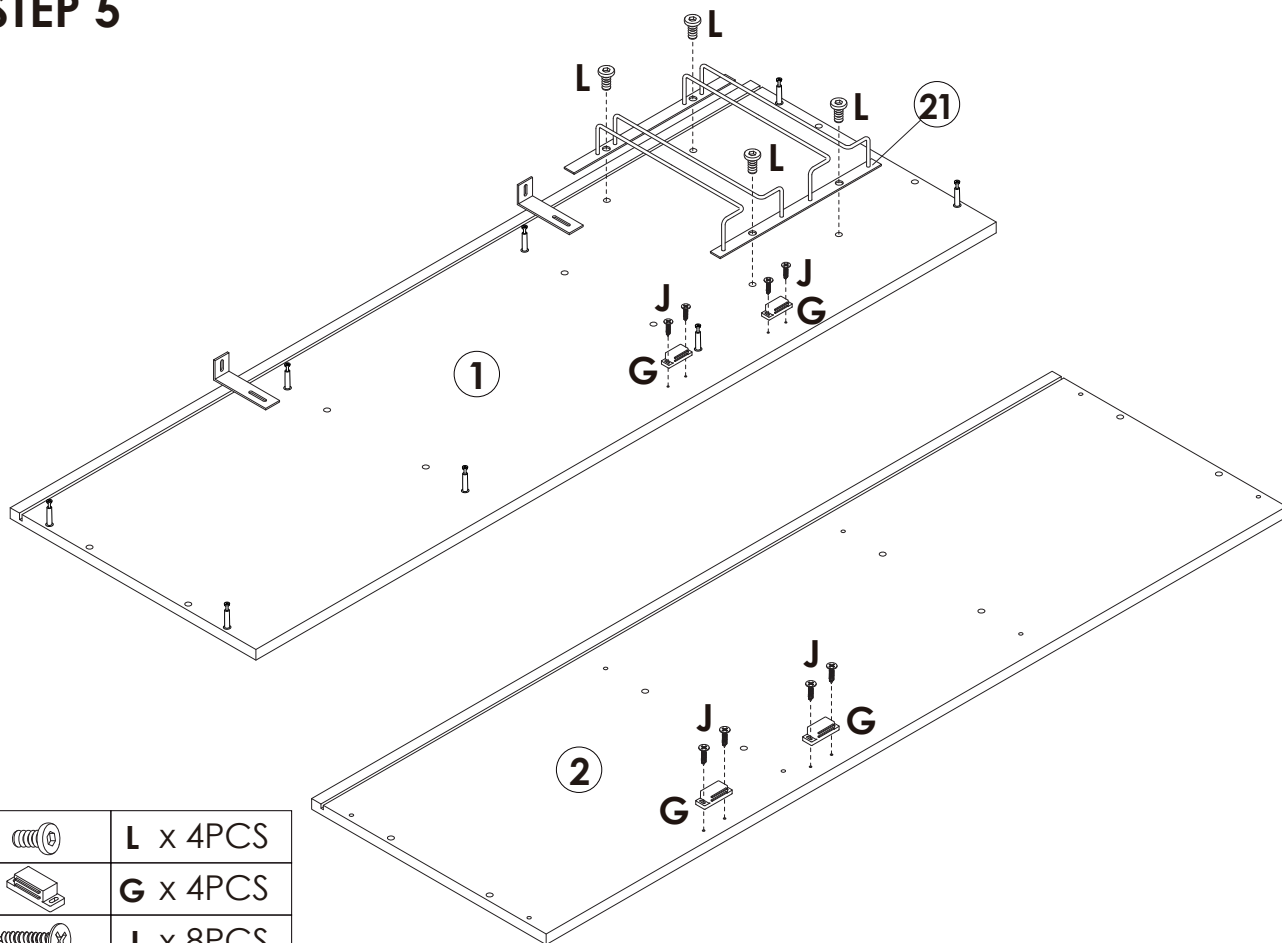

P x 2PCS

Assembly Steps(EN) / Montageschritte(DE)



STEP 5

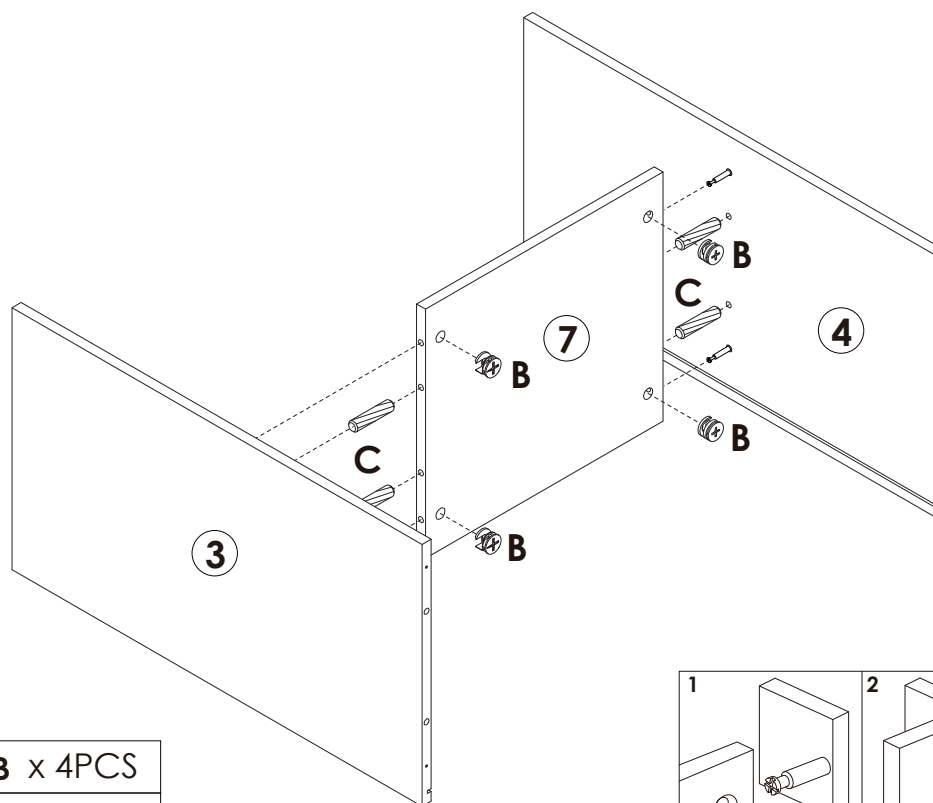

	L x 4PCS
	G x 4PCS
	J x 8PCS
	S x 1PC

STEP 6



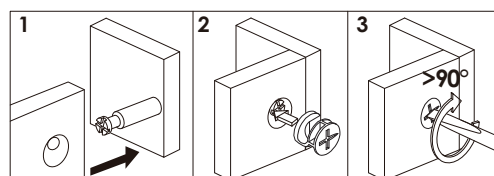

	B x 4PCS
	C x 4PCS



Assembly Steps(EN) / Montageschritte(DE)

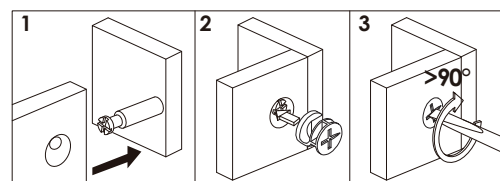
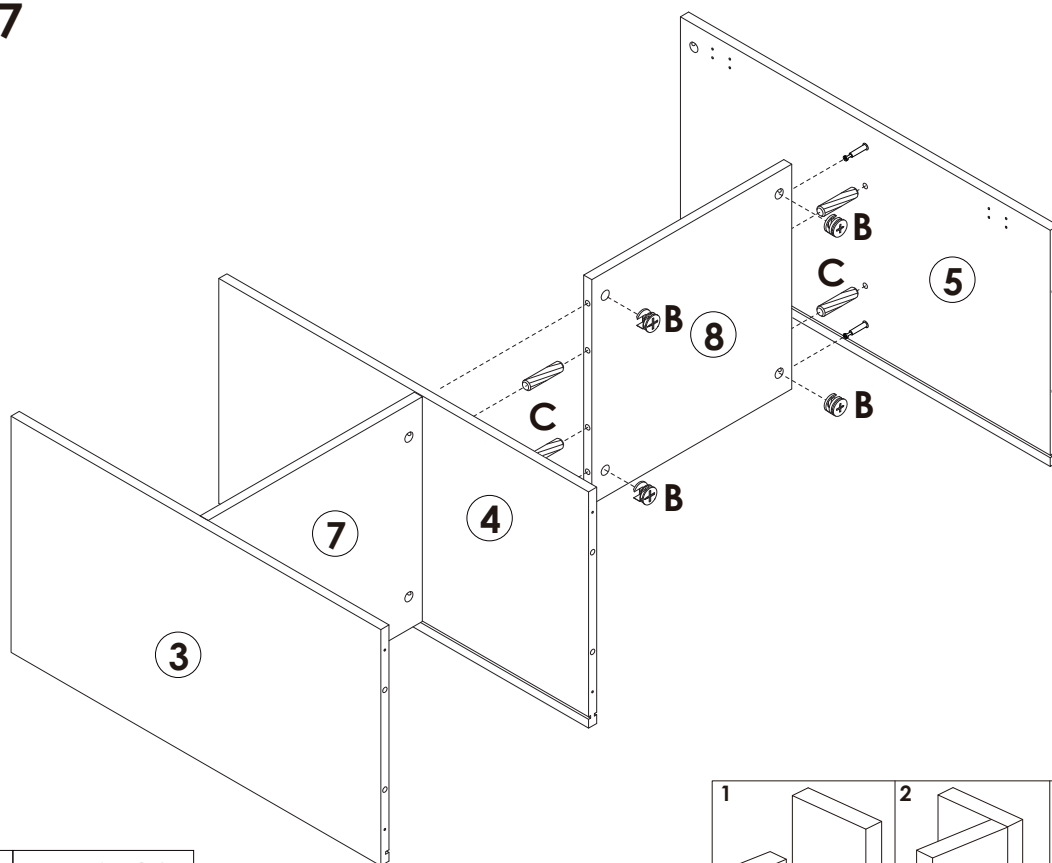

STEP 7

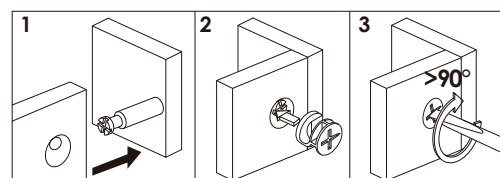
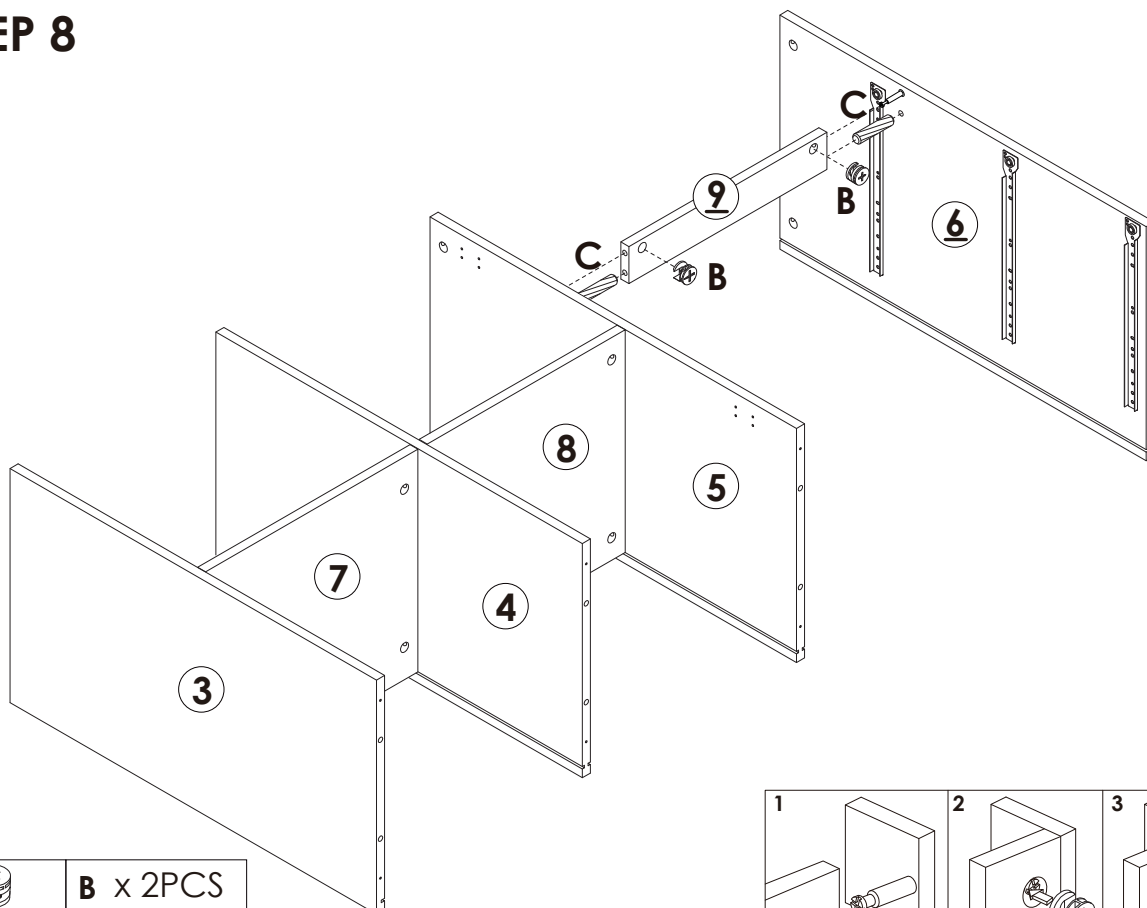

	B x 4PCS
	C x 4PCS

STEP 8





	B x 2PCS
	C x 2PCS

Assembly Steps(EN) / Montageschritte(DE)

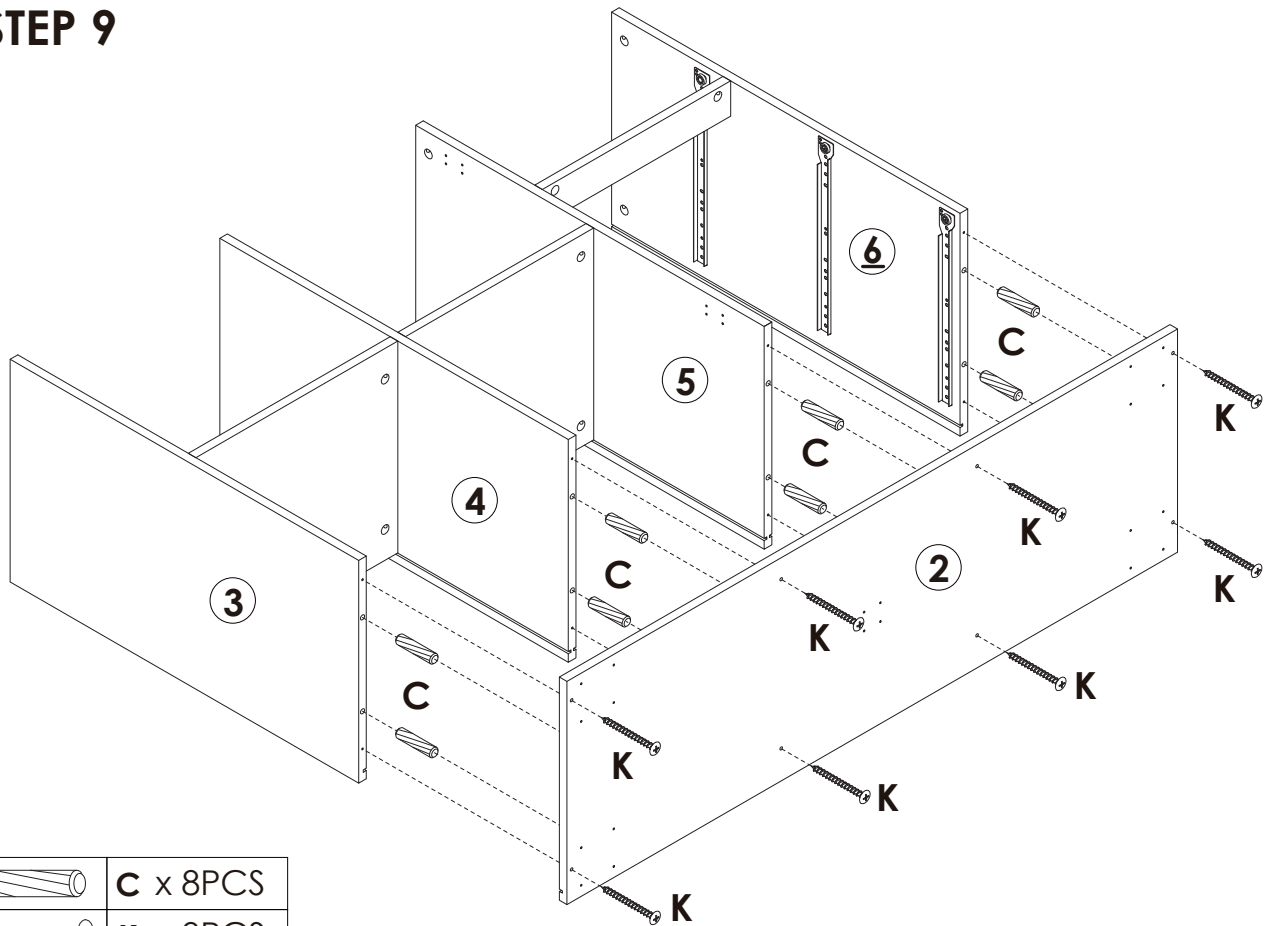
STEP 9



	C x 8PCS
	K x 8PCS

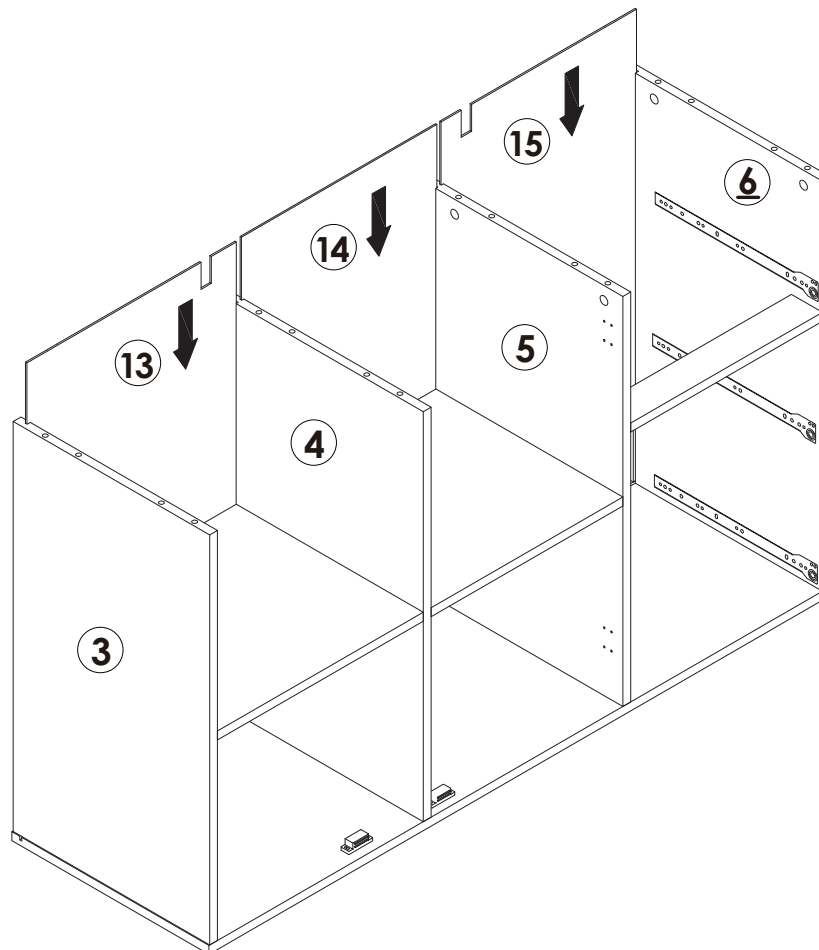

STEP 10

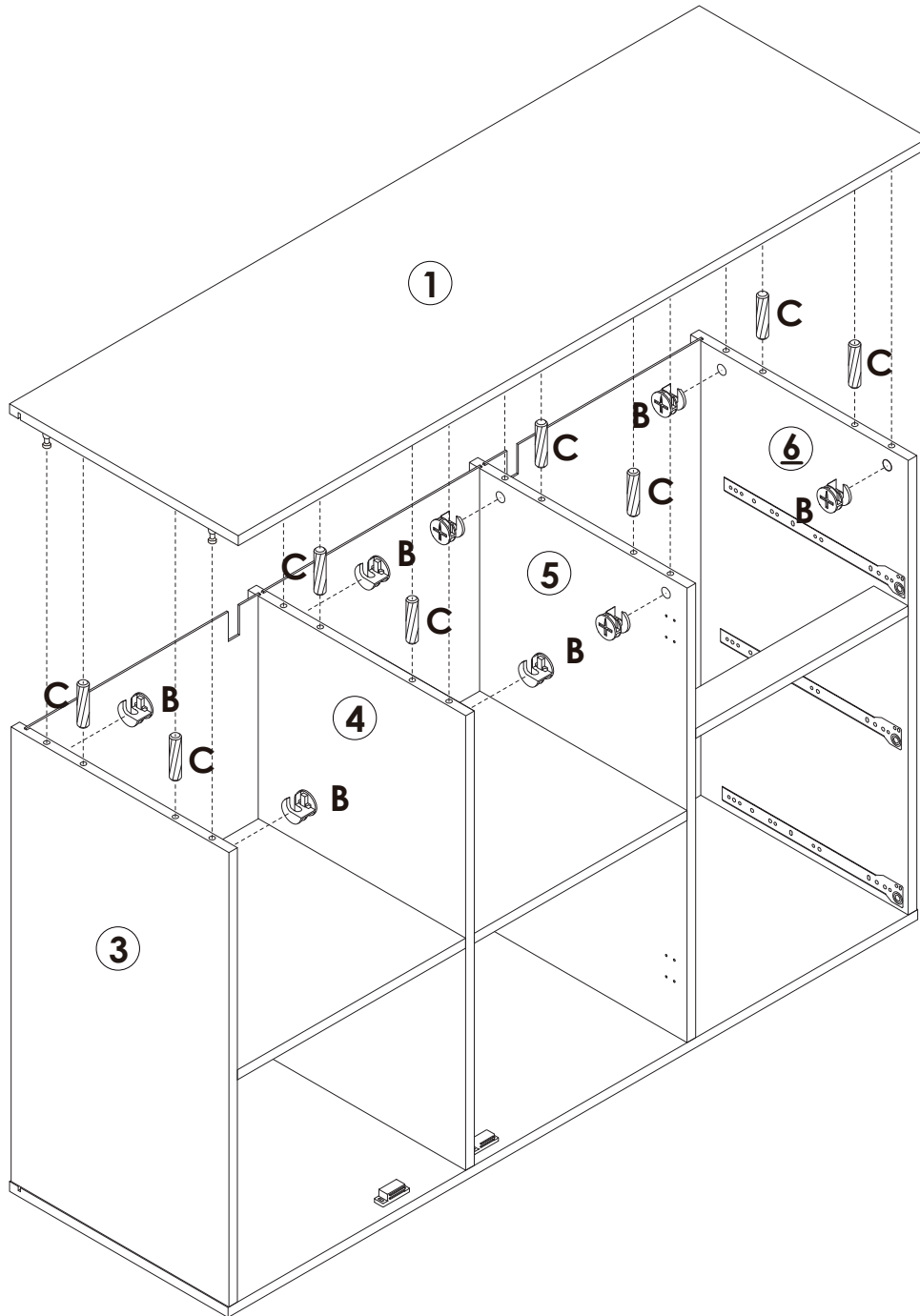

Assembly Steps(EN) / Montageschritte(DE)

STEP 11



	B x 8PCS
	C x 8PCS

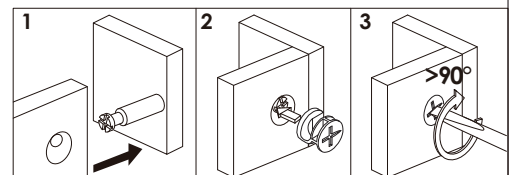

Assembly Steps(EN) / Montageschritte(DE)

STEP 12

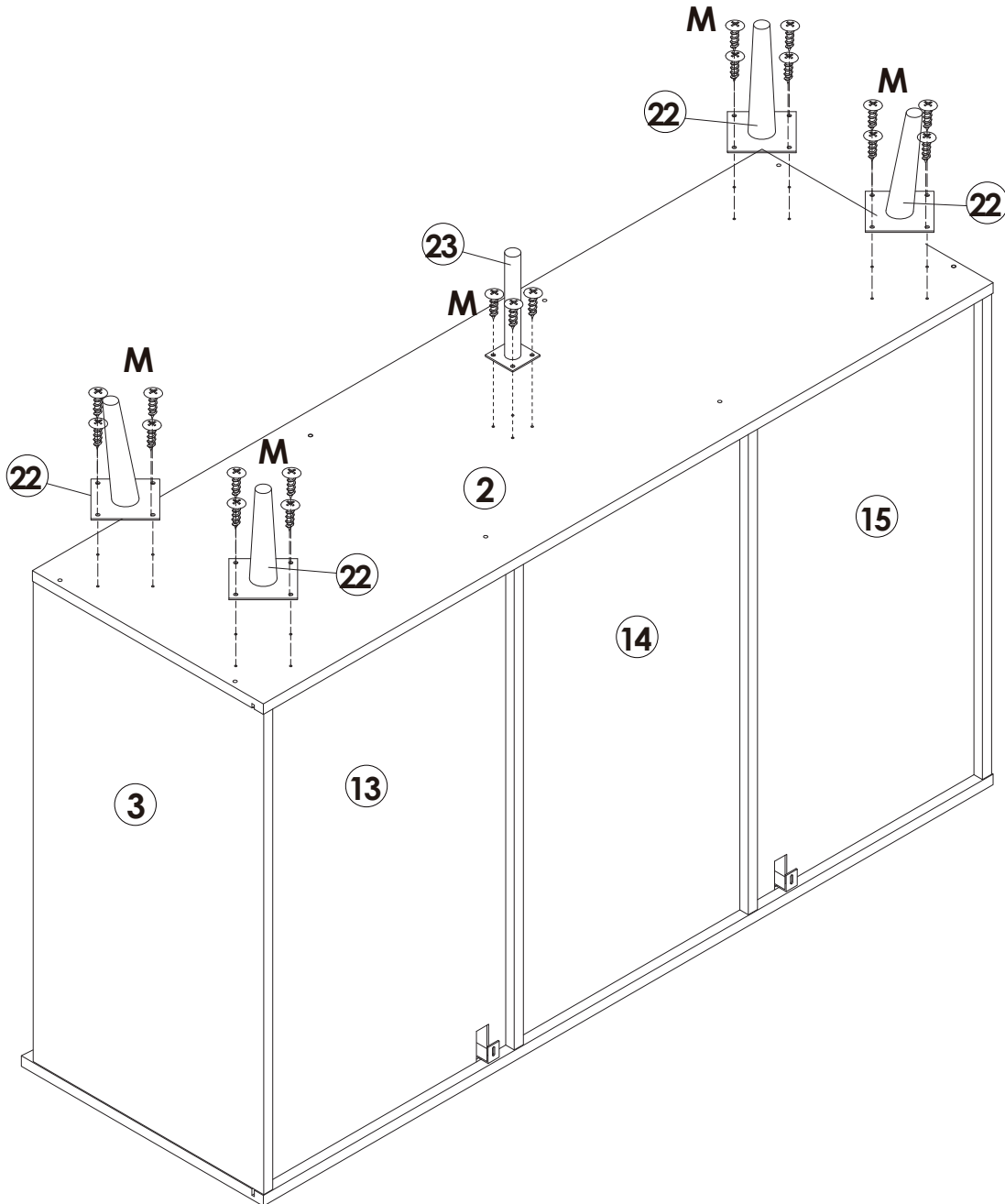



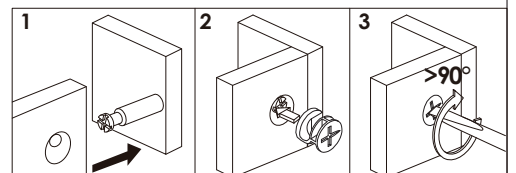

M x 20PCS

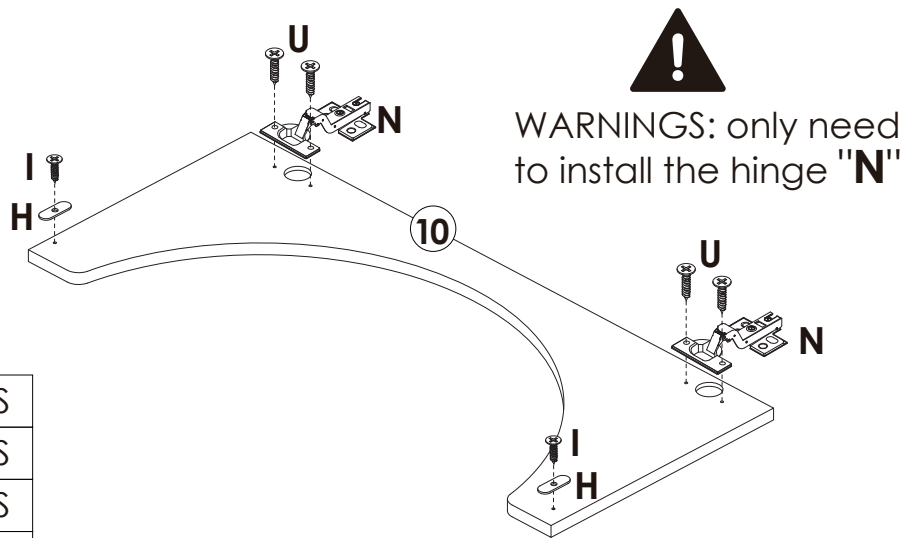

Assembly Steps(EN) / Montageschritte(DE)

STEP 13



	H x 2PCS
	I x 2PCS
	U x 4PCS
	N x 2PCS

STEP 14

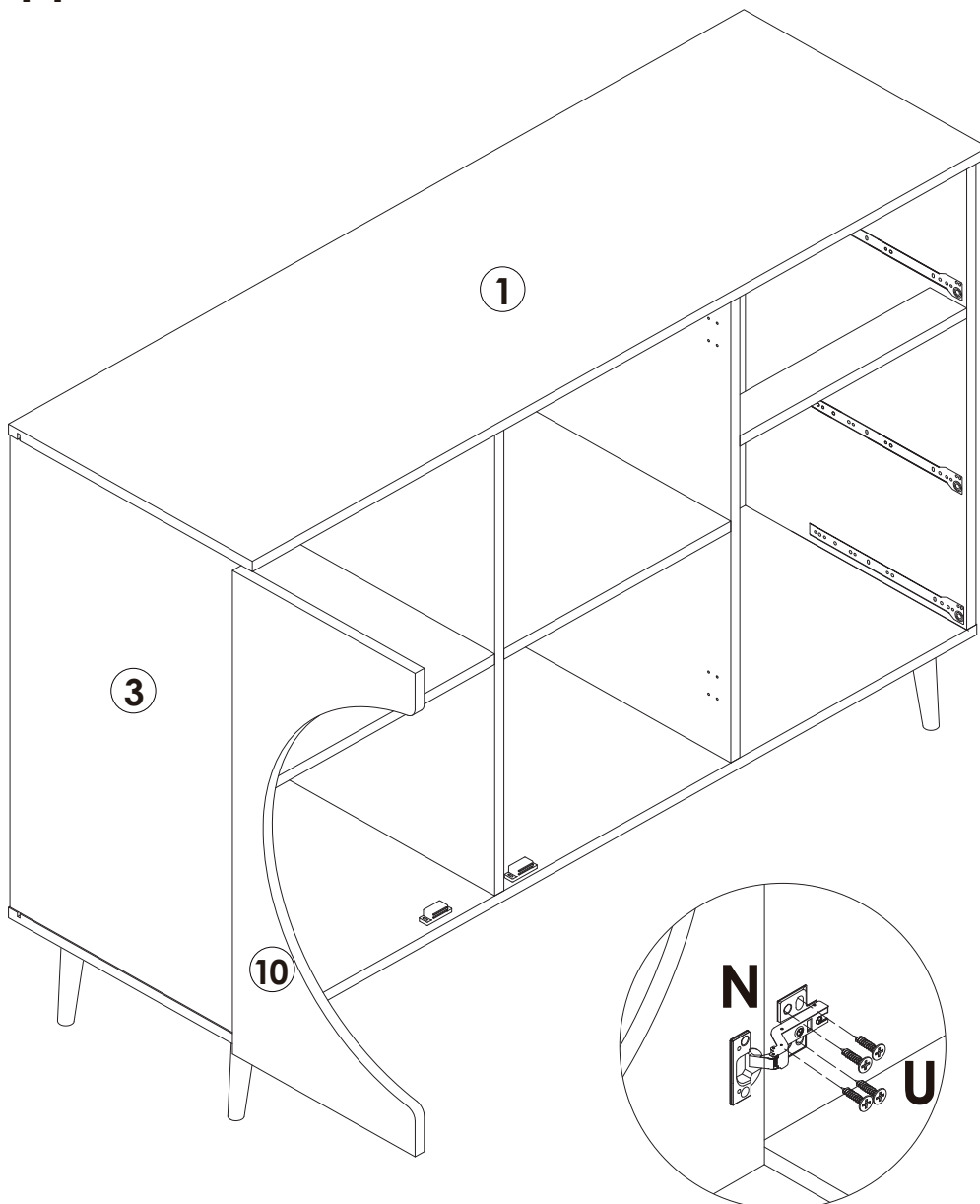

	U x 8PCS
-------------------------------------------------------------------------------------	----------

Assembly Steps(EN) / Montageschritte(DE)

STEP 15



WARNINGS: only need
to install the hinge "T"

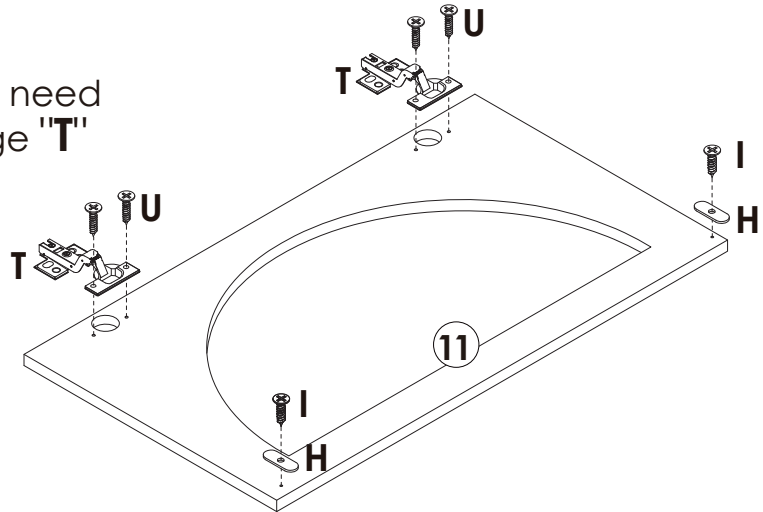

	H x 2PCS
	I x 2PCS
	U x 4PCS
	T x 2PCS

STEP 16

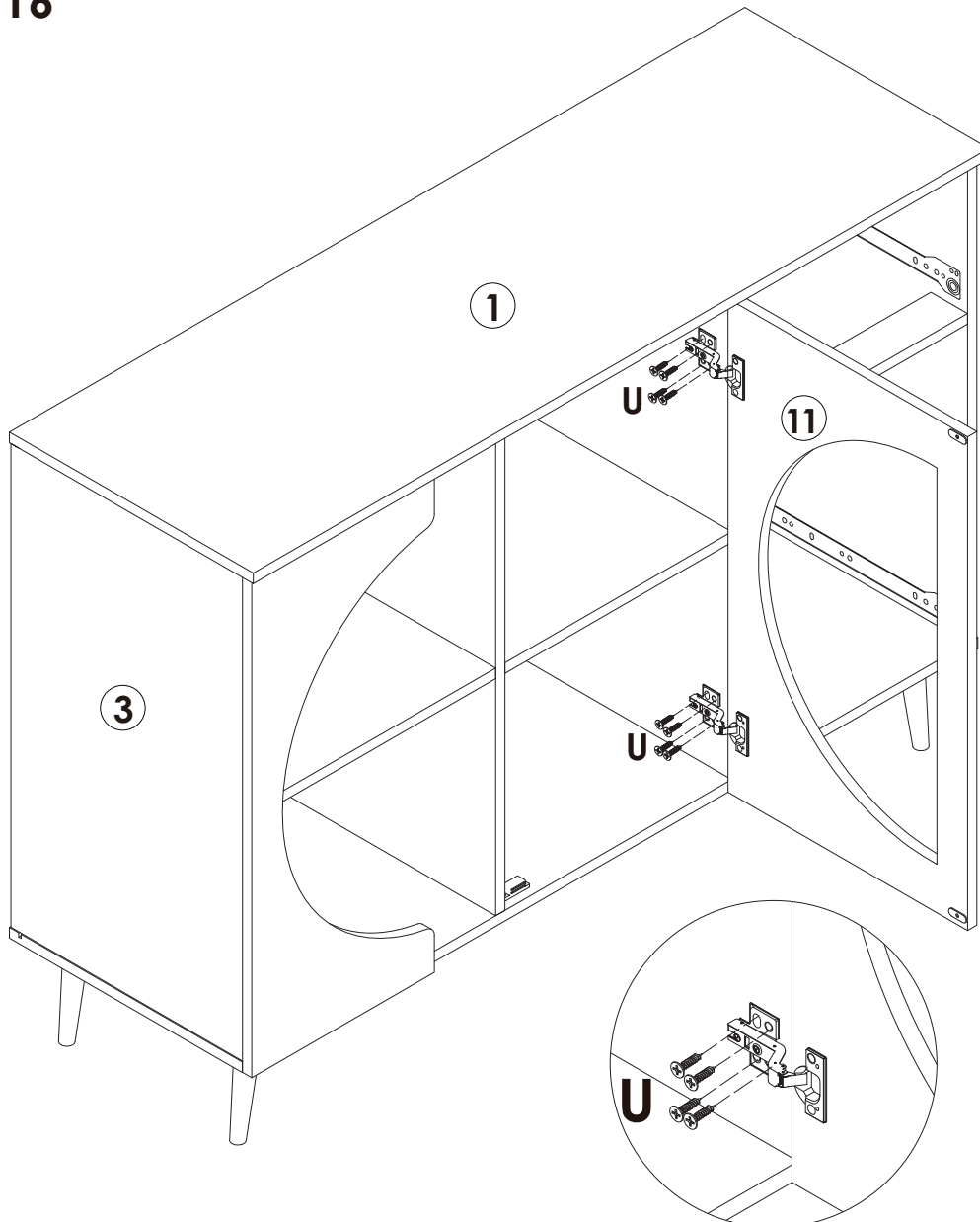

	U x 8PCS
--	----------

Assembly Steps(EN) / Montageschritte(DE)

STEP 17

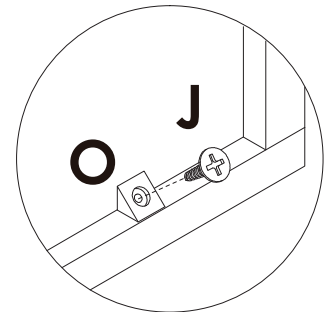
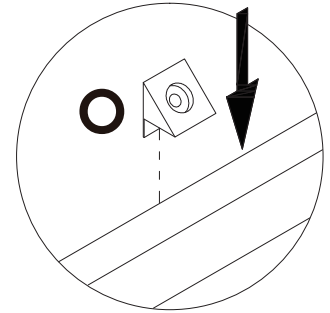
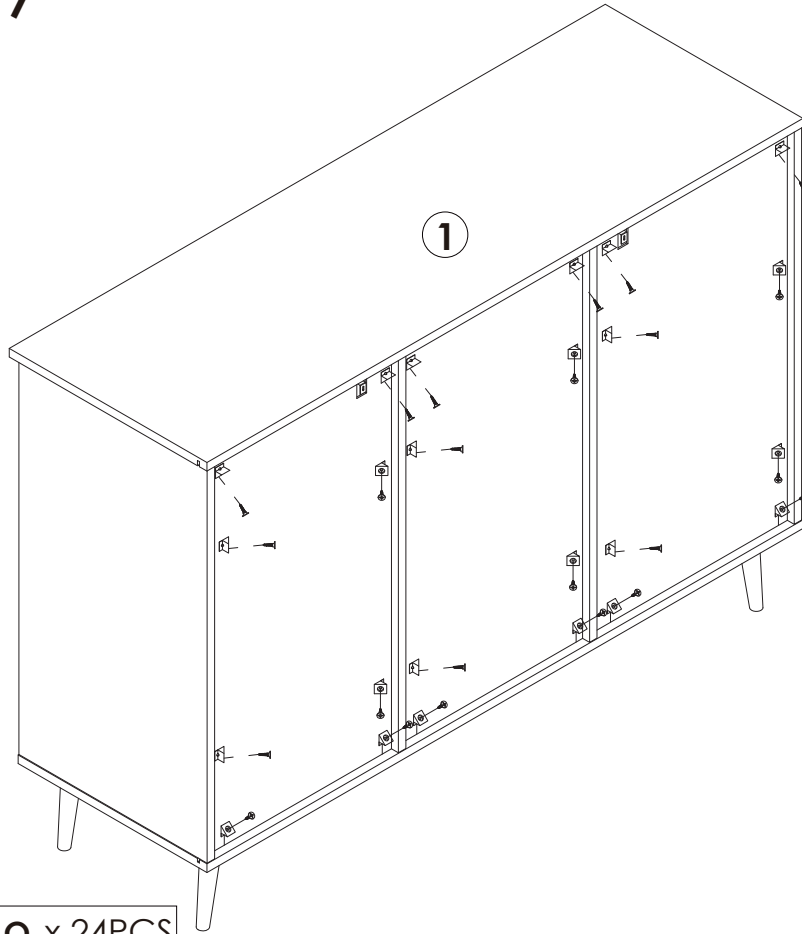

O x 24PCS



J x 24PCS

STEP 18

Drill 2 holes on the wall at the required position for anti-falling device installation.

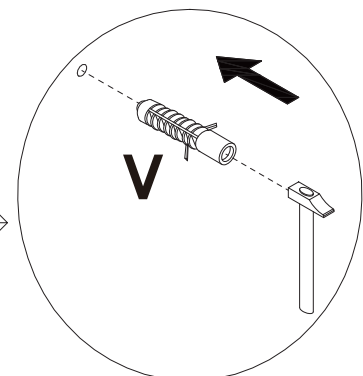
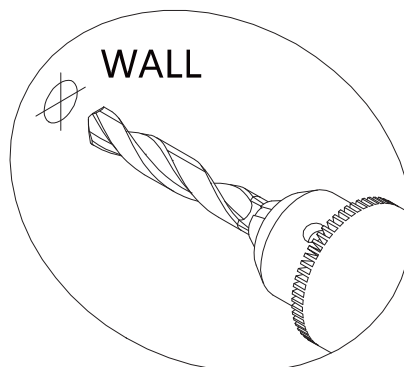
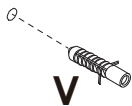
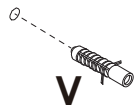
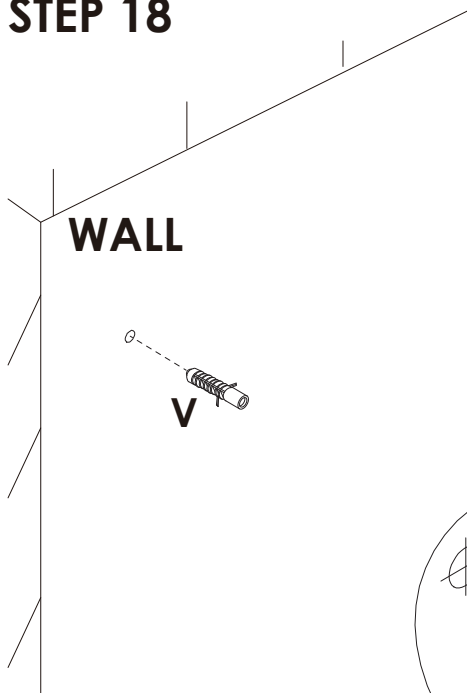

V x 2PCS

Assembly Steps(EN) / Montageschritte(DE)

STEP 19

Move the cabinet to the required position, use the "R" long screw to fix the cabinet to the wall.

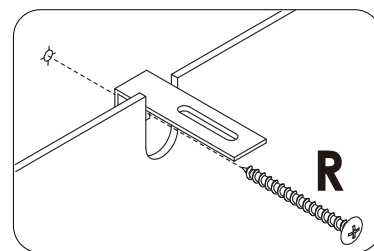
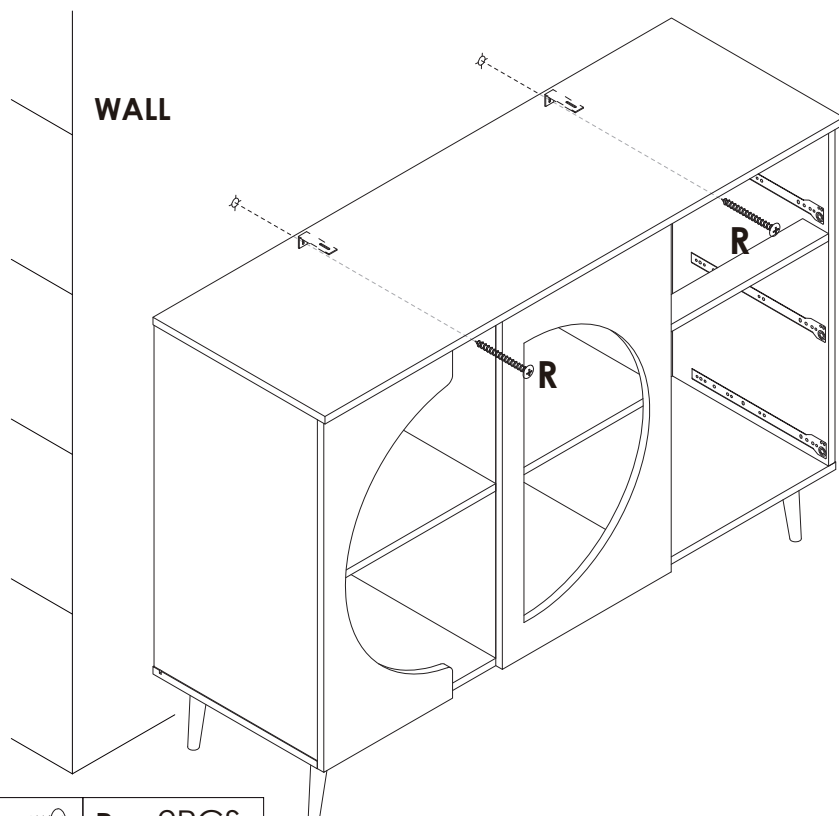

 R x 2PCS

STEP 20

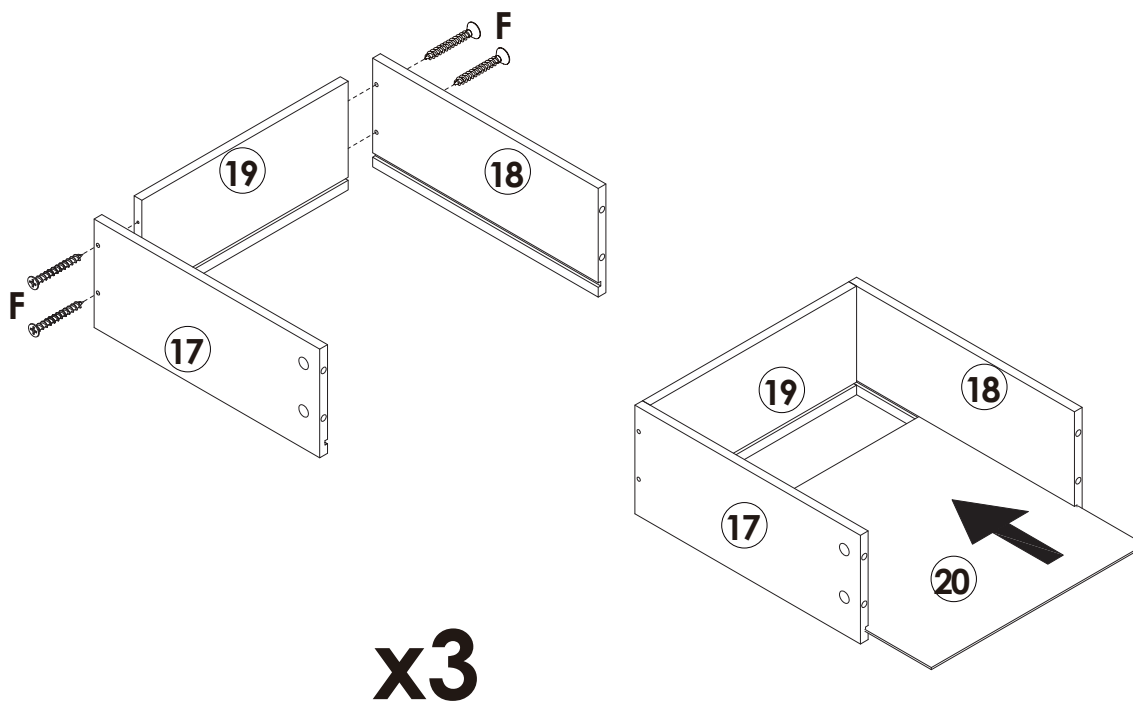



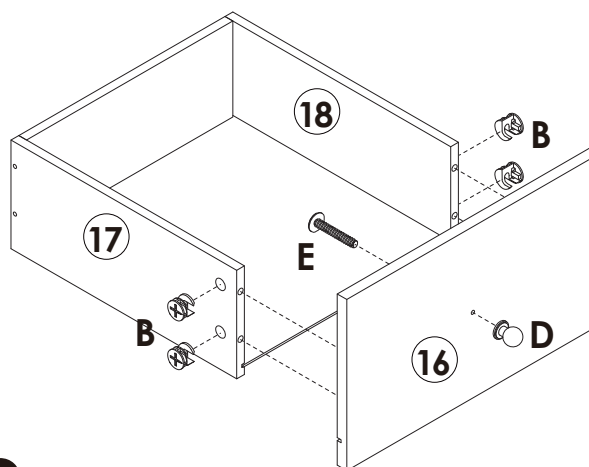
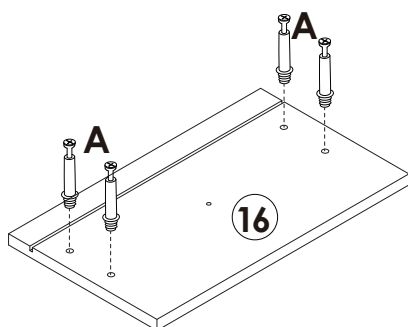

 F x 12PCS

Assembly Steps(EN) / Montageschritte(DE)

STEP 21

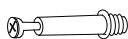

x3

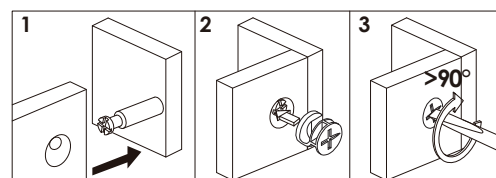

	A x 12PCS
	B x 12PCS
	D x 3PCS
	E x 3PCS

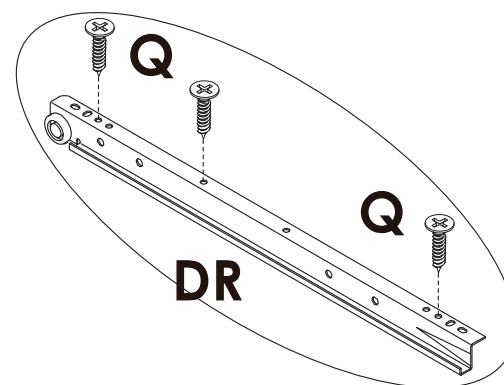
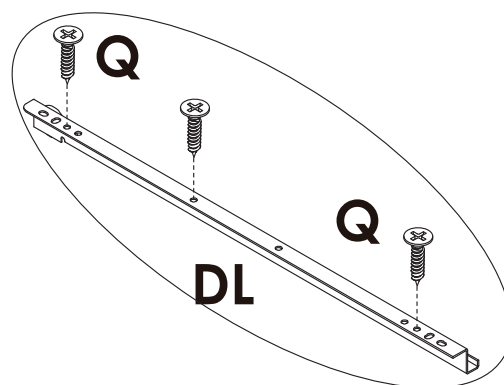
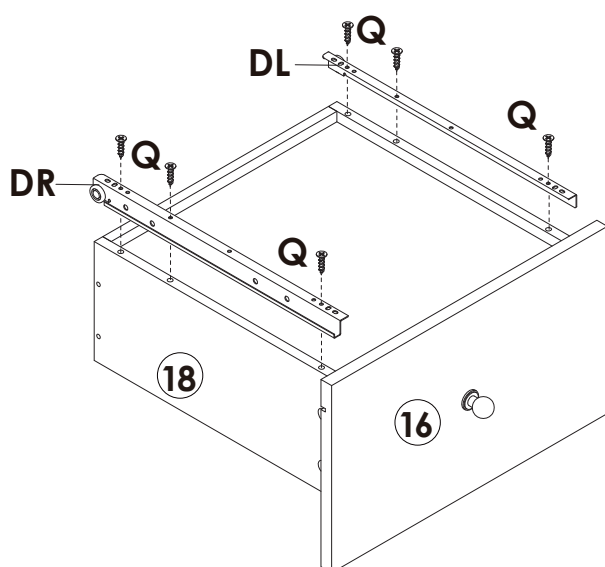

STEP 22



x3

	Q x 18PCS
	DL x 3PCS
	DR x 3PCS

Assembly Steps(EN) / Montageschritte(DE)

STEP 23

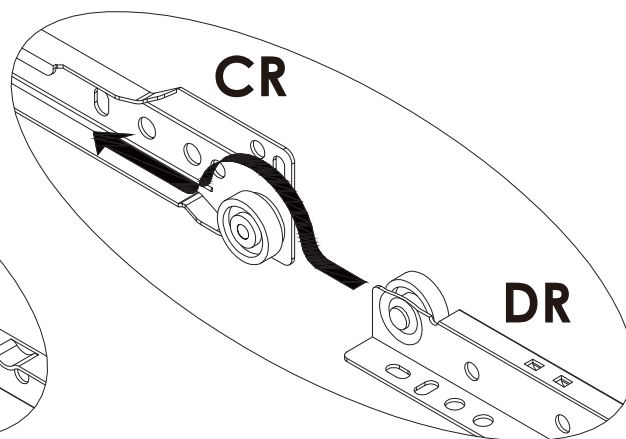
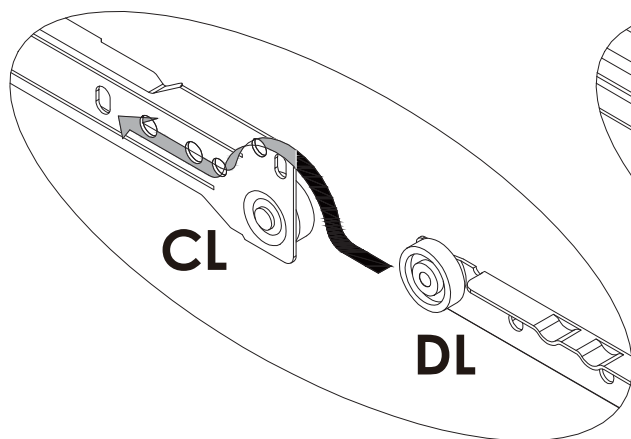
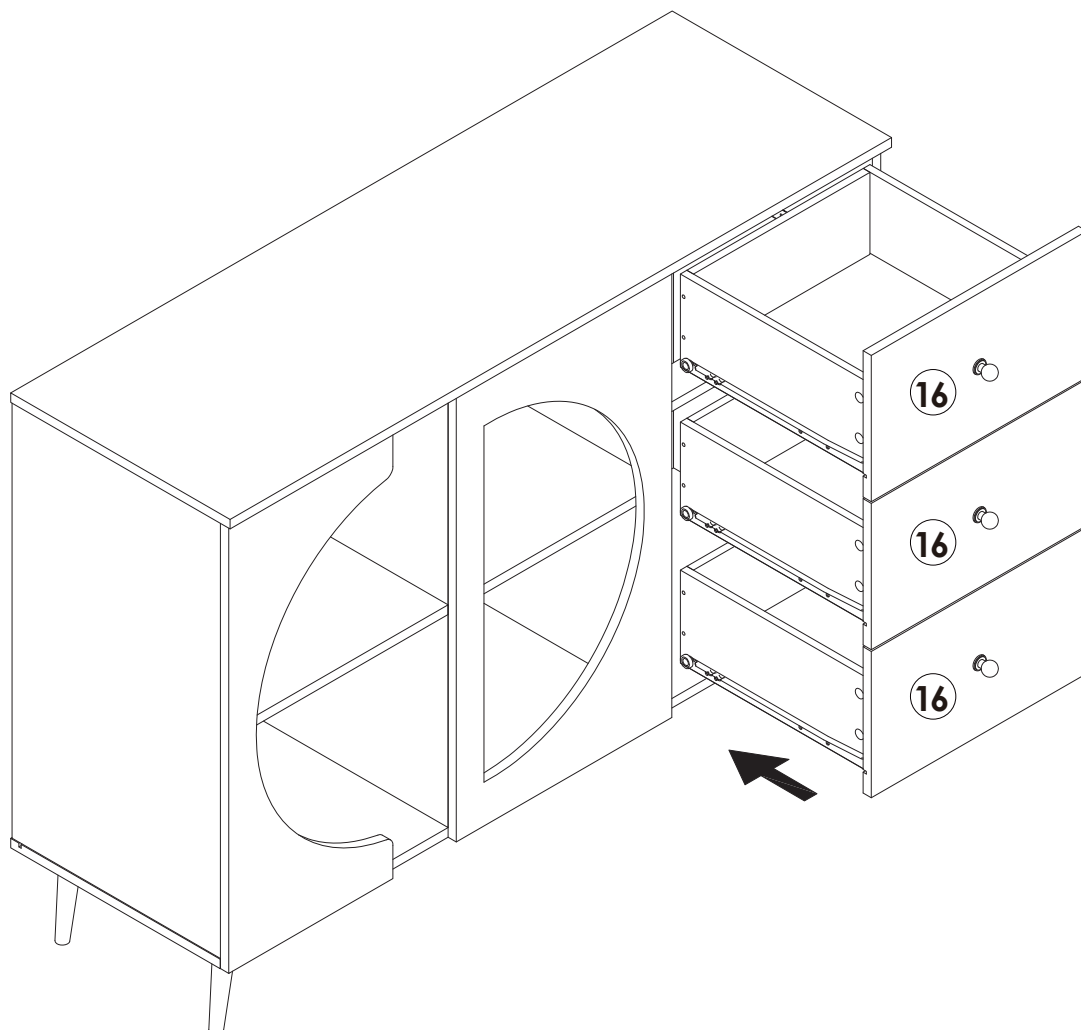

The ways to adjust the door

- Before adjusting the hinge, please check whether the cabinet is skewed.
- If the skew can not be repaired, please remove the anti-tipping device first, then adjust the cabinet to vertical position.
- Please adjust the hinge with the door open.
- Please operate it with more than 2 people, one person holds the door and the other one adjusts the screw.

Components Name

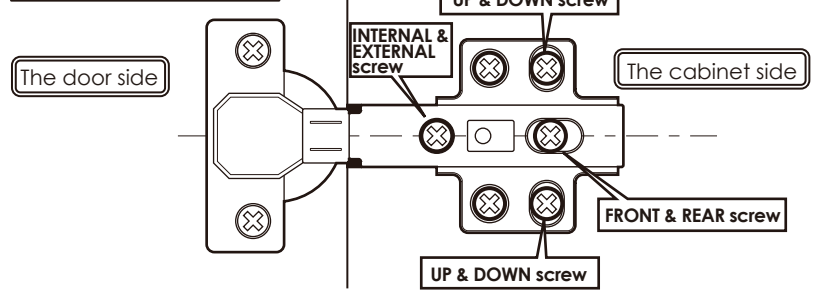

Obvious gaps between doors or Doors don't look closed

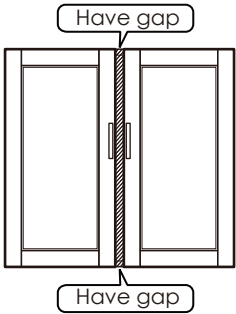

- 1 Turn "internal & external screw" to the right can make the door approach inside. Please adjust the doors little by little.

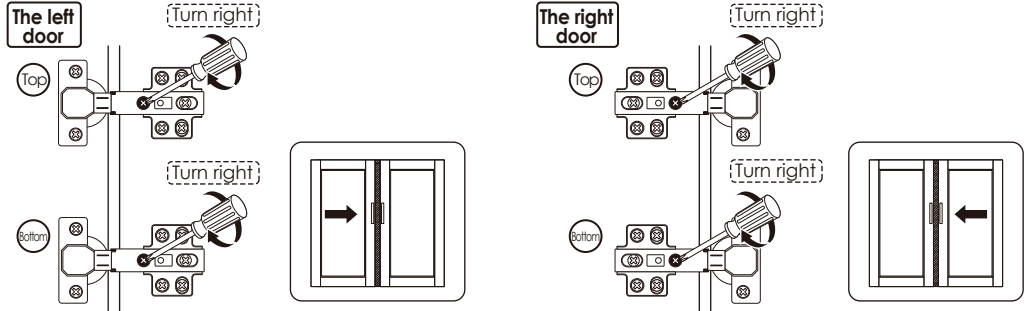

※ If the 2 doors are overlap, please turn the "internal & external screw" to the left.

When door is crooked



Please take the following steps to adjust first.

- 1 Rotate the "front and rear screws" to the left

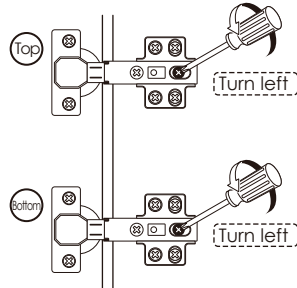

※ After adjusting the "front and rear screw", the door still does not change, please turn the "internal & external screw" to the right slightly.

- 2 Push the door to the cabinet

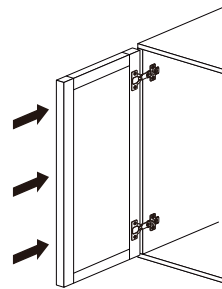

- 3 Rotate the "front and rear screws" to the right

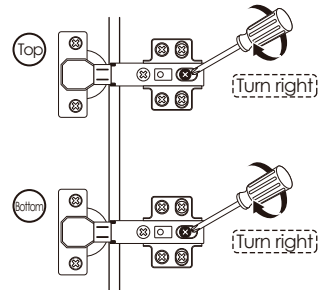

When door is leaning

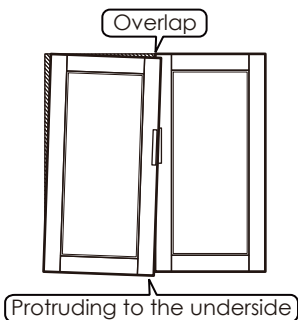

- 1 Turn "internal & external screw" to the left can make the top of the door tilted outward.

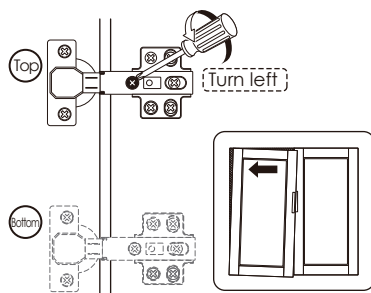

Protruding to the upside

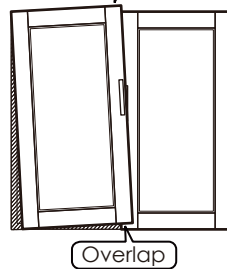

- 1 Turn "internal & external screw" to the left can make the bottom of the door tilted outward.

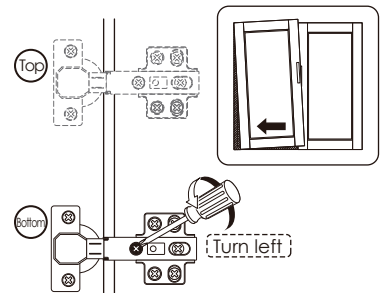

When the door is higher on top

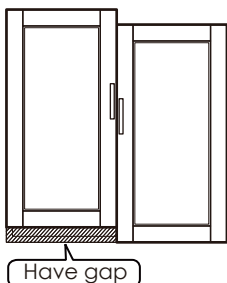

- 1 Turn "up & down screw" to the left

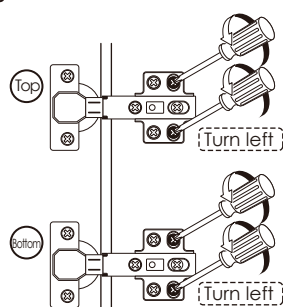

- 2 Lower the door's height so that 2 doors are of the same height.

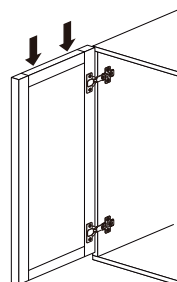

- 3 Turn "up & down screw" to the right

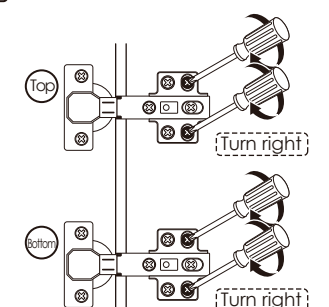

※ If the door is lower on bottom, please lift up the left door slightly on step 2



WARNING



Children have died from furniture tipover. To reduce the risk of furniture tipover:

- **ALWAYS** install Anti-tip device provided.
- **NEVER** put a TV on this product.
- **NEVER** allow children to stand, climb or hang on any drawers, doors, or shelves.
- **NEVER** open more than one drawer at a time.
- Place heaviest items in the lowest drawers.



***This is a permanent label.
Do not remove!***