

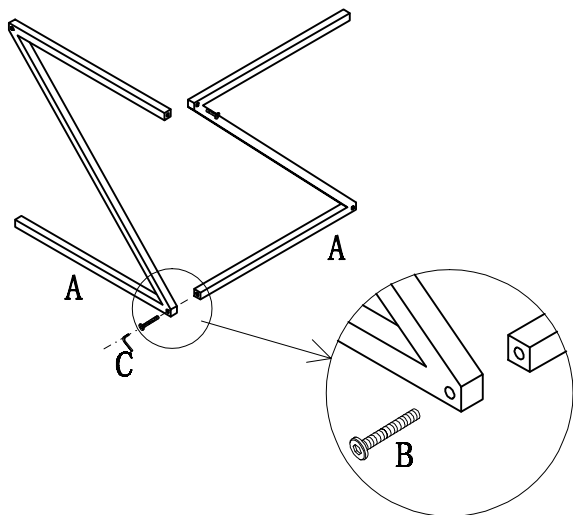

ASSEMBLY INSTRUCTIONS

1





A X 2

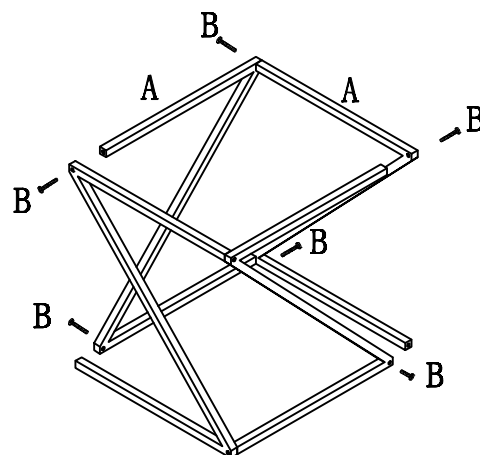

B X 2
6x30mm

C X 1

2





A X 2

B X 6
6x30mm

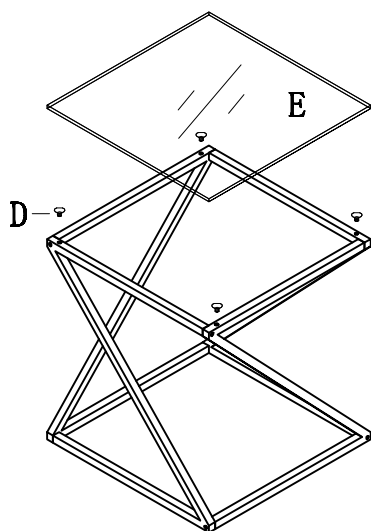
3



D X 4

E X 1

4

