

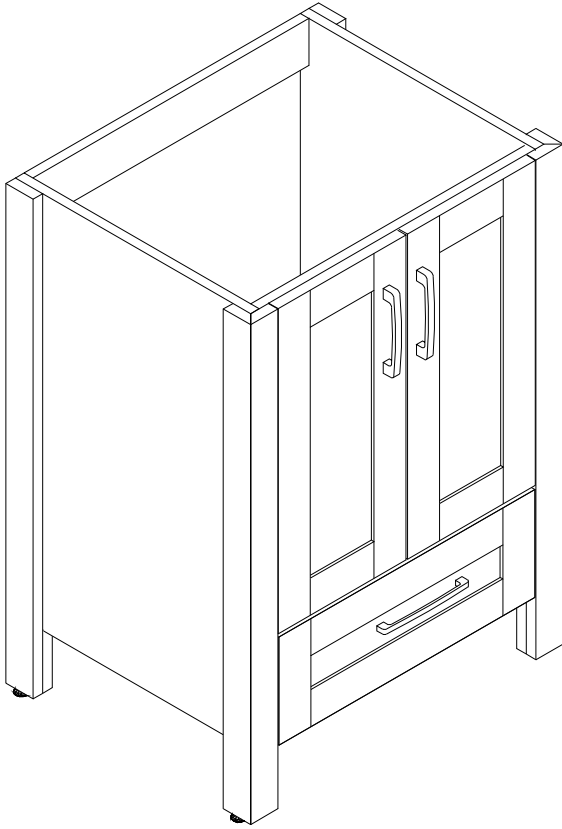













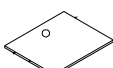



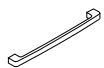

# Installation & Assembly

## DIMENSIONS

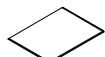

## PARTS LIST

PARTS LIST			HARDWARE LIST		
NO	DESCRIPTION	QTY	NO	DESCRIPTION	QTY
①		1	A		20
②		1	B		20
③		1	C		20
④		1	D		12
⑤		1	E		4
⑥		1	F		36
⑦		1	G		6
⑧		1	H		3
⑨		1	I		2
⑩		1			
⑪		1			
⑫		1			
⑬		1			

## ASSEMBLY DIAGRAM

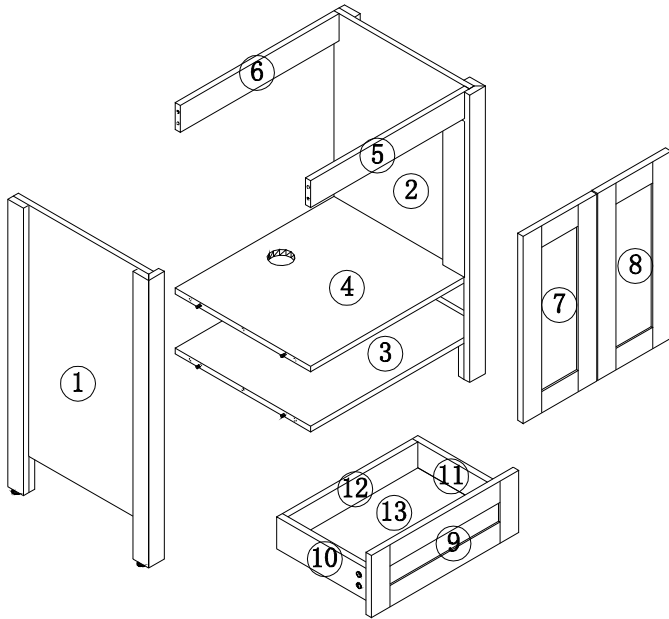

CAUTION: Please confirm the parts list before installation

YOU MAY NEED (NOT SUPPLIED)

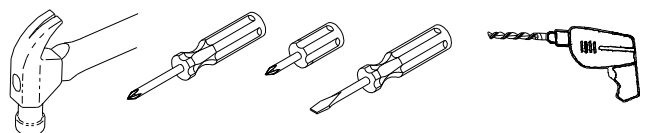

# INSTALLATIONS

## STEP 1

### HARDWARE LIST

B  20PCS

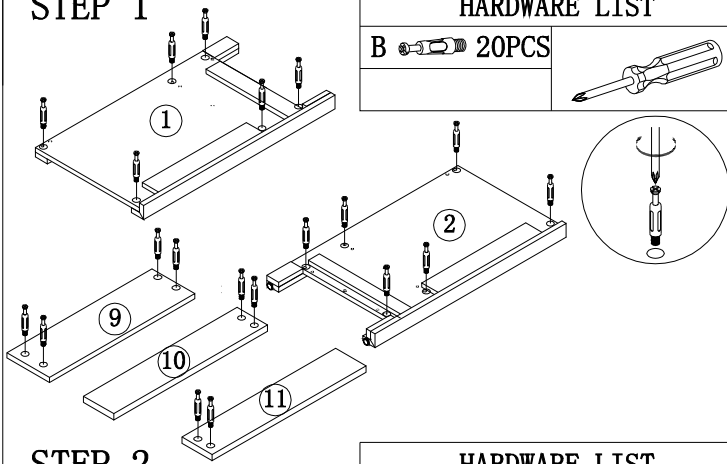
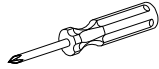

## STEP 2

### HARDWARE LIST

D  12PCS

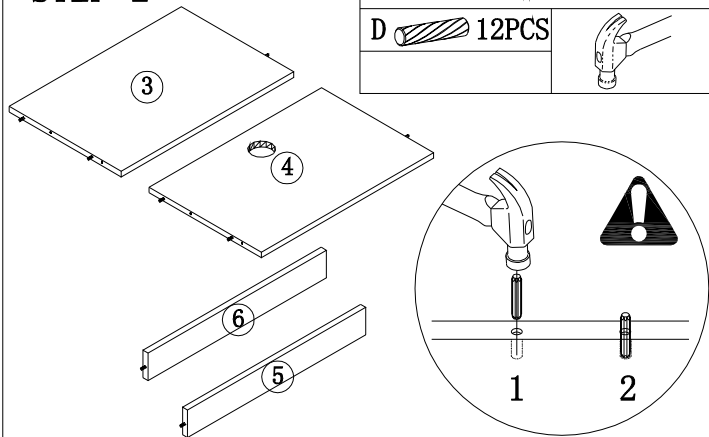
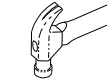

## STEP 3

### HARDWARE LIST

I  2PCS

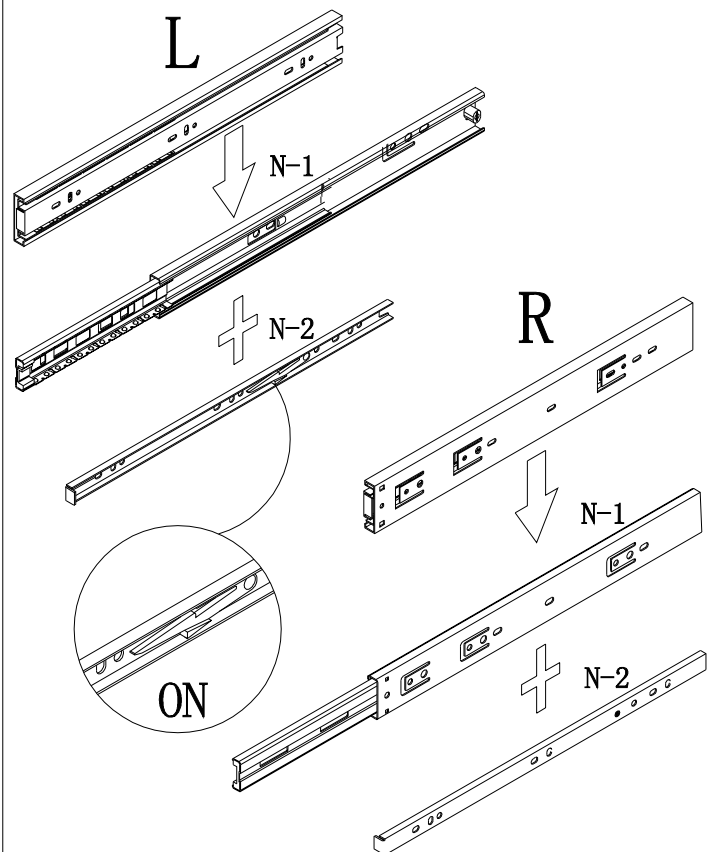

## STEP 4

### HARDWARE LIST

F  6PCS

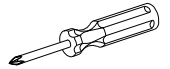

 4PCS N-1

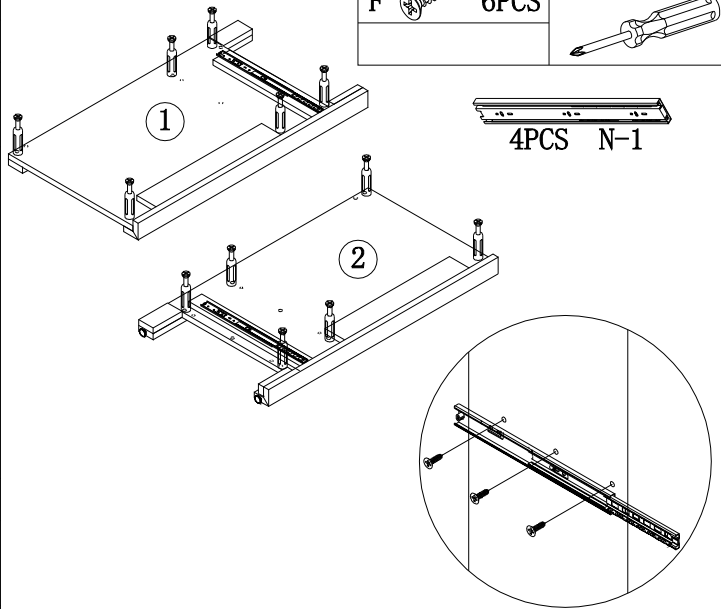

## STEP 5

### HARDWARE LIST

A  6PCS

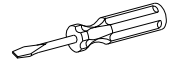

C  6PCS

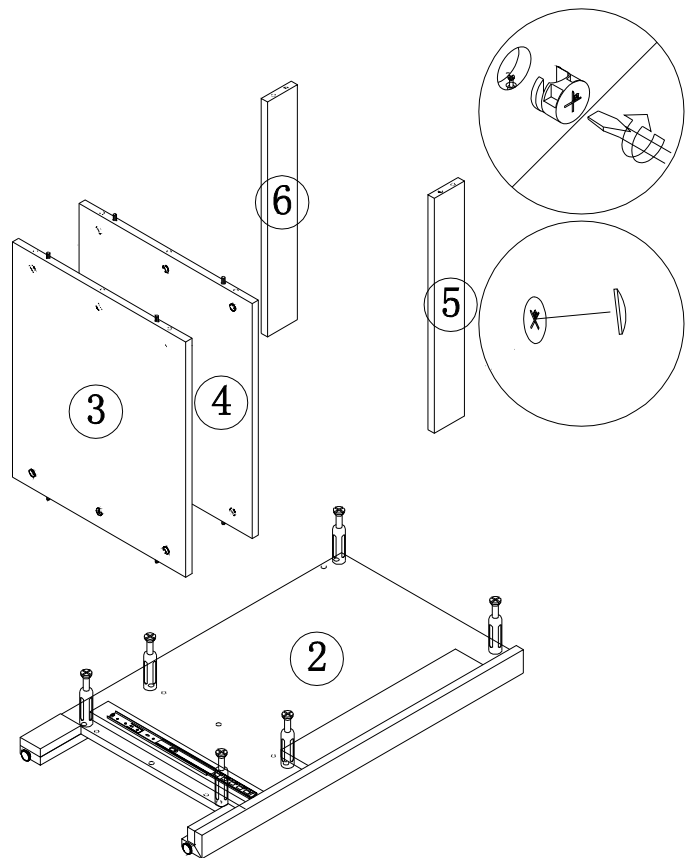

**STEP 6**

**HARDWARE LIST**

A		6PCS
C		6PCS

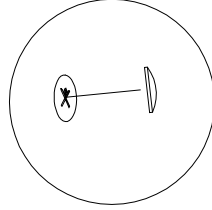
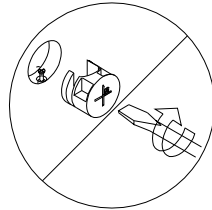
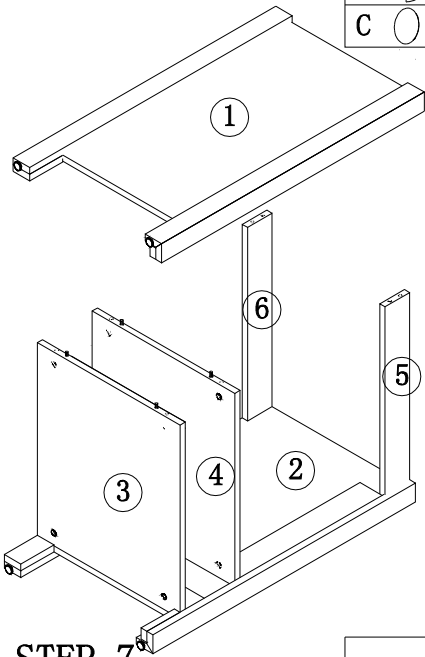
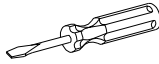



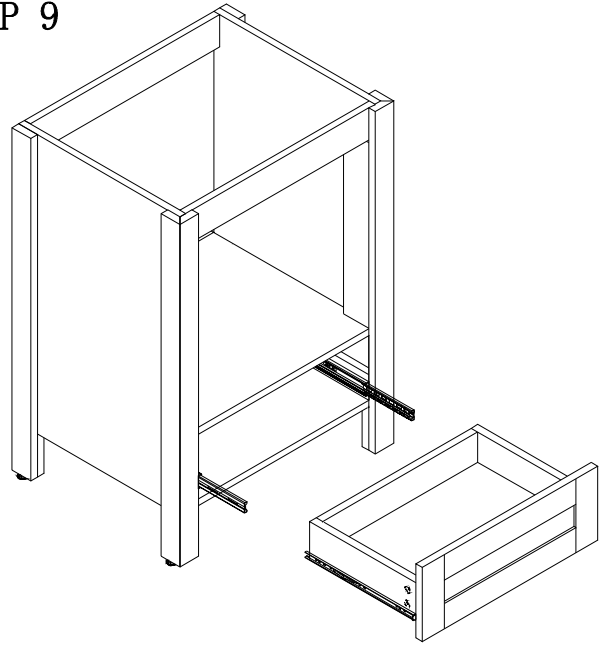

**STEP 9**



**STEP 10**

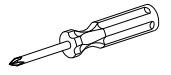

**HARDWARE LIST**

F		24PCS
H		2PCS
G		4PCS
E		4PCS



**STEP 7**

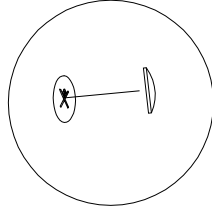
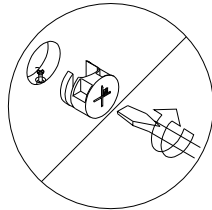
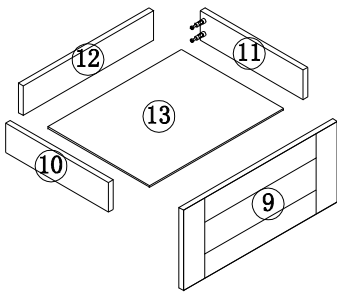
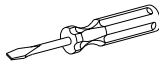

**HARDWARE LIST**

A		8PCS
C		8PCS



**STEP 8**

**HARDWARE LIST**

F		6PCS
G		2PCS
H		1PCS

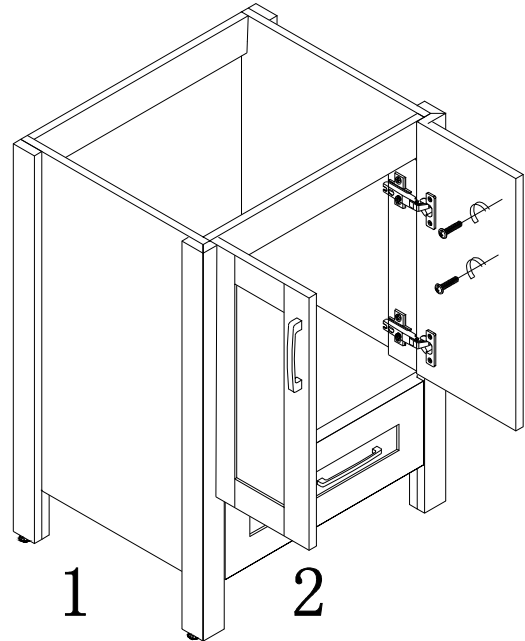
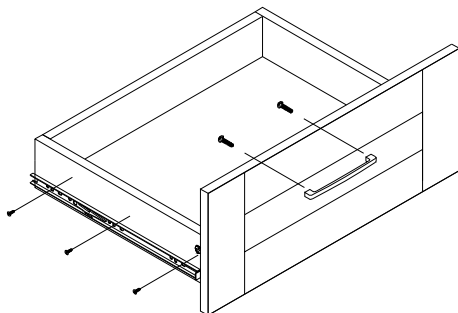
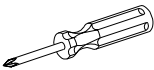

1

2

3

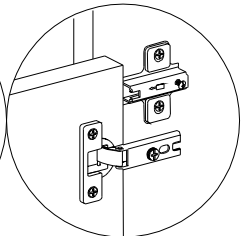
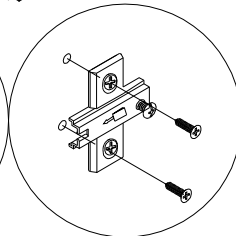
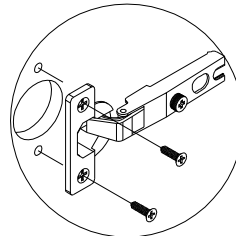

4

5

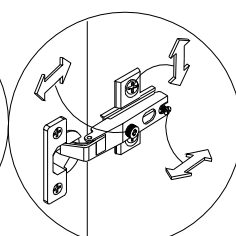
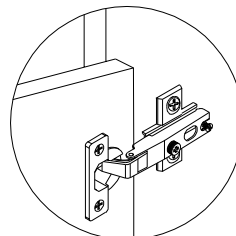

STEP 11

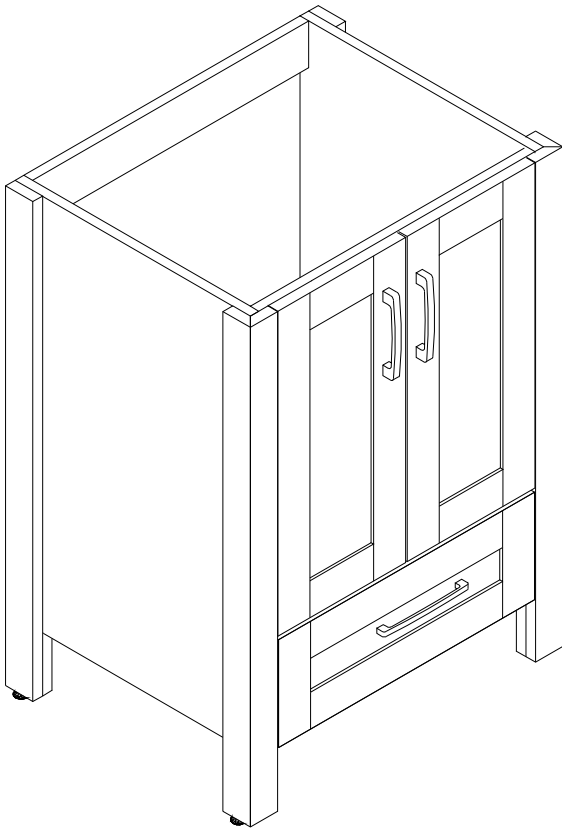

**Choking hazard-Small Parts :** This unit contains small parts, not for children under 3 years.

**Tip-over hazard :** Secure finished unit to wall stud using L-Bracket and wall screw (#10\*1.5"W/out provided). If a wall stud is

not neccessible ,Consault your local hardware store for appropriate mounting hardware . Failure to properly install will result in product collapse or tip-over. Serious injury can occur .