

Jewenwils

Floor Lamp

[Instruction Manual]

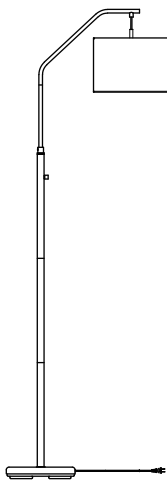





Please pay attention to the warning signs
Read the instructions with caution before operating
and keep it properly



CAUTION

1. Before assembly, place all parts out on a clean flat surface and inspect each part for defects that may have occurred during shipping.
2. Inspect wire insulation for any cuts, abrasions or exposed copper that may have resulted during shipping. If there are any defects in the wire, DO NOT continue to assemble. Please send an email to our Customer Service immediately.
3. Consult a qualified electrician if you have any electrical questions.
4. Never drape clothes over the lamp.
5. To reduce the likelihood of tipping over, we recommend don't place the lamp at the edge of table and keep children and pets away.
6. To prevent children from suffocating and choking, keep them away from packing materials.
7. Please keep this manual and hand it over when you transfer the product.

Packing List

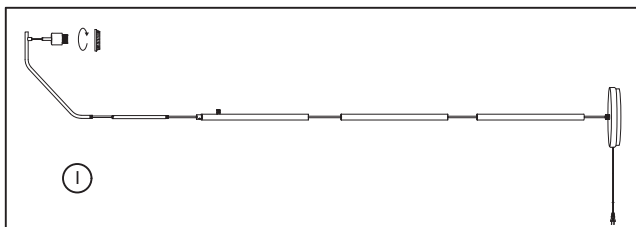
Part Number	Part Drawing	Part Describe	Quantity
①		Shade Upper Metal Ring	1
②		Shade Lower Metal Ring	1
③		Colth Shade	1
Ⓜ		Lamp holder Ring	2(1 backup)



<p>(J)</p>		<p>Spanner</p>	<p>1</p>
<p>(K)</p>		<p>Dimmable LED Bulb (10w 3000K)</p>	<p>1</p>
<p>(L)</p>		<p>screw</p>	<p>2 (1 backup)</p>

ASSEMBLY INSTRUCTIONS

Shade Assembly

1

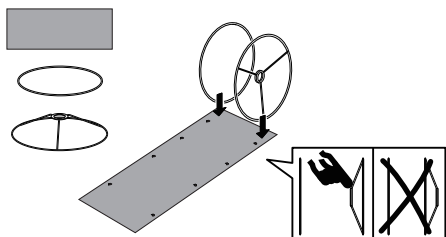

2

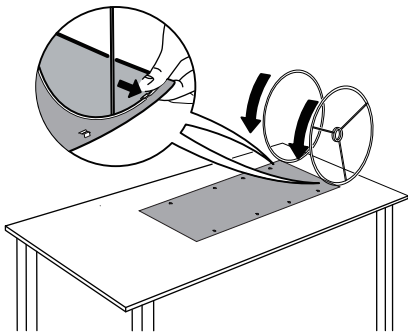

3

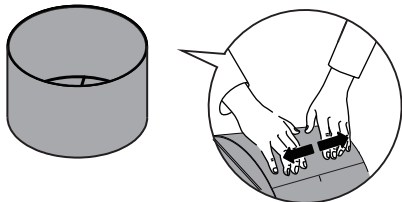

J

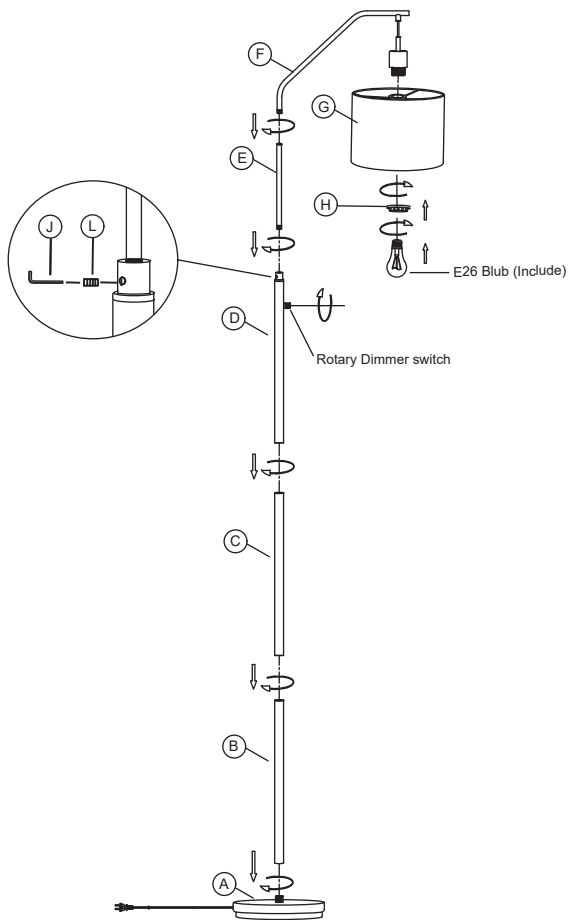

1. Screw the Tube-1 (B) clockwise onto Base (A) until tight.
 2. Screw the Tube-2 (C) clockwise onto Tube-1 (B) until tight.
 3. Pull and tighten the power cord, then screw the Tube-3 (D) clockwise onto Tube-2 (C) until tight.
 4. Screw the Tube-4 (E) clockwise onto Tube-3 (D) until tight.
 5. Screw the Tube-5 (F) clockwise onto Tube-4 (E) until tight.
 6. Align the orientation of Tube-4 (E) with the switch by rotating Tube-5 (F), then secure Tube-4 (E) with SCREW (L) by rotating the SPANNER (J) clockwise.
 7. Place the shade (G) on socket then screw on the socket ring (H) to fix the shade.
 8. Install the dimmable bulb by screwing it into the socket.
- NOTE: If you need to replace the bulb and also want to dimming, please buy Standard Medium E26 Dimmable bulbs.**

FUNCTIONS

1. Rotary Switch & Stepless Dimmable

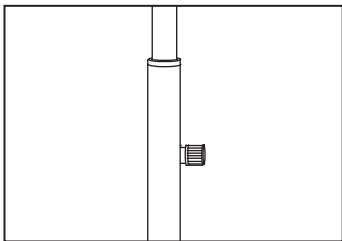

Specifications

- Product Height: 68 IN
- Base Diameter: 10.2 IN.
- Materials: Metal, Linen
- Input Voltage: 120VAC 60Hz
- Max. load Power: Incandescent Bulb 60W or LED Bulb 12W
- Socket Type: Standard Medium E26
- Dimmable Bulb: 9W 3000K

IMPORTANT SAFETY INSTRUCTIONS

This portable lamp has a polarized plug (one blade is wider than the other) as a safety feature to reduce the risk of electric shock. This plug will fit in a polarized outlet only one way. If the plug does not fit fully in the outlet, reverse the plug. If it still does not fit, contact a qualified electrician. Never use with an extension cord unless the plug can be fully inserted. Do not alter the plug.

One Year Limited Warranty

Supported by our professional R&D team and QC team, we provide One Year Warranty for materials and workmanship from the purchase date. Please note that the warranty does not cover damage caused by personal misuse or improper installation.

Please attach your Order ID and Name so that our dedicated customer service team can help you better.