

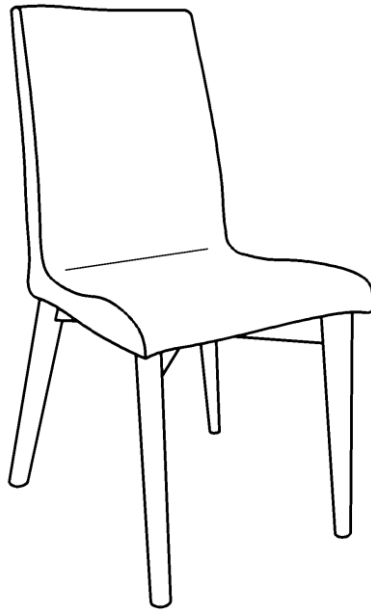

Assembly Instructions

Caution : You must read this before you proceed



DINING CHAIR

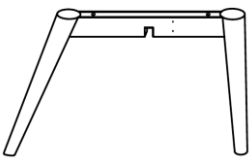
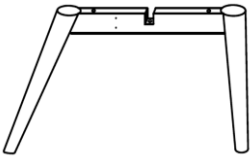

Part List

| Label | Picture | Description | QTY |
|-------|---|--------------------|-----|
| A |  | Leg - A | 1 |
| B |  | Leg - B | 1 |
| C |  | Cushion Chair Seat | 1 |
| D |  | Corner Block | 2 |

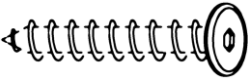
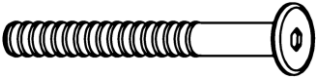
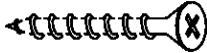
Hardware

| Label | Picture | Description | QTY |
|-------|--|---------------------------|-----|
| ① |  | JCBC W Screw M7 x 40mm | 1 |
| ② |  | JCBC Screw M6 x 60mm | 4 |
| ③ |  | FH Screw #8 x 25mm | 8 |
| ④ |  | Allen Key M4 | 1 |

Assembly Preparation

Before Beginning Assembly:

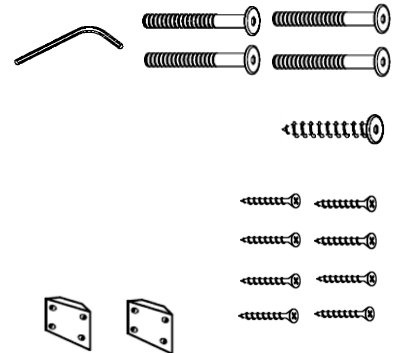
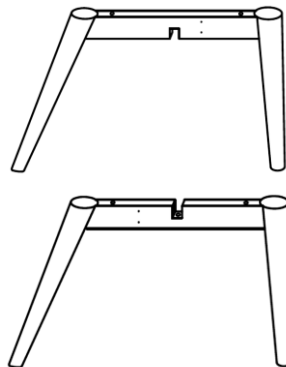
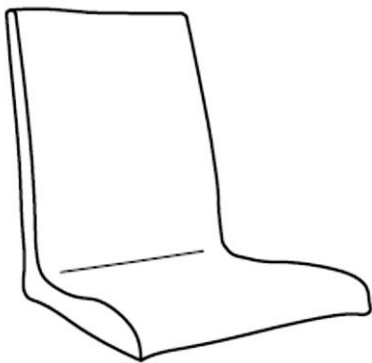

- Read instructions, cover to cover-



- Have 2 adults on hand for assembly-



- Do not assemble on flooring or carpet-



- Assemble on a clean non-marring surface (packing foam)-



- Save all packaging until finished-

Assembly Steps

Overview

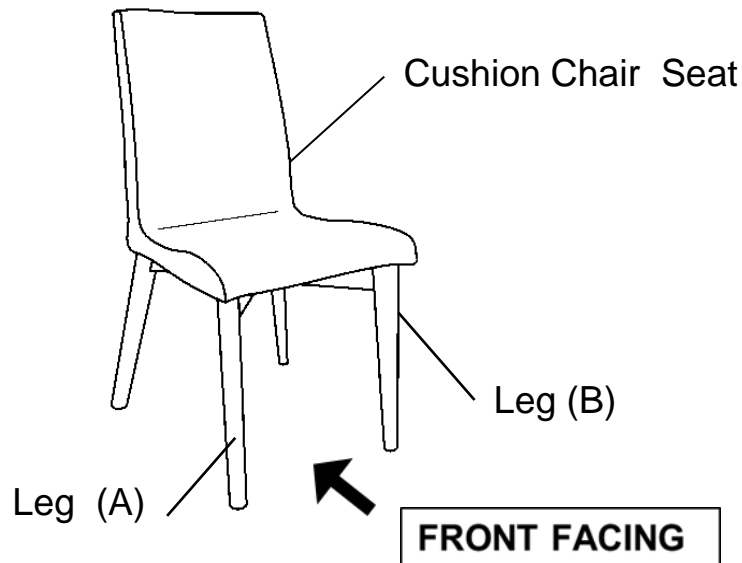

This Dining Chair has multiple parts and may require up to some 30 minutes to assemble. To give you an overview of the Dining Chair parts, the above picture is to help you put the various parts into perspective. Please read through the instructions below to familiarise yourself with the parts and steps before assembly.

Step 1

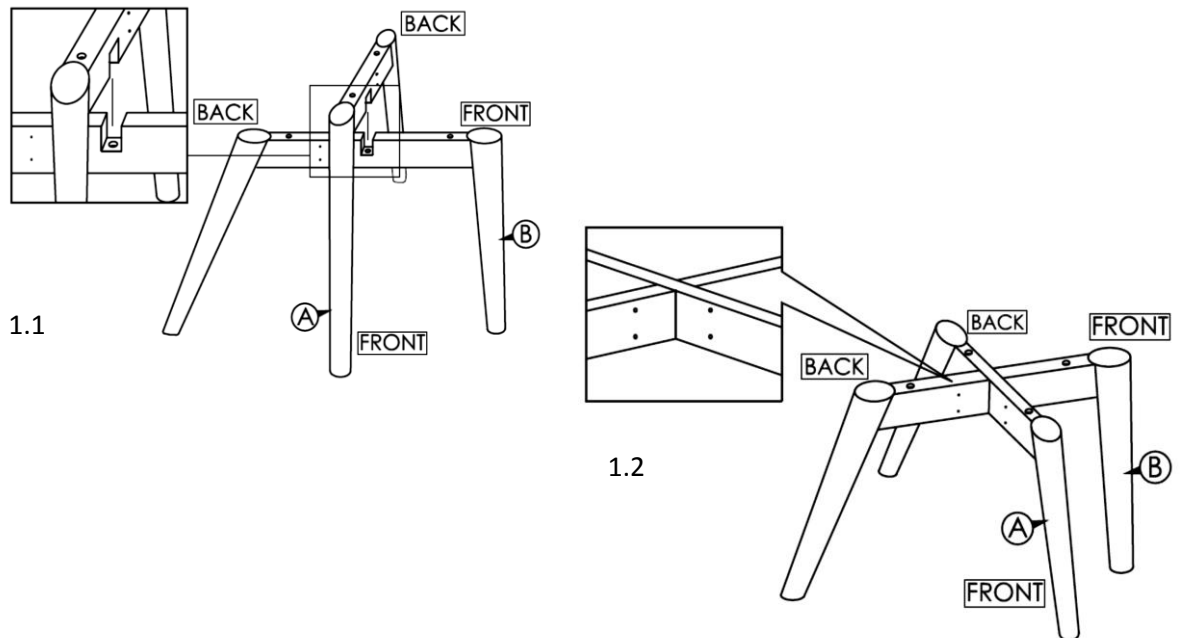

1.1 Crossover the Leg Up (A) and Leg Down (B) as shown. Make sure the leg right position front and back.

1.2 Make sure the mounting position to be one side as picture shown. Shold not be in different side before assembly

Step 2

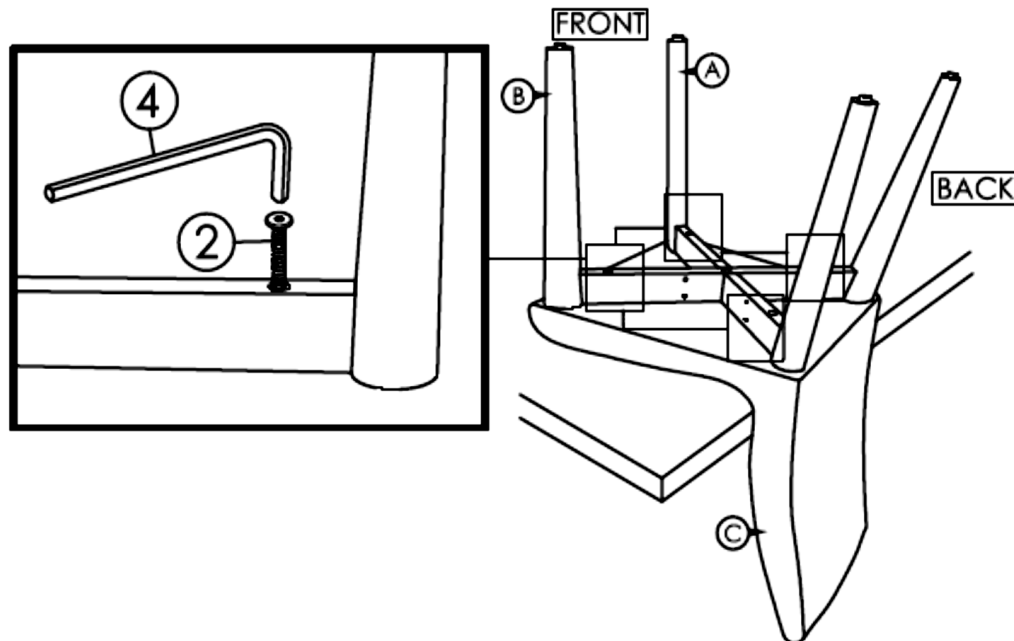

Place the Cushion Chair Seat (C) on the table as shown for easy assembly, and place the assembled part that finished in Step 1 on the cushion seat. Then, fix the Leg with JCBC Bolt ② using Allen Key ④.
DO NOT FULLY TIGHTEN BOLT.

Step 3

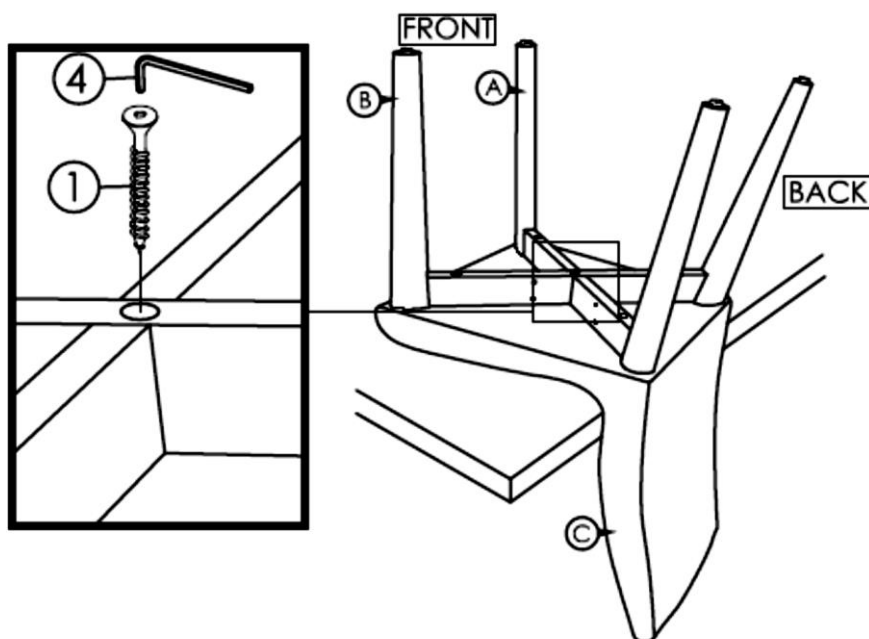

Fix the Leg with JCBC W Bolt ① using Allen Key ④ at center of the assembled part
DO NOT FULLY TIGHTEN BOLT.

Step 4

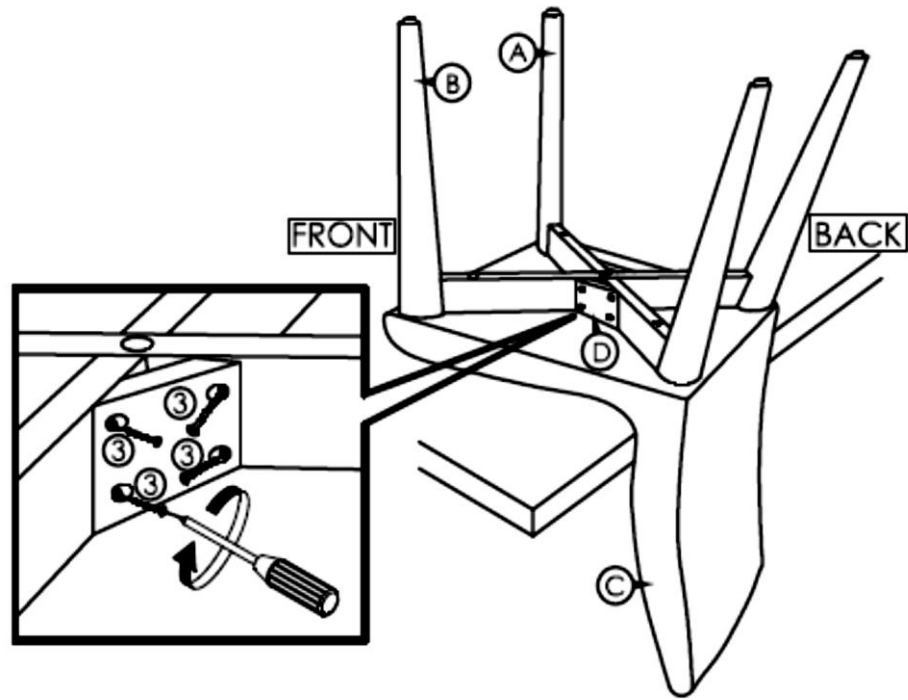

Place the Corner Block (D) at the center leg as shown.
Then, fix the Corner Block (D) with Screws ③ using Screwdriver (not provided). Repeat the step for another Corner Block.
DO NOT FULLY TIGHTEN THE BOLT AND SCREWS NOW.

Step 5

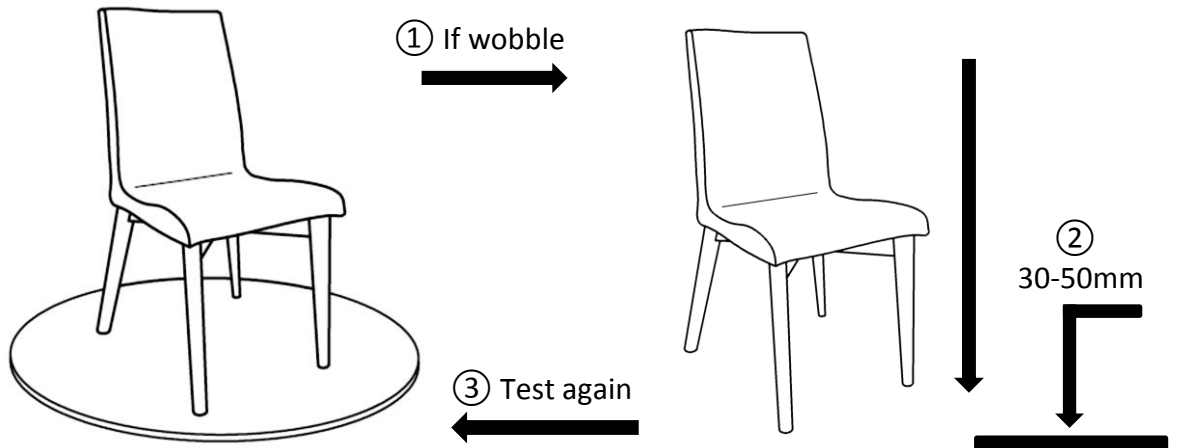

Place the dining chair on a Level Surface to check if it wobbles.
If it wobbles, lift the dining chair some 30cm to 50cm high from the ground, keep your feet and toes well away from the drop zone, and drop the dining chair freely and vertically with the four legs, hitting the ground at the same time.

This Drop Test will help to ensure that all the bolts and gaps to all reach full alignment.

Test again for evenness on Level Surface.

If no wobbles are found, proceed to tighten all the Bolts.

Caution: When tightening the Bolts, tighten sequentially.

Do not tighten any screw fully and then towards the next one, this would cause the frame to warp. If it still wobbles, loosen the bolts and execute this same drop test.

If the dining chair is not Stable it could lead to damage to the product.

Step 6























Inspect and make sure all parts are connected.

The dining chair is ready for use.

Caution: This dining chair can only be used on a flat, level surface.

Care & Maintenance

Care & Maintenance

-   ● Do not put hot items directly on furniture surface
 -   ● Do not clean furniture with harsh cleansers or polish.
 -   ● Do not place furniture under direct sunlight.
 -   ● Do not place furniture near heating or cooling vents.
 -   ● Do not write on furniture without a padded barrier to protect the surface.
 -   ● Do not place furniture outside . For indoor use only .
 -   ● Not for commercial use. For residential use only .
 -   ● Stains may be removed with mild soap solution and damp cloth.
 -   ● Children should not climb or jump on the furniture.
-
-   ● Dust and pick-up spills using a clean, non-colored, lint-free cloth .

What is Proposition 65?

Proposition 65 is a California law that requires warning labels on products that may contain one of more than 800-plus chemicals or ingredients that the California Office of Environmental Health Hazard Assessment (OEHHA) has deemed to cause cancer or other reproductive toxicity. Chemicals and elements on this list include wood dust, brass, and other everyday substances, which can be found in very common household items, such as: lamps, tableware, jewelry, crystal glasses, electric cords, beauty products, automobiles, and furniture.

Why Did I Find a Proposition 65 Warning on My Home Goods Product?

We include Proposition 65 warnings on all of our products because there is always a chance that one of the 800-plus common chemicals and ingredients listed under this law could potentially be on our furniture or packing materials. We risk large fines under this law, if we don't include this warning.

Should I worry?

We realize you may be worried finding this warning on our products, but we want to reassure you that the hazardous exposure limits for any of these chemicals have never been found on furniture products that we've shipped to our customers. Additionally, this warning label is very common and can be found on almost every piece of furniture sold in the state of California.

Just How Common Are Proposition 65 Warnings?

Proposition 65 warnings have become so common in California that it is hard to take a trip to a local bank, grocery store, or restaurant without finding at least one warning. In fact, even the Disney Land Resort has a Proposition 65 warning:

