

ASSEMBLY INSTRUCTION

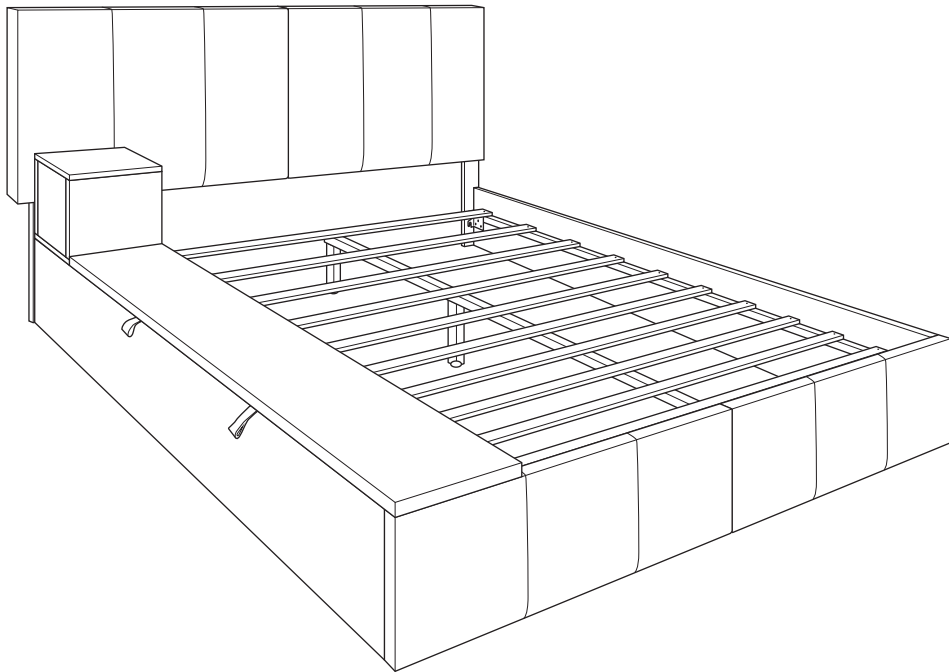

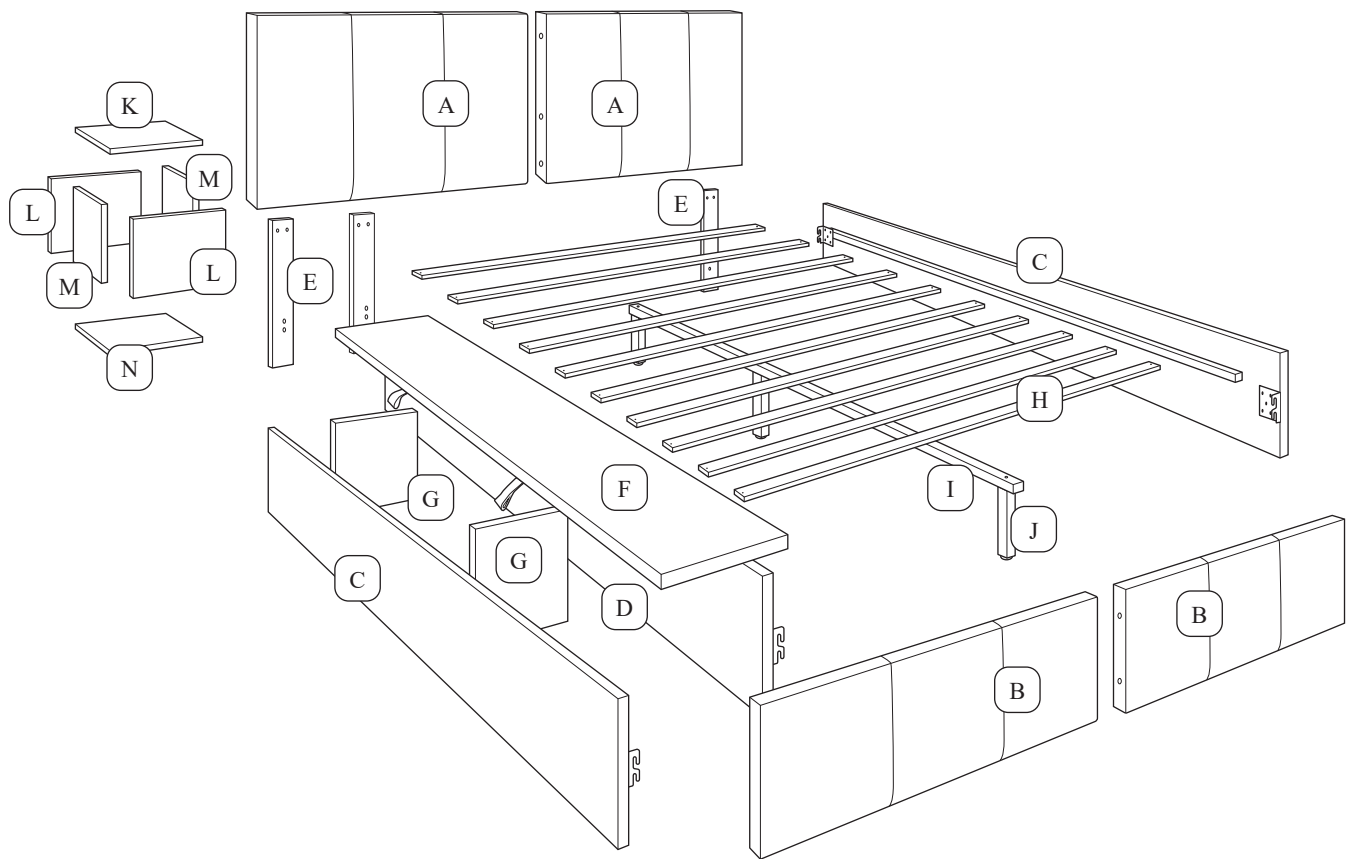

SKU CODE : WF318118 / WF318119
ITEM : UPHOLSTERED BED (QUEEN)



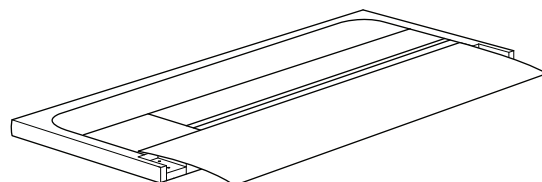

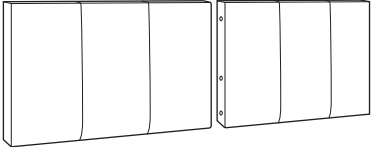
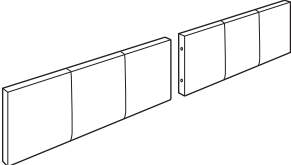
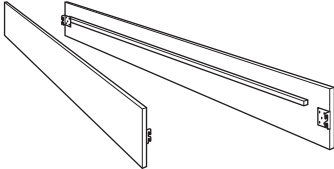
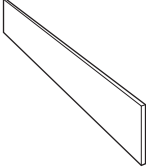

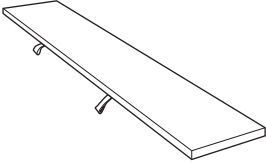
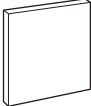
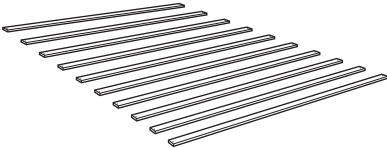
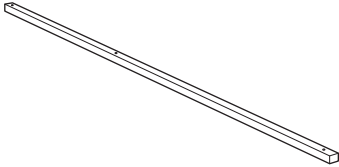



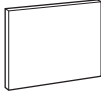









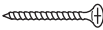





Bed Parts are shipped inside a compartment
in the back of the headboard.

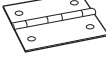

NO	PART LIST	QTY
A	Headboard 	2 pcs
B	Footboard 	2 pcs
C	Side Rail 	2 pcs
D	Center Side Rail 	1 pc
E	Headboard Leg 	3 pcs
F	Top Side box 	1 pc
G	Center Side box 	2 pcs
H	Bed Slat 	1 Set
I	Bed Center Rail 	1 pc
J	Bed Center Rail Support 	3 pcs

NO	PART LIST		QTY
K	Small Box Top		1 pc
L	Small Box Side i		2 pcs
M	Small Box Side ii		2 pcs
N	Small Box Bottom		1 pc

NO	PART LIST		QTY
1	JCBB Bolt M8 x 20 mm		12 pcs
2	JCBB Bolt M8 x 35 mm		6 pcs
3	JCBC Bolt M6 x 70 mm		3 pcs
4	JCBB Bolt M6 x 35 mm		5 pcs
5	JCBC Bolt M6 x 16 mm		32 pcs
6	CSK Screw M4 x 30 mm		20 pcs
7	CSK Screw M4 x 20 mm		14 pcs
8	CSK Screw M4 x 16 mm		8 pcs

NO	PART LIST		QTY
9	CSK Screw M4 x 12 mm		10 pcs
10	Spring Washer M8		6 pcs
11	Flat Washer M8		6 pcs
12	Spring Washer M6		5 pcs
13	Flat Washer M6		5 pcs
14	Adjuster Screw M6 x 23 mm		3 pcs
15	L-bracket (2 Hole) 20 X 20 X 18 X 1.4 mm		2 pcs
16	L-bracket With M8 Hole (2 Hole) 18 X 20 X 2 mm		16 pcs
17	Hinges 50 X 30 X 1.2 mm (4 Hole)		2 pcs
18	Allen Key M4		1 pc
19	Allen Key M5		1 pc
20	Lift Spring Hings		2 pcs



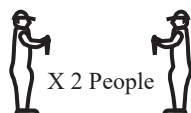

Read this instruction carefully. Remove all wrapping material, staples and straps from the carton. See hardware and furniture part list for guidance. Be sure you have all wooden furniture parts on a clean and flat surface, such as carpet or rug, to prevent from being scratched.

CAUTION :

1. Do not Full Tighten the nut or screw until all ready to assemble.
2. Do not Over Tighten the nut or screw to avoid causing damages to the thread.
3. Keep all hardware part out reach of children.





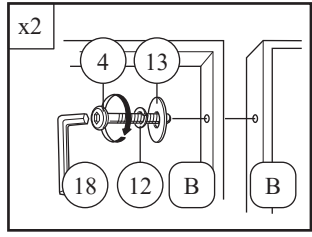
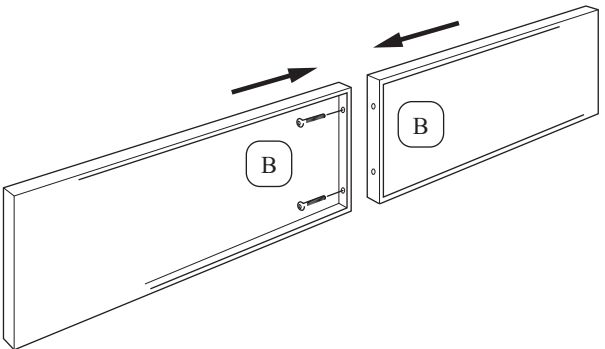
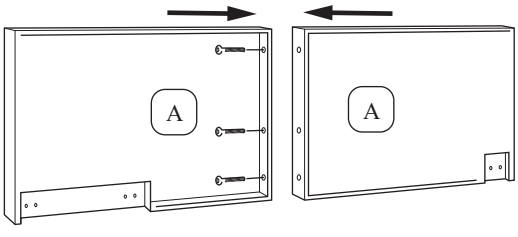
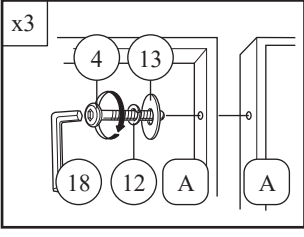

STEP 1

4	12	13	18
			
5 pcs	5 pcs	5 pcs	1 pc



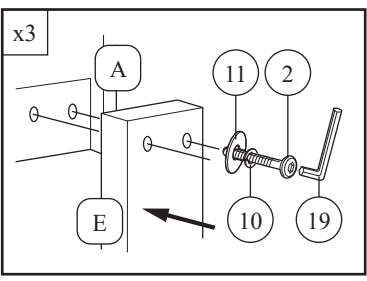
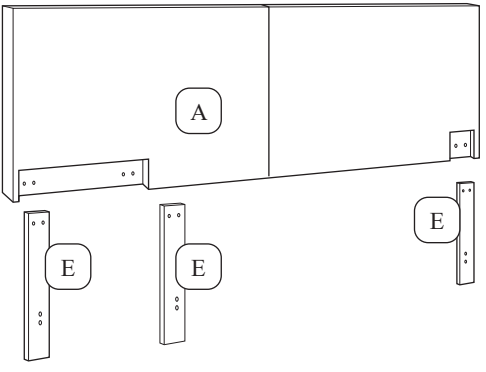

STEP 2

2	10	11	19
			
6 pcs	6 pcs	6 pcs	1 pc



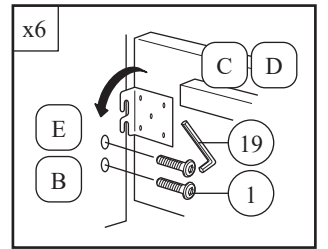
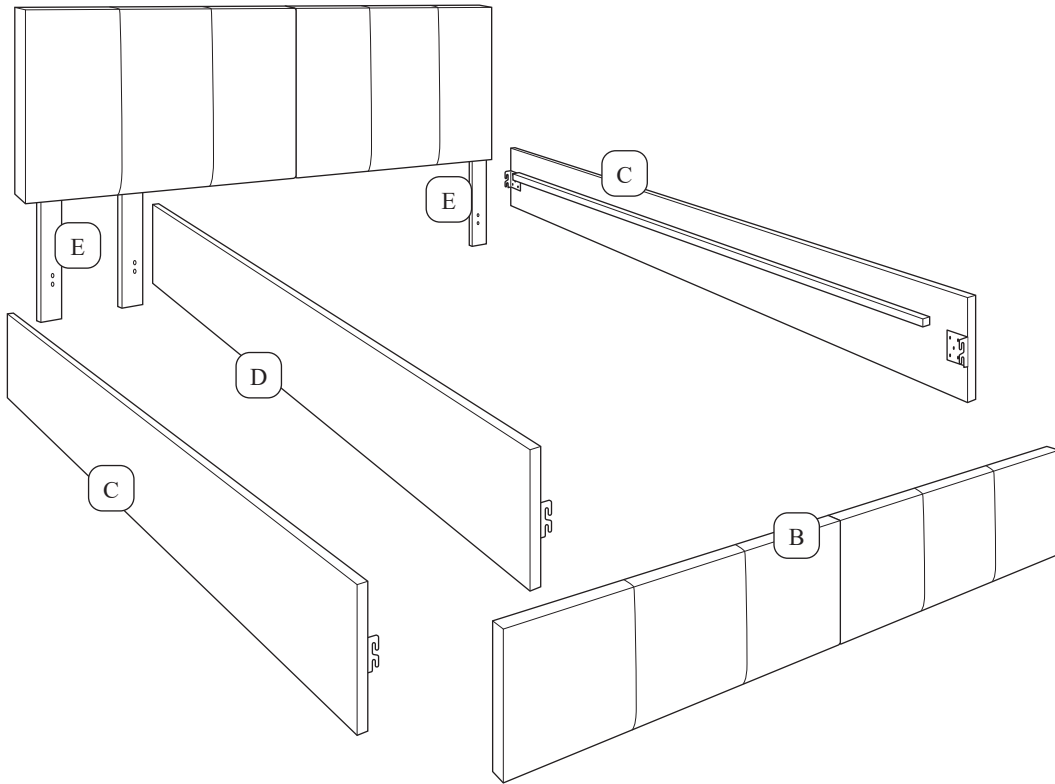

STEP 3

1	19
	
12 pcs	1 pc



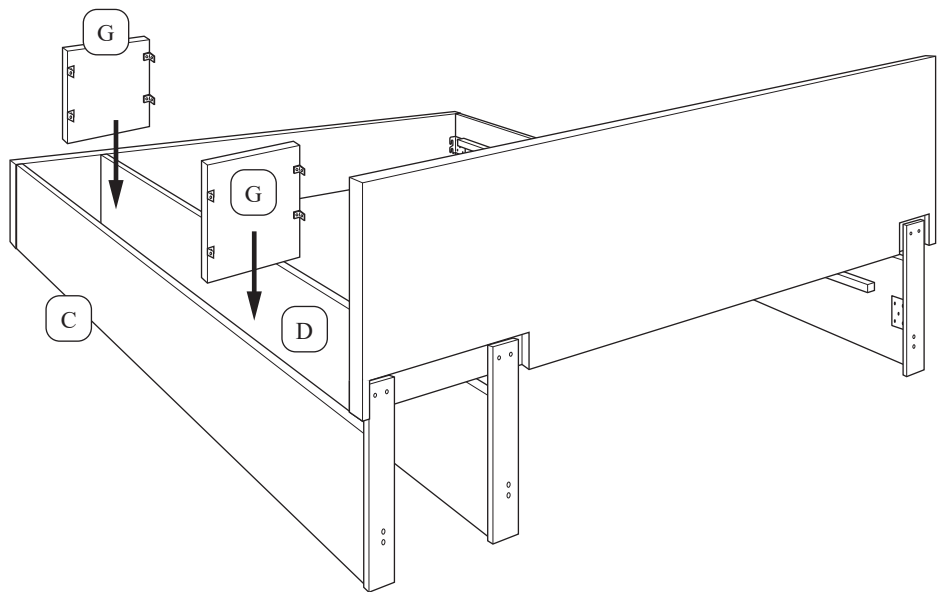
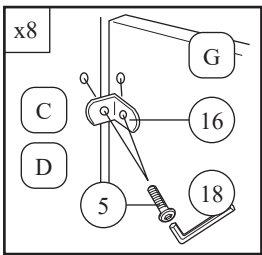

STEP 4

5	16	18
		
16 pcs	8 pcs	1 pc





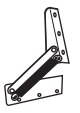

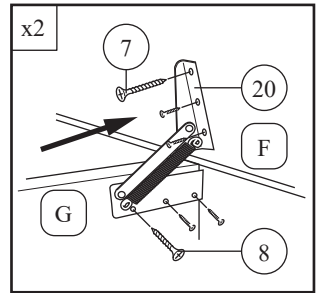
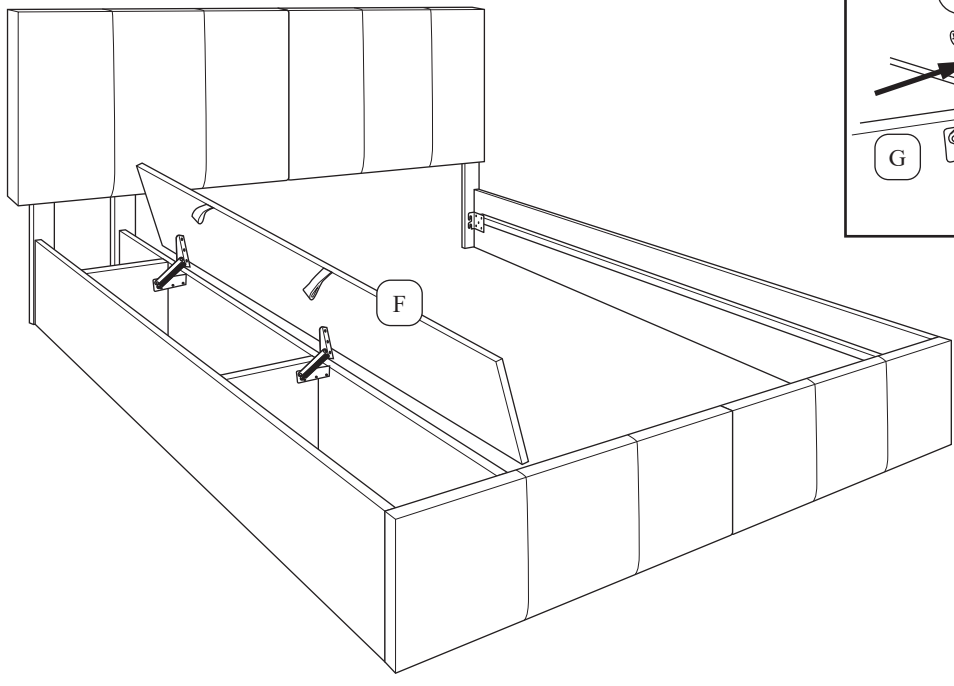

STEP 5

7	8	20
		
6 pcs	6 pcs	2 pcs



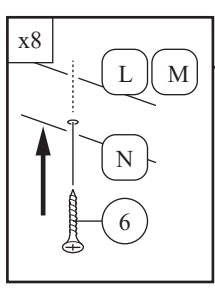
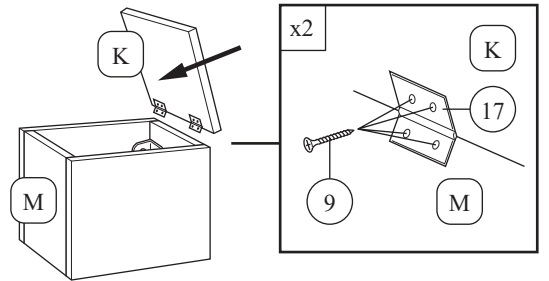
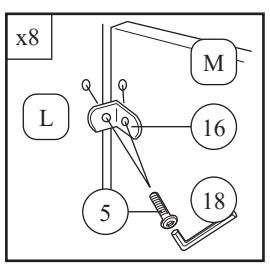
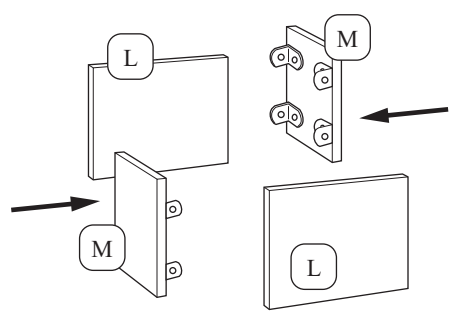

STEP 6

5	6	9	16	17	18
					
16 pcs	8 pcs	8 pcs	8 pcs	2 pcs	1 pc





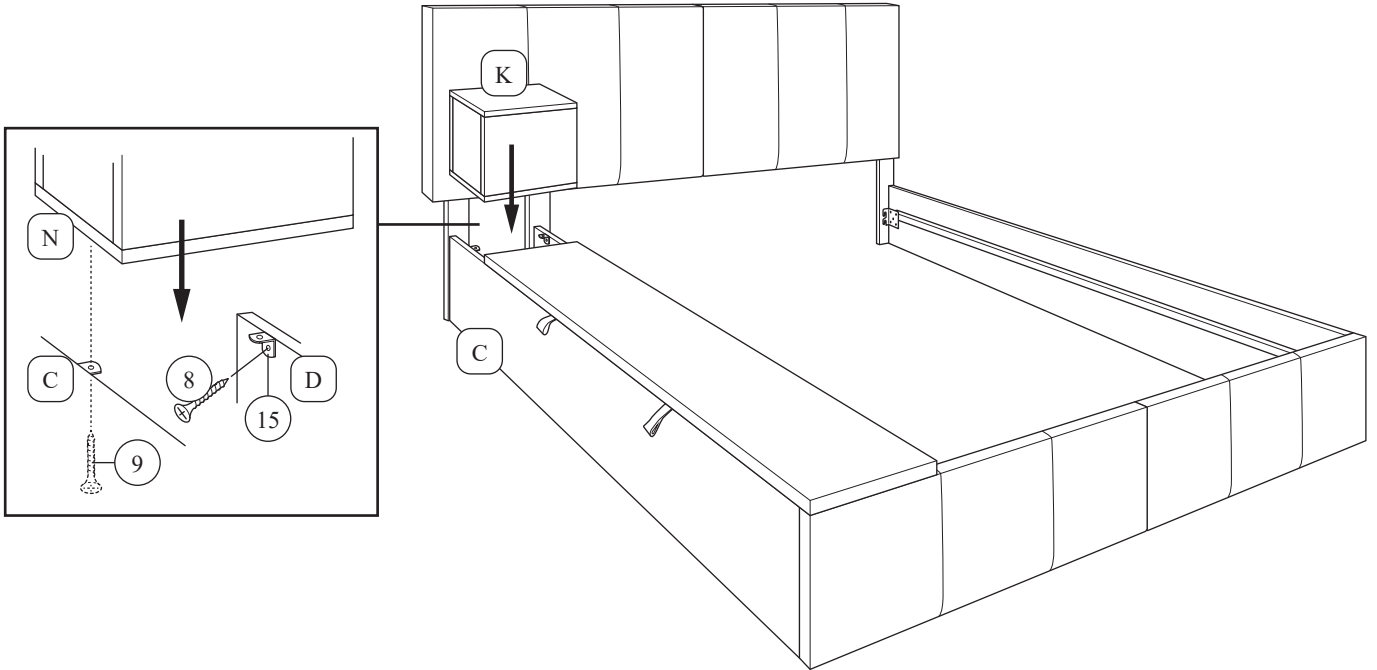

STEP 7

8	9	15
		
2 pcs	2 pcs	2 pcs



STEP 8

3	6	14	18
			
3 pcs	20 pcs	3 pcs	1 pc

