

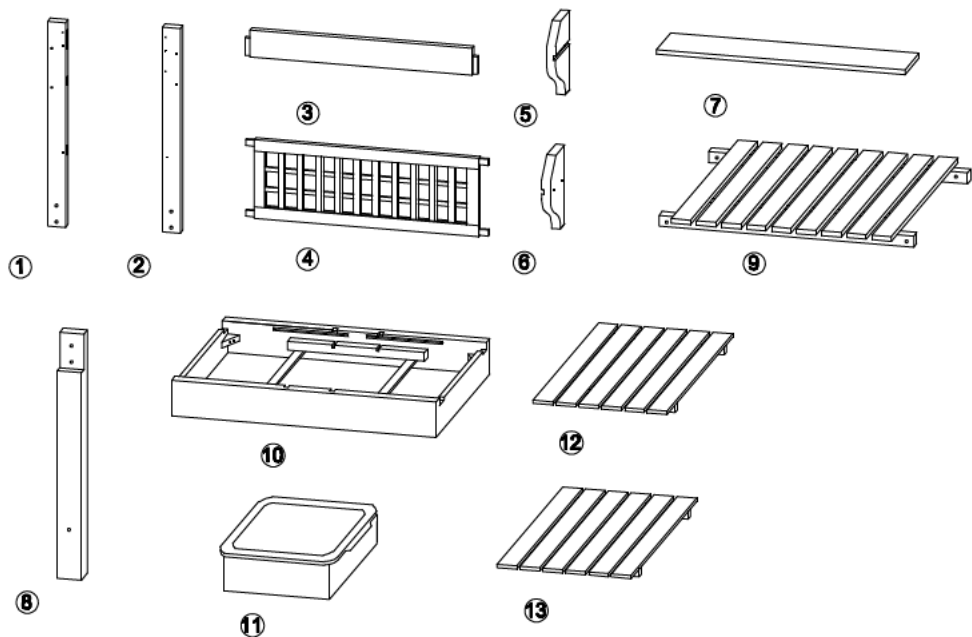









**USER'S MANUAL/HANDBUCH/MANUEL DE L'UTILISATEUR
/MANUAL DEL USUARIO/MANUALE UTENTE/INSTRUKCJA OBSŁUGI**

**Wooden Potting bench/Pflanztisch/Table de Jardinage/
Mesa de Plantación/Fioriera con Spalliera/Ławka doniczkowa**



- (A)**  **3x16mm**
(B)  **4.2x30mm**
(C)  **4.2x35mm**
(D)   **6x65mm**
(E)   **6x50mm**
(F)   **6x70mm**

