

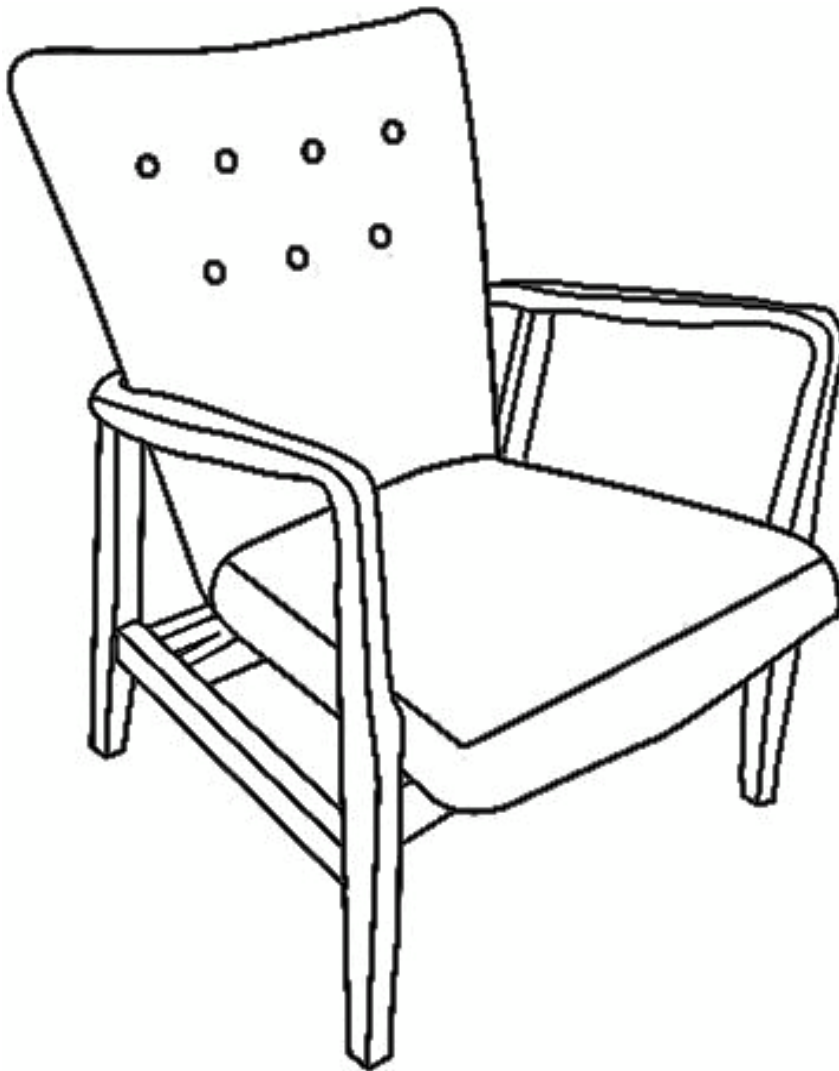

Assembly Instructions

Caution : You must read this before you proceed





Arm Chair

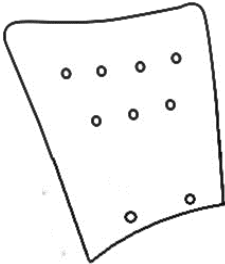
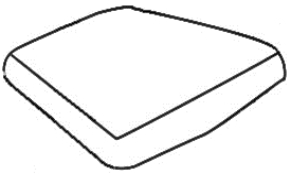

Parts List

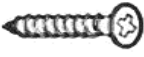
Label	Picture	Description	QTY
A		Frame	1
B		Back	1
C		Seat	1

Hardware

Label	Picture	Description	QTY
①		Bolt (M8*70MM)	3
②		Screw (M4*40mm)	7
③		Spring Washer	3
④		Washer	3
⑤		Allen Key	1
⑥		Screwdriver	1

Assembly Preparation

Before Beginning Assembly:

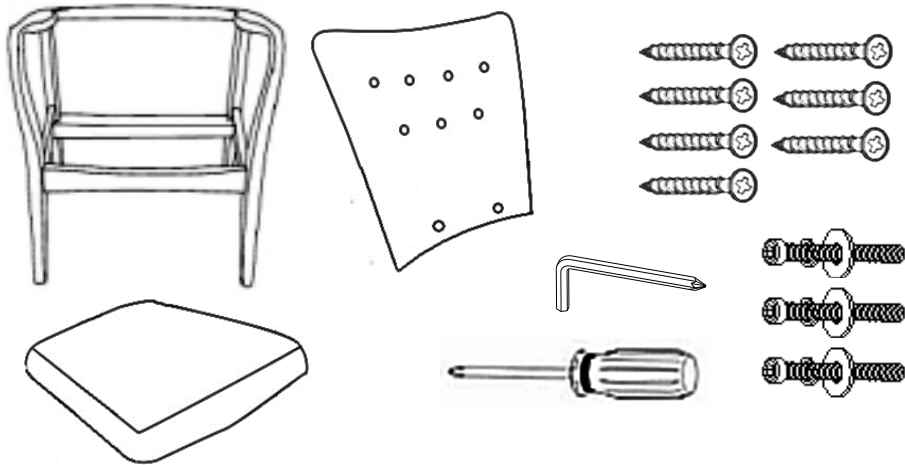

- Read instructions, cover to cover-



- Have 2 adults on hand for assembly-



- Do not assemble on flooring or carpet-



- Assemble on a clean non-marring surface (packing foam)-



- Save all packaging until finished-

Assembly Steps

Overview

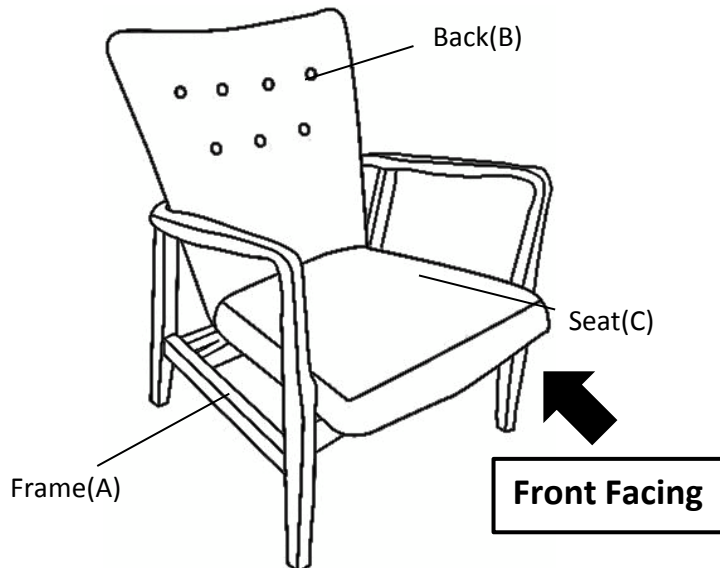

This Arm Chair has multiple parts and may require up to some 30 minutes to assemble. To give you an overview of the Arm Chair parts, the above picture is to help you put the various parts into perspective. Please read through the instructions below to familiarise yourself with the parts and steps before assembly.

Step 1

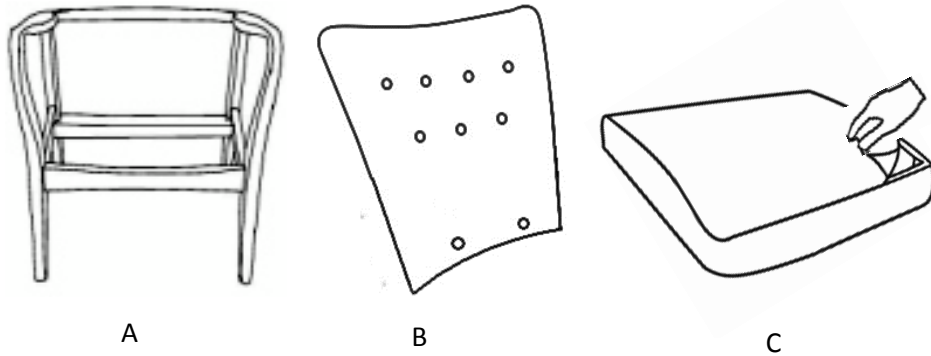

Place the Frame(A), Back(B) and Seat(C) on a clean, non-marring surface.
Carefully peel away the Dust Cover from the edge.

Step 2

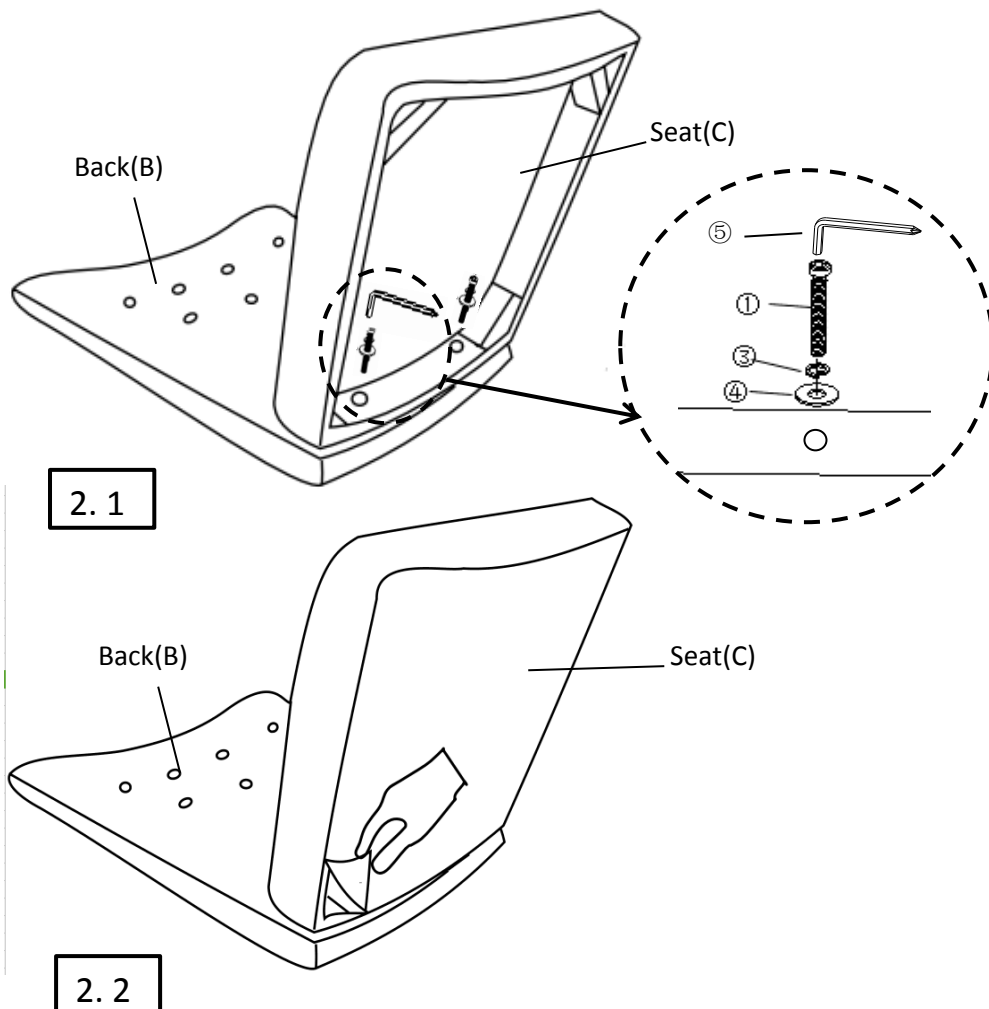

Put the Back(B) onto a clean, non-marring surface.

2.1) Align the mounting positions of the Back(B) with Seat(C) and attach them using Bolts(①), Spring Washers(③) and Washers(④) with Allen Key(⑤).

Friendly notice:

If the mounting positions cannot be aligned well and hinder the installation, then sway the Seat(C) lightly when locking the Bolts, this action could help prevent the Bolts from getting stuck and ensure smooth assembly.

2.2) Tighten the Bolts fully in a sequential manner; and then smooth down the Dust Cover with your hands on all four edges of the Seat bottom.

Step 3

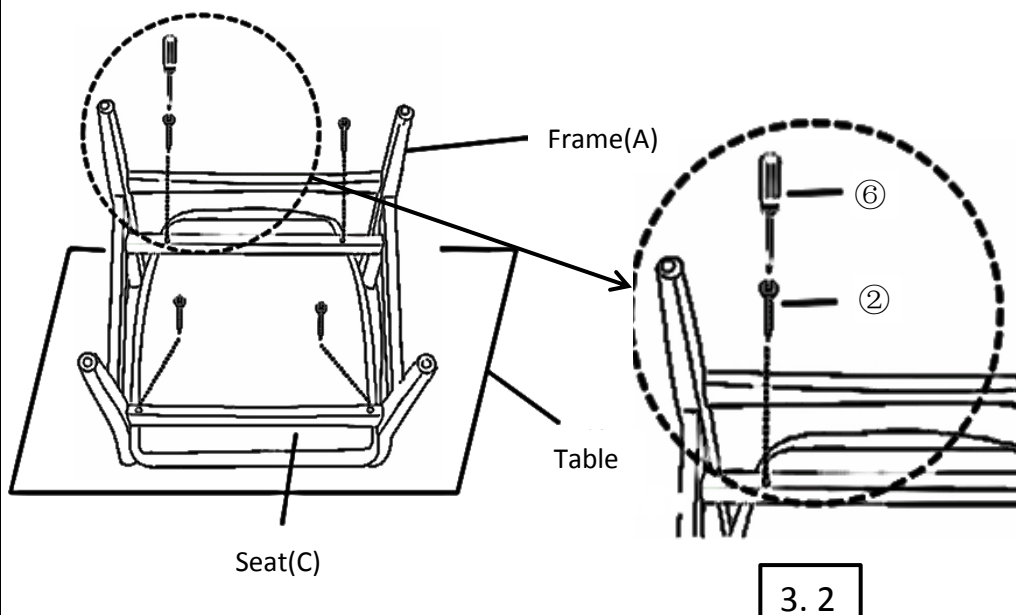
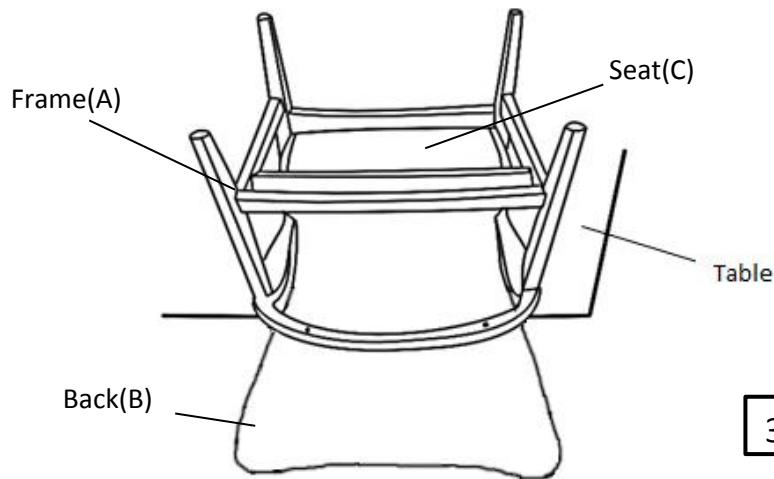

Place the assembled Seat(C) and Back(B) on the side of a table, with the Back(B) facing down.

3.1) Place the Frame(A) onto the assembled Seat(C) and Back(B) as shown in the picture.

3.2) Attach Frame(A) to Seat(C) using Screws(②) with Screwdriver(⑥).

Friendly notice:

If there are gaps between the Frame(A) and Seat(C) which hinders the Installation, then pull the Seat(C) upwards into the Frame(A), this action helps to ensure there are no gaps between them.

Do not fully tighten the Screws.

Step 4

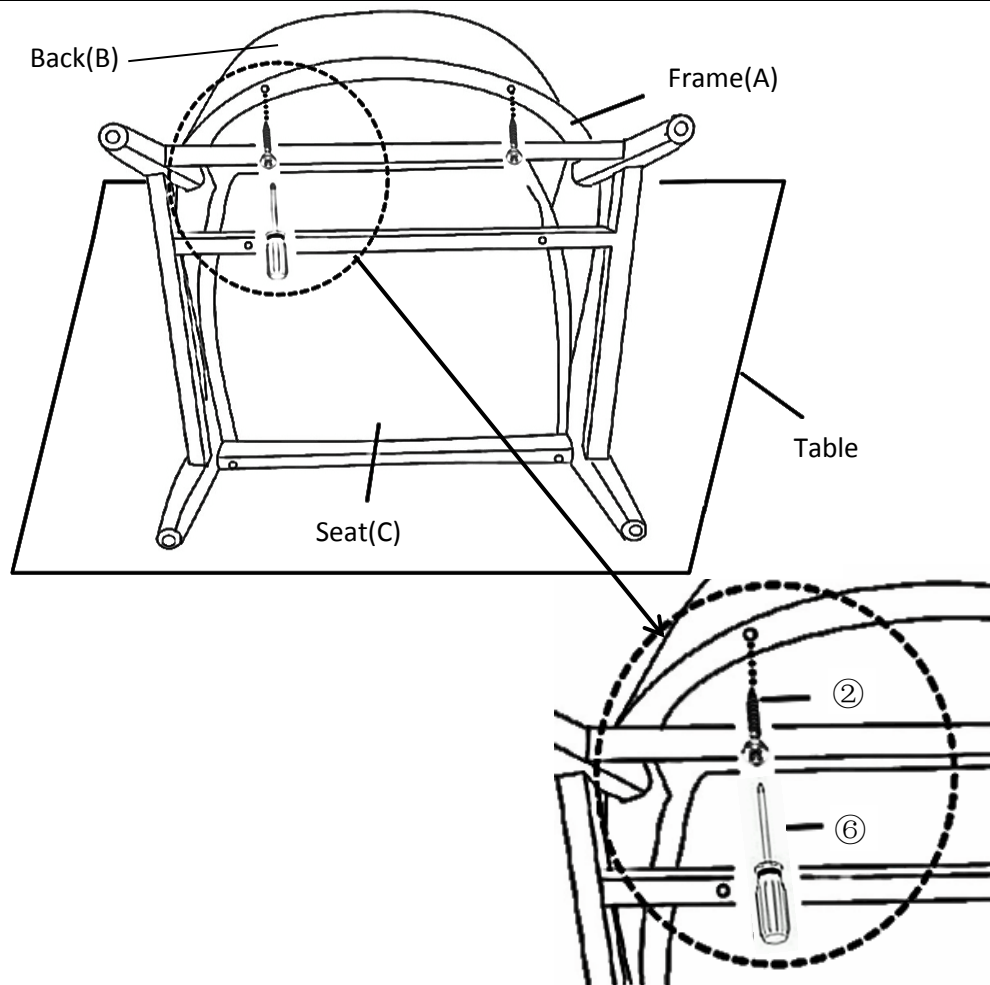

Attach Frame(A) to Back(B) using Screws(②) with Screwdriver(⑥). Pls press the Back(B) to Frame(A) hard before attaching

Do not fully tighten the Screws.

Step 5

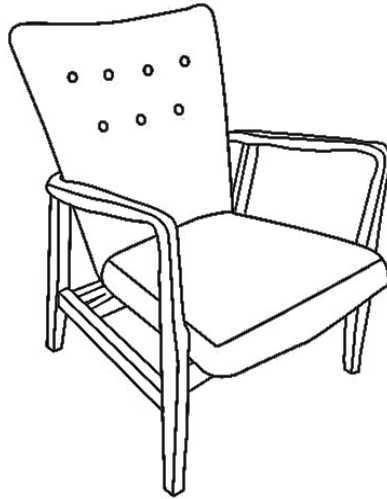

Finally, stand the Arm Chair right up, and place on a LEVEL SURFACE. Inspect it and make sure all parts are adequately connected.

Gently and gracefully, sit into the Arm Chair.

This would help to align all the parts at all the joint areas.

Then get off the Arm Chair, and place it facedown.

Tighten all Screws at all joints. Do not overtighten the Screws.

Overtightening could lead to damage to the product.

Tighten only until secure and stable.

If there is still wobbles, loosen the screws and execute this same process.



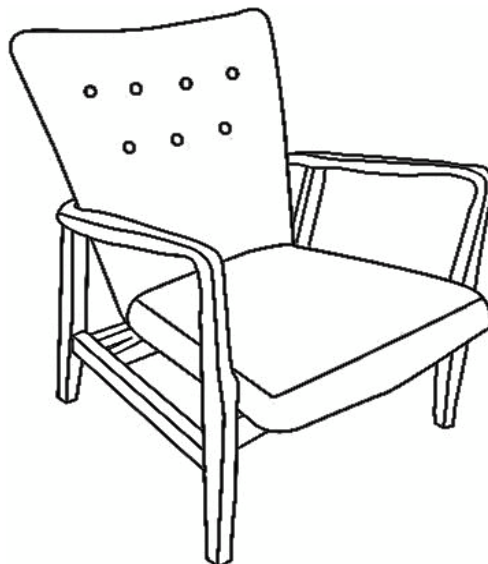

















Step 5



Your Arm Chair is ready for use.

This Arm Chair can only be used on a flat, level surface.

Care & Maintenance

-   ● Do not put hot items directly on furniture surface
 -   ● Do not clean furniture with harsh cleansers or polish.
 -   ● Do not place furniture under direct sunlight.
 -   ● Do not place furniture near heating or cooling vents.
 -   ● Do not write on furniture without a padded barrier to protect the surface.
 -   ● Do not place furniture outside . For indoor use only .
 -   ● Not for commercial use. For residential use only .
 -   ● Stains may be removed with mild soap solution and damp cloth.
 -   ● Children should not climb or jump on the furniture.
-
-   ● Dust and pick-up spills using a clean, non-colored, lint-free cloth .

Questions & Answers about Proposition 65

• What is Proposition 65?

Proposition 65 requires businesses to provide warnings to Californians about significant exposures to chemicals that cause cancer, birth defects or other reproductive harm. These chemicals can be in the products that Californians purchase, in their homes or workplaces, or that are released into the environment. By requiring that this information be provided, Proposition 65 enables Californians to make informed decisions about their exposures to these chemicals.

Proposition 65 also prohibits California businesses from knowingly discharging significant amounts of listed chemicals into sources of drinking water.

Proposition 65 requires California to publish a list of chemicals known to cause cancer, birth defects or other reproductive harm. This list, which must be updated at least once a year, has grown to include approximately 900 chemicals since it was first published in 1987.

• What types of chemicals are on the Proposition 65 list?

The list contains a wide range of naturally occurring and synthetic chemicals that include additives or ingredients in pesticides, common household products, food, drugs, dyes, or solvents. Listed chemicals may also be used in manufacturing and construction, or they may be byproducts of chemical processes, such as motor vehicle exhaust.

• What does a warning mean?

If a warning is placed on a product label or posted or distributed at a workplace, a business, or in rental housing, the business issuing the warning is aware or believes that it is exposing individuals to one or more listed chemicals.

By law, a warning must be given for listed chemicals unless the exposure is low enough to pose no significant risk of cancer or is significantly below levels observed to cause birth defects or other reproductive harm.

• Where can I get more information on Proposition 65?

If you have specific questions on the administration or implementation of Proposition 65, you can contact OEHHA's Proposition 65 program at P65.Questions@oehha.ca.gov, or by phone at (916) 445-6900.