

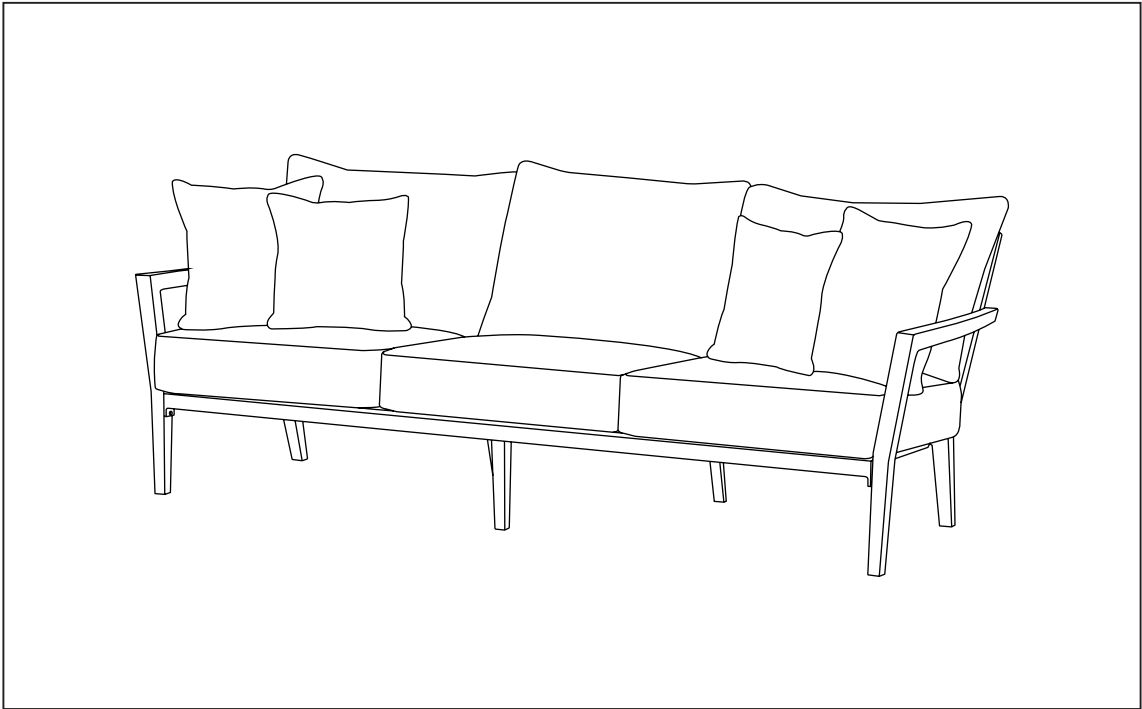

# 88" Sofa



## ASSEMBLY INSTRUCTIONS

**IMPORTANT, RETAIN FOR FUTURE REFERENCE.  
READ CAREFULLY.**

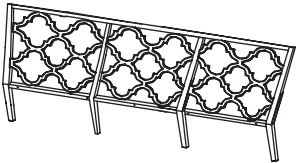
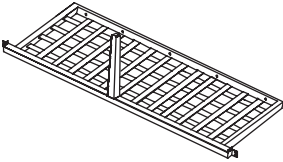
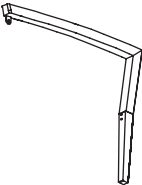
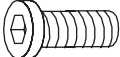
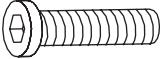
# PARTS LIST

NO	PICTURE	PART DESCRIPTION	QTY.
A		Sofa back	1
B		Sofa seat	1
C		Sofa arms	2
D		Bolt (M6 x 20)	8
E		Bolt (M6 x 35)	5
F		Washer (15*8.5*1.0)	13
G		Allen wrench	1

# Step 1.

**ATTACH SOFA SEAT TO SOFA BACK** - Attach the sofa seat (B) to the sofa back (A) using bolts (E), washers (F), and allen wrench (G).

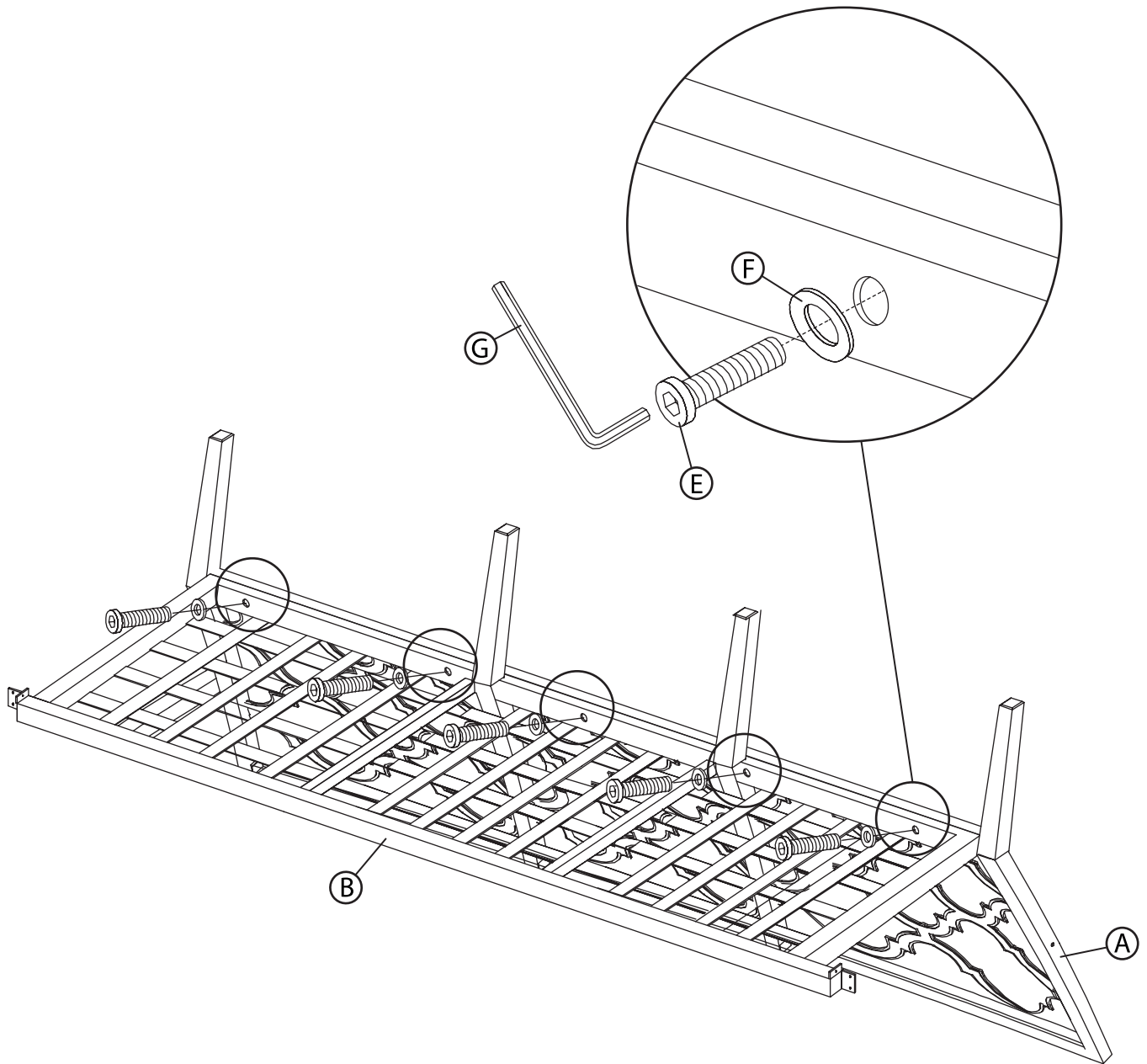

## Step 2.

**ATTACH SOFA ARMS** - Attach the sofa arms to the sofa seat (B) and the sofa back (A) using bolts (D), washers (F), and allen wrench (G).

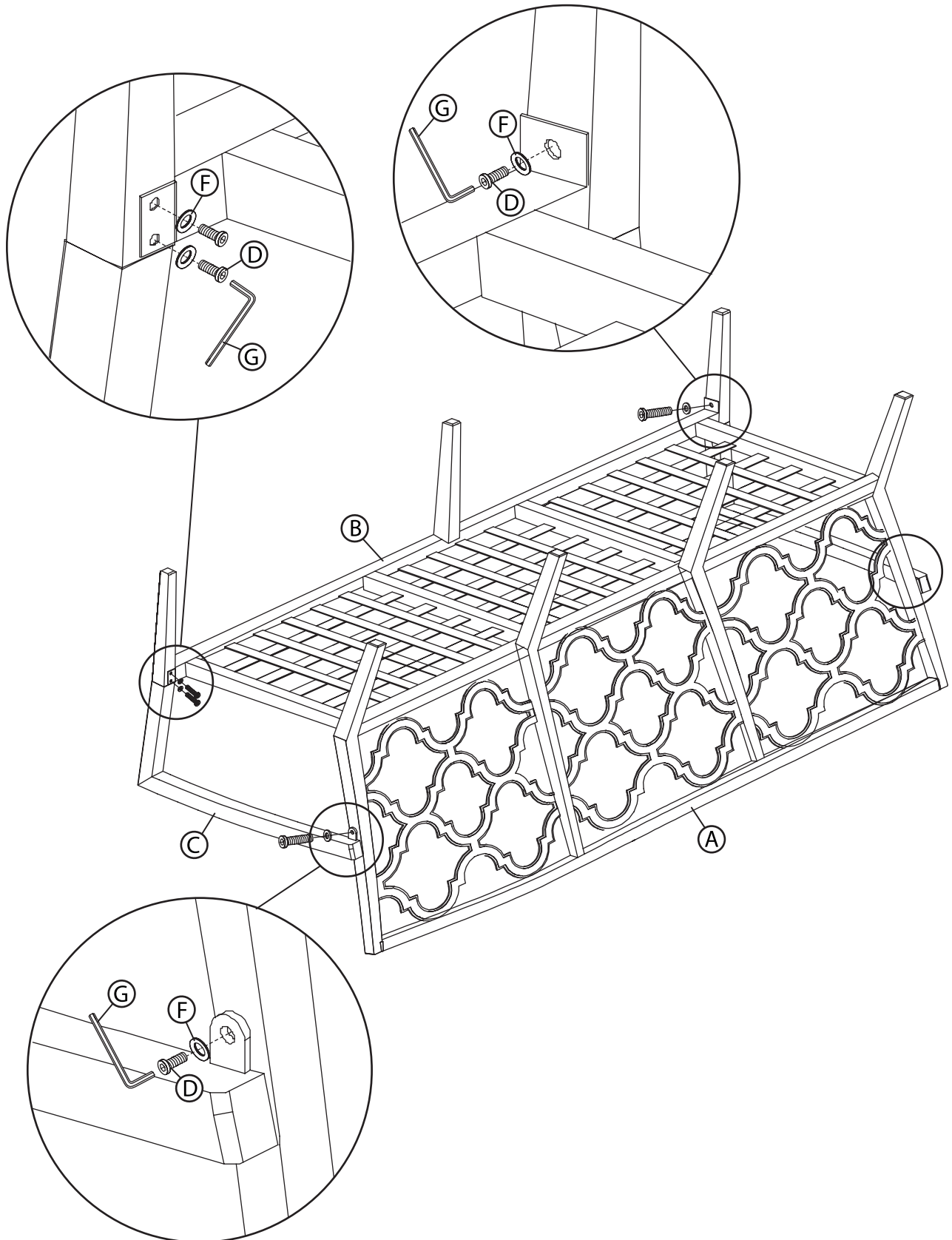

## Care and Maintenance

All outdoor furniture is subject to UV rays and weather elements. In order to keep your furniture as long lasting and vibrant as possible, we advise using furniture covers or storing the furniture when not in use.

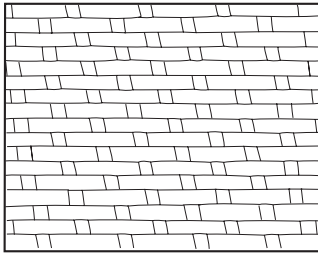

### WICKER

Simply washing your wicker with a mild detergent and protecting it as much as possible by covering and or storing it when not in use for long periods of time is sufficient.

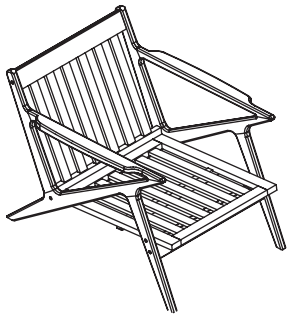

### WOOD FRAMES

Make sure all surfaces are protected from heat and liquids. Wipe up spills immediately and do not place furniture next to a heat source such as radiators or fires. All timber surfaces may change color. Spray polishes are best to avoid as they contain silicones which may spoil the surface by building up overtime. Check bolts and screws regularly and tighten when necessary.

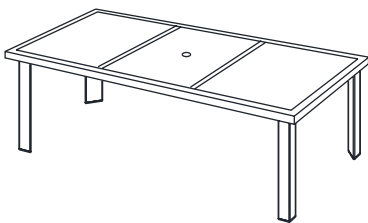

### STONE TOPS/ TABLE TOPS

Spills should be wiped up quickly to avoid any staining on the surface. Regular cleaning with mild soap and water with a sponge or soft scrub brush is all that is required. Storing or covering your natural stone top when not in use for extended periods of time is recommended.

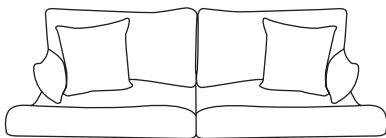

### FABRICS

Wipe off spills with a cloth and water. We uses Sunbrella® fabrics designed to protect and last for several years. Sunbrella fabrics are treated with a proprietary water and stain repellent. If needed to revive fabrics Glen Raven® recommends 303® Fabric Guard™.

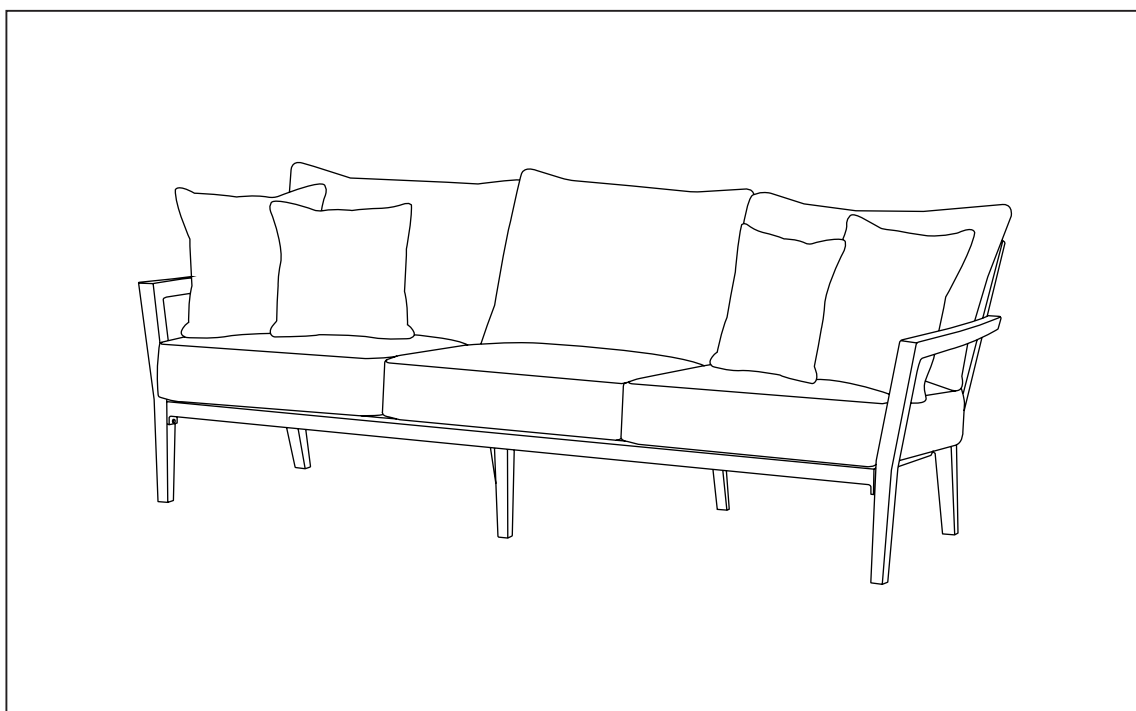

# Canapé 244 cm



## INSTRUCTION D'ASSEMBLAGE

**IMPORTANT, À CONSERVER À TITRE DE RÉFÉRENCE. À LIRE ATTENTIVEMENT.**

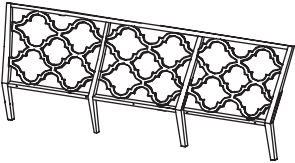
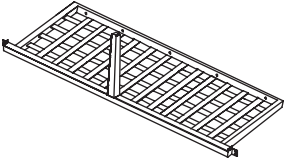
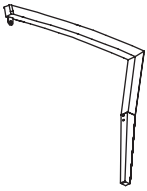
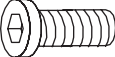
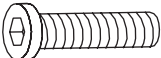
# LISTE DES PIÈCES

NO	IMAGE	RÉFÉRENCE DESCRIPTION	QTÉ
A		Dossier du canapé	1
B		Siège de canapé	1
C		Bras de canapé	2
D		Boulon (M6 x 20)	8
E		Boulon (M6 x 35)	5
F		Rondelle (15*8.5*1.0)	13
G		Clé Allen	1

## Étape 1.

**FIXEZ LE SIÈGE DU CANAPÉ AU DOSSIER DU CANAPÉ** - Fixez le siège du canapé (B) au dossier du canapé (A) à l'aide de boulons (E), de rondelles (F) et d'une clé Allen (G).

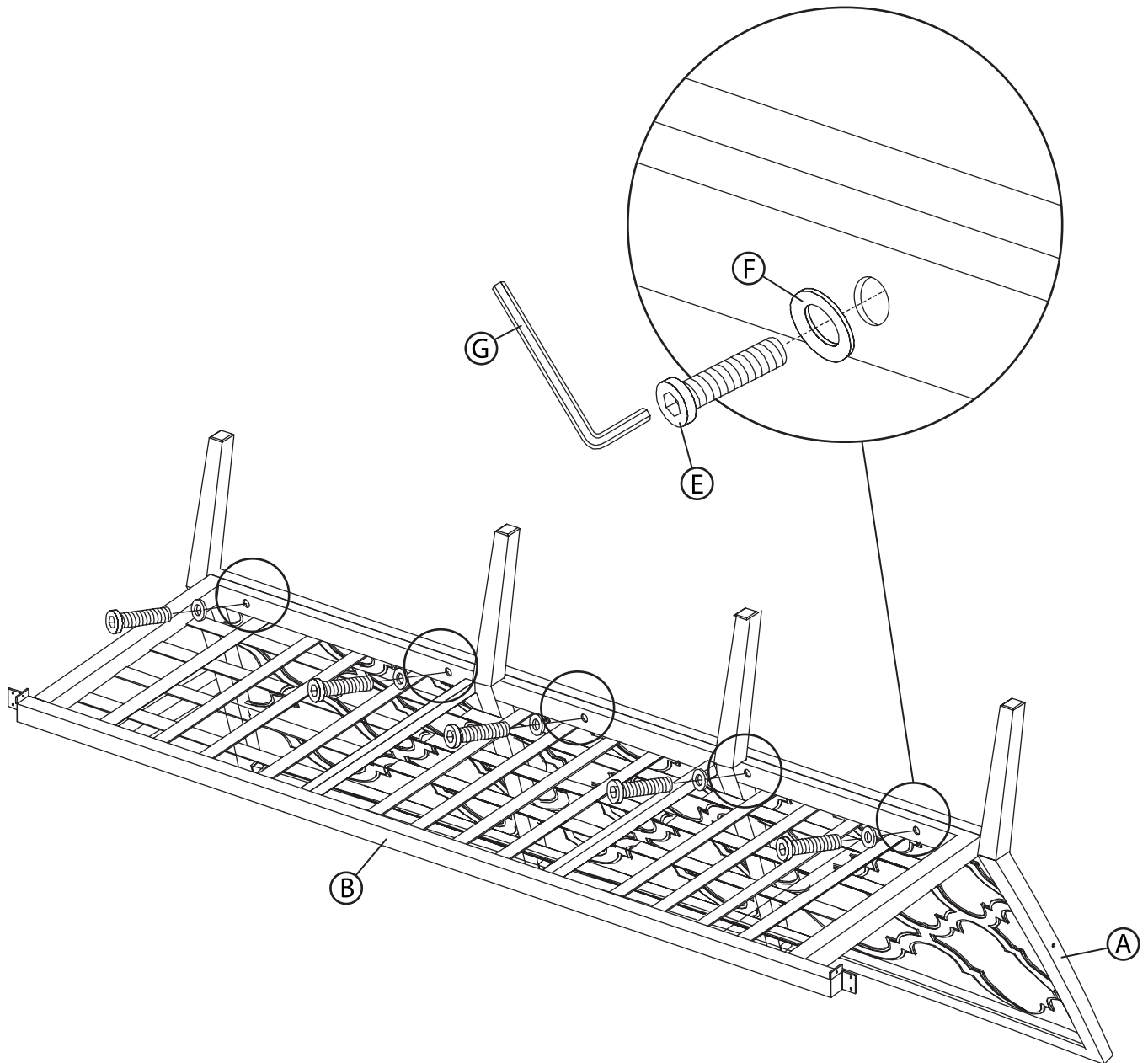

## Étape 2.

**FIXEZ LES BRAS DU CANAPÉ** - Fixez les bras du canapé au siège du canapé (B) et au dossier du canapé (A) à l'aide de boulons (D), de rondelles (F) et d'une clé Allen (G).

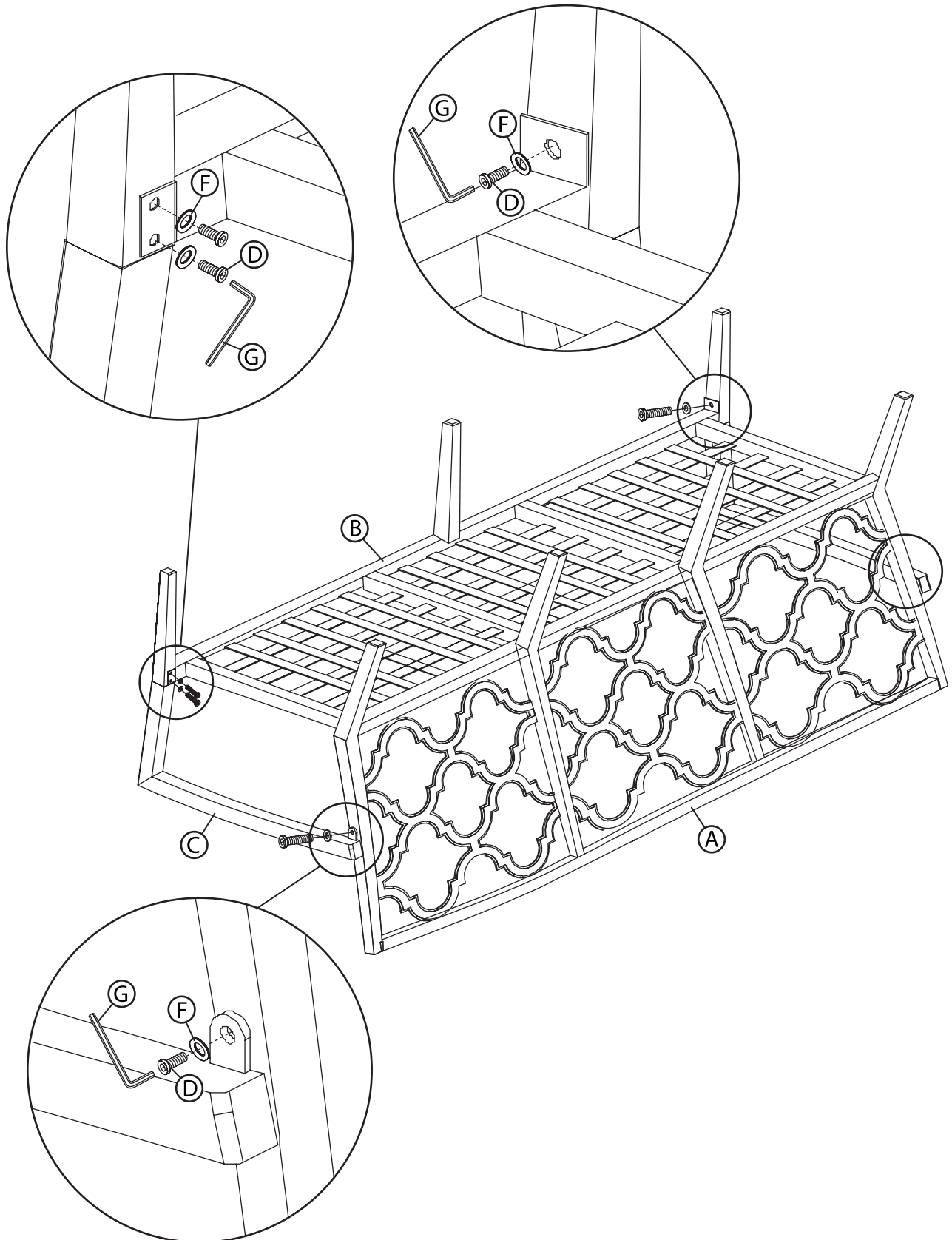

## Soins et Entretien

Tout meuble à l'extérieur est soumis aux rayons UV ainsi qu'aux éléments météorologiques. Afin de préserver vos meubles aussi longtemps et aussi vibrants que possible, nous vous conseillons de les couvrir ou de les garder à l'intérieur lorsqu'ils ne sont pas utilisés.

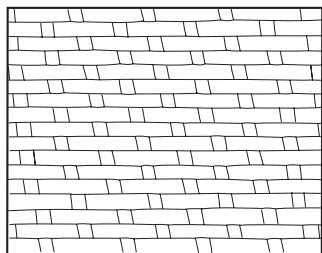

### OSIER

Laver simplement vos meubles en osier avec un détergent léger, en les protégeant autant que possible en les couvrant ou en les gardant à l'intérieur lorsqu'ils ne sont pas utilisés, est suffisant.

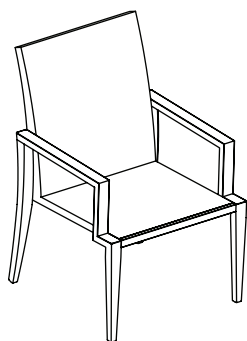

### CADRES EN ALUMINIUM

Les meubles incorporent des cadres recouverts en aluminium qui sont conçus pour nécessiter un entretien mini-mum. Évitez de laisser trop de poussière s'empiler en les lavant avec du savon doux et de l'eau. Ne laissez jamais de meuble sous l'eau.

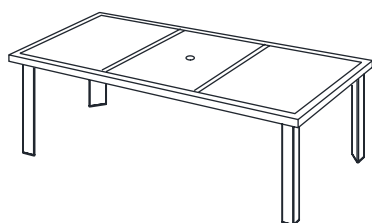

### SURFACES EN PIERRE / DESSUS DE TABLE

Les liquides renversés doivent être nettoyés rapidement pour éviter toute tache sur la surface. Un lavage régulier avec un savon doux et de l'eau en utilisant une éponge ou une brosse souple est l'unique chose requise. Ranger ou couvrir votre surface en pierres naturelles lorsqu'elle n'est pas utilisée pendant une durée étendue est recommandé.

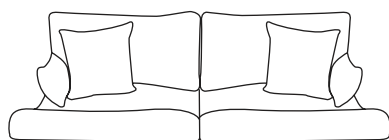

### TISSUS

Nettoyez les liquides renversés avec un tissu et de l'eau. Utilisez Sunbrella®, conçu pour protéger et durer pendant plusieurs années. Les tissus Sunbrella sont traités avec de l'eau et du produit anti-taches. Si nécessaire pour faire revivre les tissus, Glen Raven® recommande 303® Fabric Guard™. Pour plus d'informations,

p

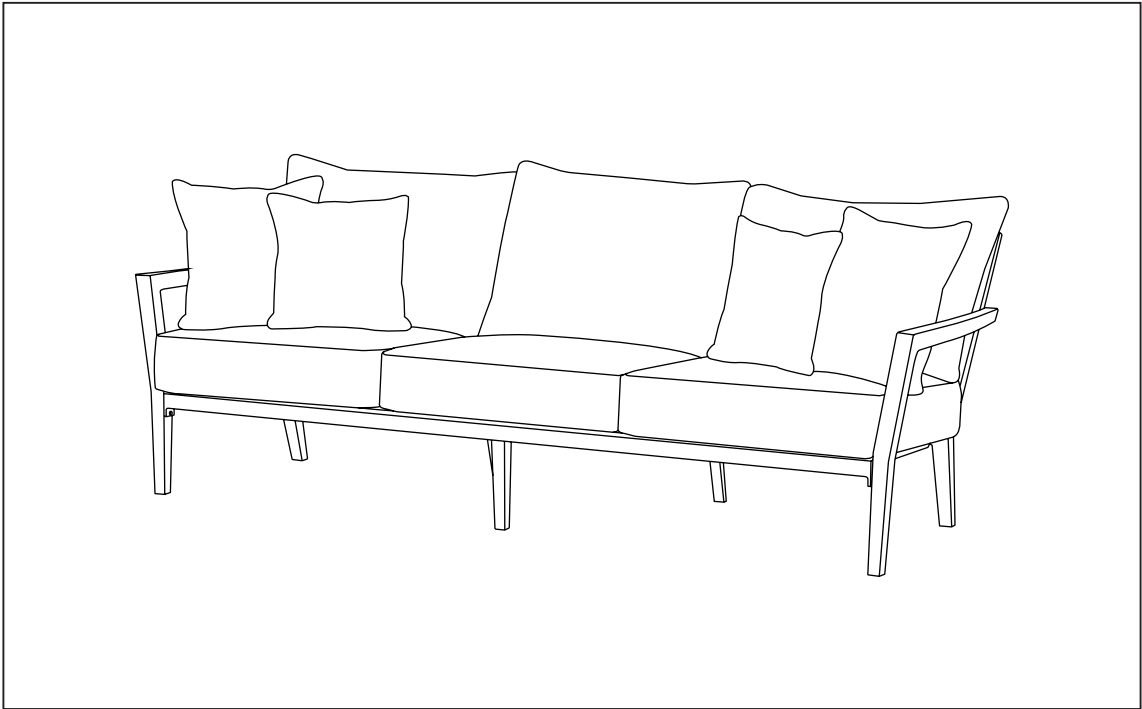

# Sofá de 224 cm



**MANUAL DE INSTRUCCIONES Y ENSAMBLE**

**IMPORTANTE, RETENER PARA FUTURAS CONSULTAS.  
LEA CUIDADOSAMENTE.**

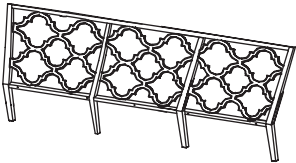
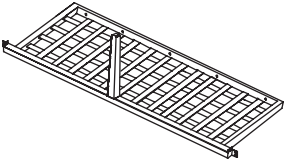
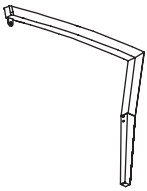
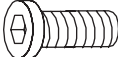
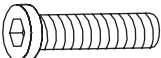
# LISTA DE PARTES

NO	IMAGEN	DESCRIPCIÓN (PARTE)	CANT.
A		Respaldo	1
B		Asiento	1
C		Brazo	2
D		Perno (M6 x 20)	8
E		Perno (M6 x 35)	5
F		Arandela (15*8.5*1.0)	13
G		Llave allen	1

# Paso 1.

**FIJE EL ASIENTO DEL SOFÁ AL RESPALDO DEL SOFÁ** - Fije el asiento del sofá (B) al respaldo del sofá (A) con los pernos (E), las arandelas (F) y la llave Allen (G).

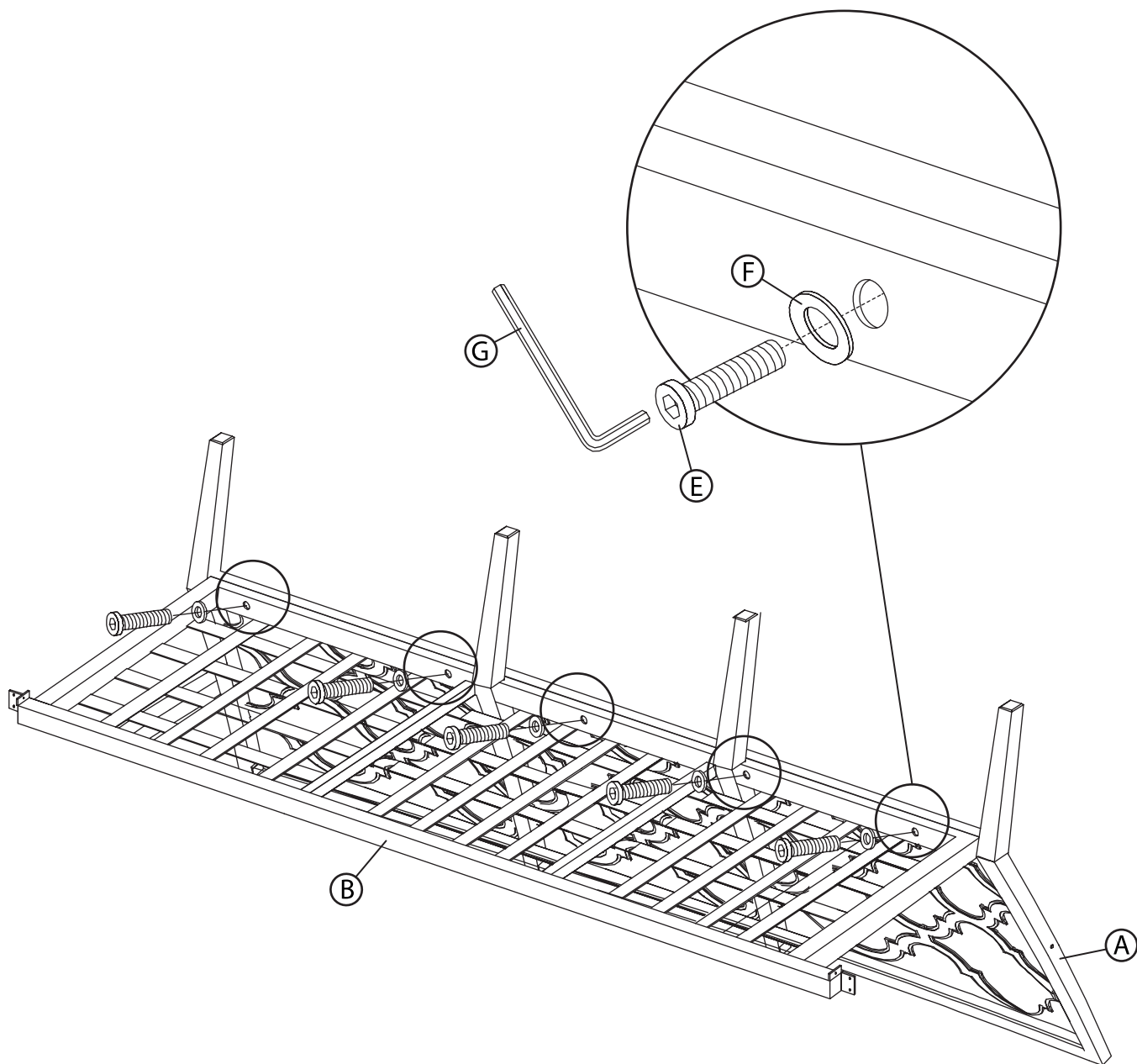

## Paso 2.

**FIJE LOS BRAZOS DEL SOFÁ** - Fije los brazos del sofá al asiento del sofá (B) y al respaldo del sofá (A) con los pernos (D), las arandelas (F) y la llave Allen (G).

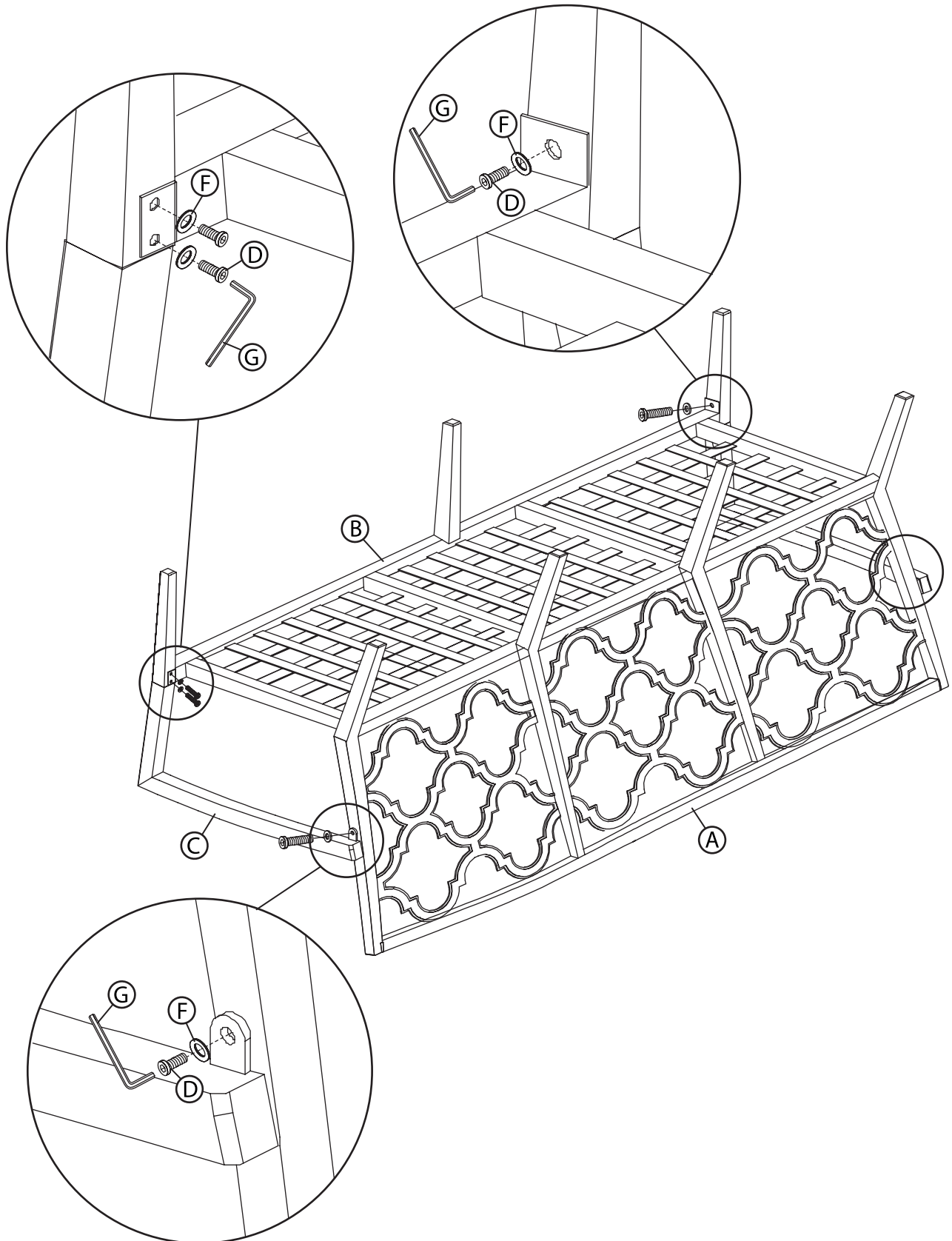

## Cuidados y Mantenimiento

Todo mobiliario al aire libre está sujeto a los rayos ultravioleta y las inclemencias meteorológicas. Para que sus muebles duren y los colores se mantengan tan vibrantes como sea posible, aconsejamos cubrirlos o guardarlos cuando no estén en uso.

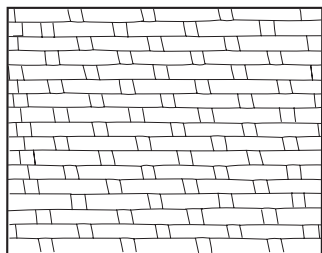

### MIMBRE

Simplemente lave sus muebles de mimbre con un detergente suave y protéjalos cubriéndolos o guardándolos cuando no los use durante largos períodos de tiempo.

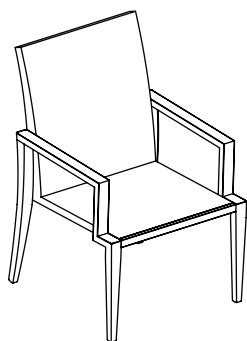

### ESTRUCTURAS DE ALUMINIO

Los muebles de están construidos con estructuras recubiertas con polvo de aluminio diseñados para necesitar mantenimiento mínimo. Evite que se acumule demasiada suciedad limpiando con agua y jabón suave. Nunca deje muebles sobre el agua.

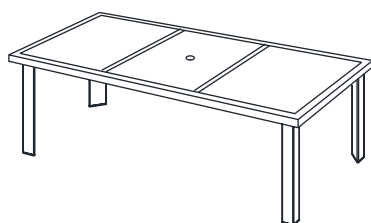

### SUPERFICIES DE PIEDRA / MESA

Limpie los derrames rápidamente para evitar manchas en la superficie. La limpieza regular con agua y jabón suave con una esponja o cepillo es todo lo que se necesita. Se recomienda almacenar o cubrir la superficie de piedra natural cuando no está en uso durante períodos prolongados de tiempo.

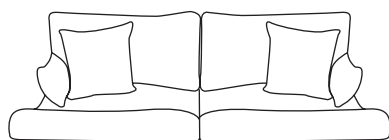

### TEJIDOS

Limpie los derrames con un paño y agua. utiliza tejidos Sunbrella® que están diseñados para proteger y durar varios años. Los tejidos Sunbrella se tratan con un repelente de agua y manchas de fórmula patentada. Si es necesario para reavivar los tejidos Glen Raven® se recomienda usar 303© Fabric Guard™.