

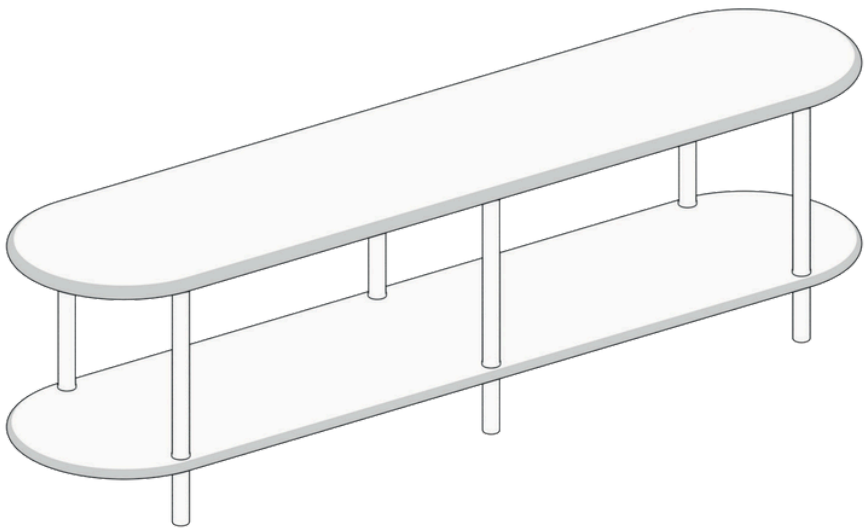

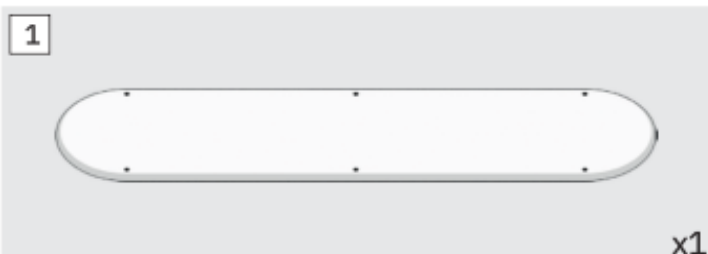



Installation & Assembly

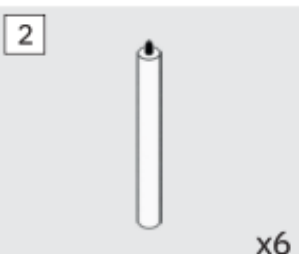

In order for warranty conditions to be valid, please follow the instructions on the manual. Please place all the parts on a flat surface and read the manual carefully for easy and exact assembly. Please match all the parts with instruction manual. You can contact us through for all your questions.

Parça Listesi	Part List	Parça No/Part No	Adet/Piece
		1	x1
		2	x6
		4	x6

1. Adım



Montaja başlamadan önce vida başlıklarını çıkartınız.

Step 1



Remove the protective caps before assembly.



2. Adım



Step 2

