



General Manual for 17" Tall Modular Metal Raised Garden Bed

Gardening Made Easier. Anytime, Anywhere.

Copyright © 2025 Vego



**Gardening
Made Easier.
Anytime,
Anywhere.**



Contact Us



+1 (866) 597-1888



Vego Garden Academy



hello@vegogarden.com



vegogarden.com



vego_garden









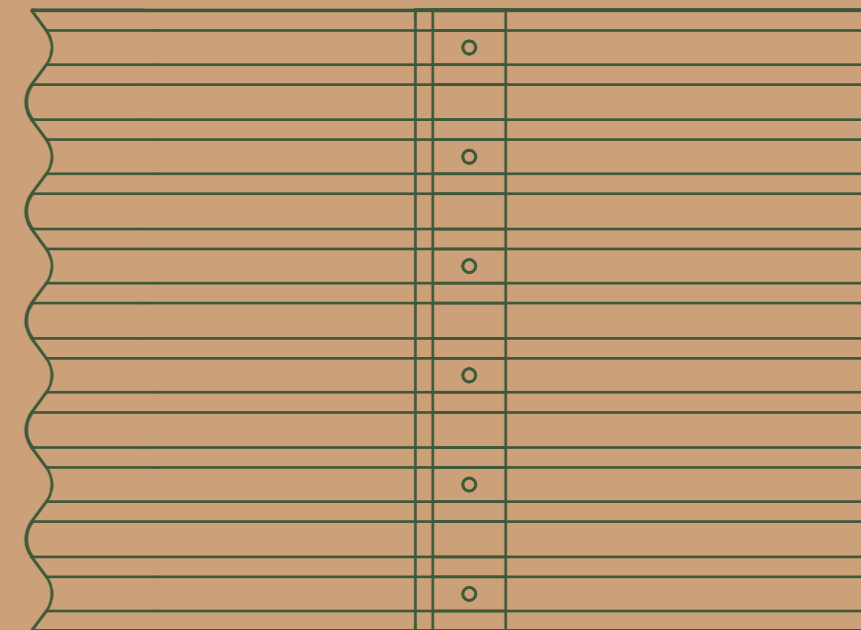



Houston, TX

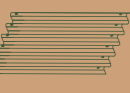

Assembly Videos



Parts List

Configuration	4 In 1 Kit	6 In 1 Kit	9 In 1 Kit	10 In 1 Kit
Parts				
 C10 Corner Panel	4	4	4	
 C12 Corner Panel				4
 S15 Side Panel	4	6	8	4
 S20 Side Panel				4
 B1 Bolt M6X10	48	60	72	72
 FCN Flange Cap Nut	16	20	24	24
 FSN Flange Standard Nut	32	40	48	48
 2ft Bracing Rod			1	
 Bracing Rods (Rod A + Rod B)				2
 SE Safety Edging	1	1	1	1
 LW L Wrench	1	1	1	1

Visit vegogarden.com for more info.

Configurations

Designed to be modular, Vego Garden Raised Beds can be assembled into one of many configurations to best fit your garden space. Find your kit, and choose a configuration below.

Note: Due to the manufacturing process, dimensions may vary by ± 2 inches.

● 4 In 1 Kit

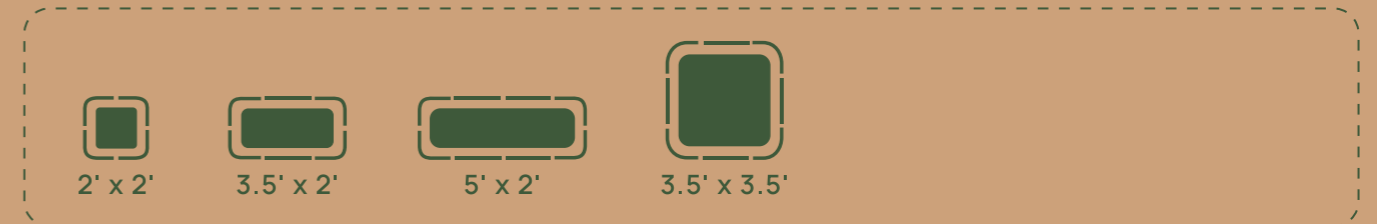

● 6 In 1 Kit

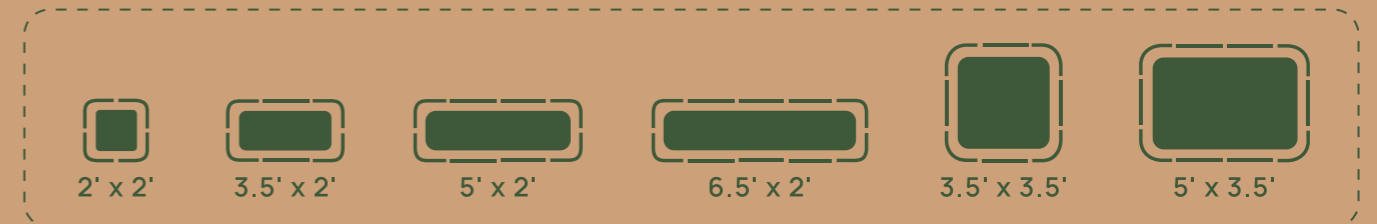

● 9 In 1 Kit

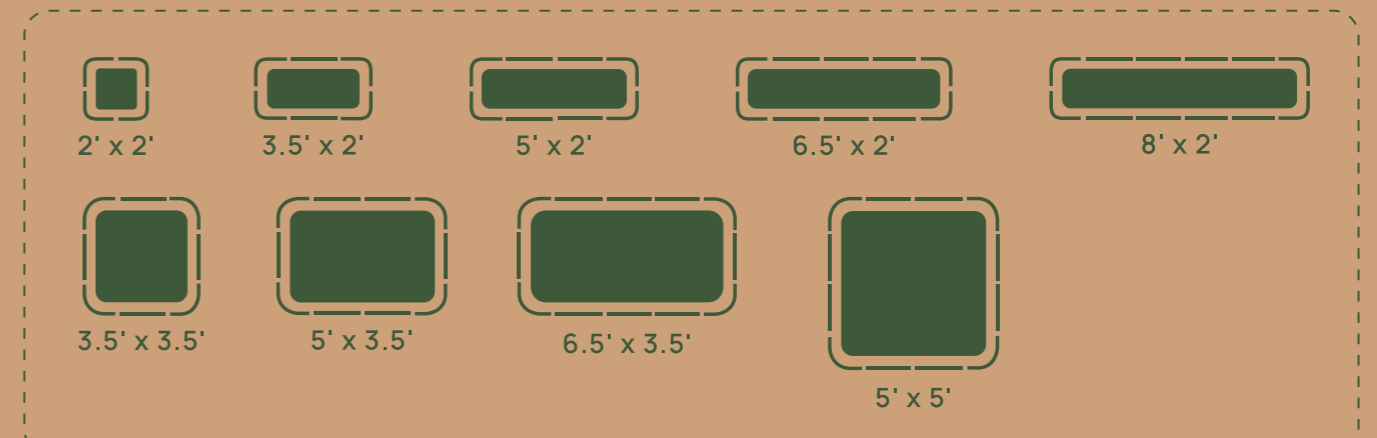

● 10 In 1 Kit

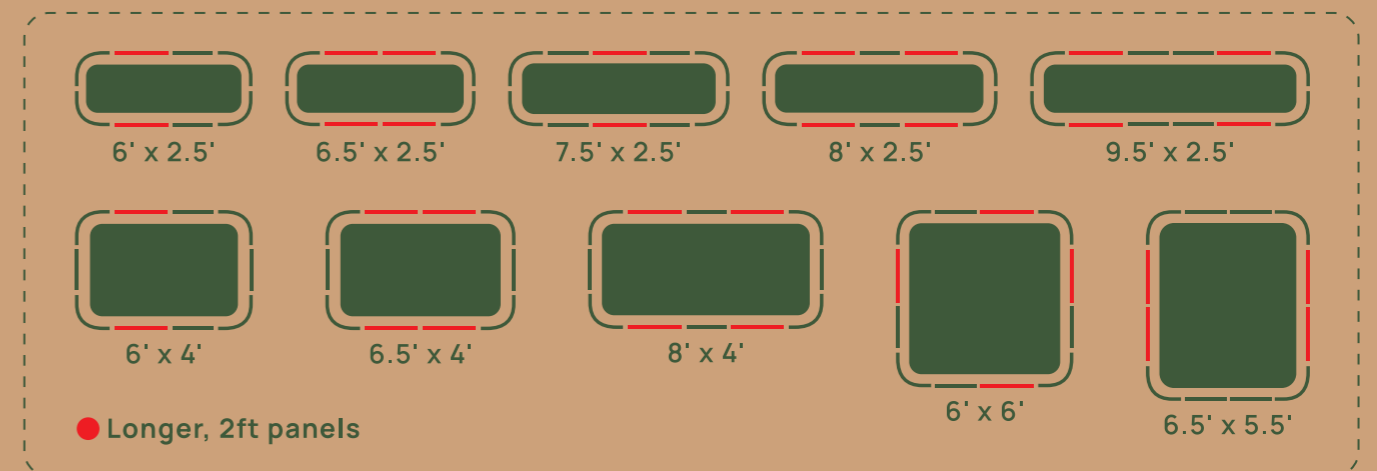

Visit vegogarden.com for more info.

Safety Precautions

This product may contain sharp metal corners and edges. To prevent injury:

- Handle with care at all times
- Wear gloves, closed-toe shoes & long pants when handling
- Work on a stable, clean surface away from children and pets
- Follow all instructions carefully and use tools only as directed

If you are unsure about any step, pause and seek assistance.



Assembly Guide

www.vegogarden.com/assembly

- 1** Remove protective film from both sides of all panels. Find a flat working surface, and lay the panels out according to the configuration you chose (pg. 2).

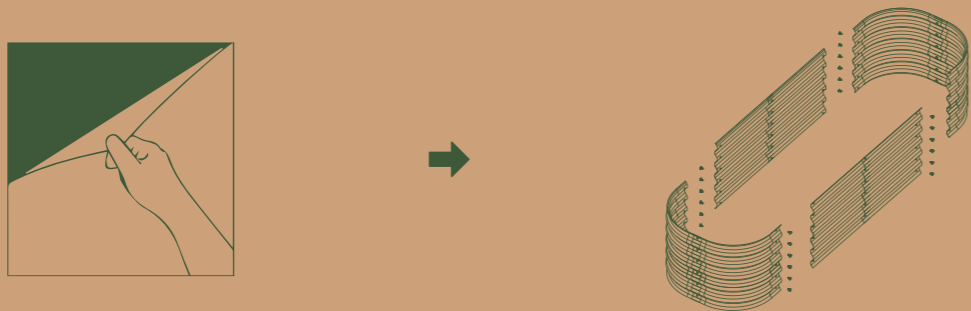

- 2** Loosely assemble all straight panel sections, using cap nuts on the top two rows, and standard nuts on the bolts below.

Note: For 10 in 1 kits refer to the diagram on page 2 to ensure the straight panel lengths are assembled in the appropriate order.

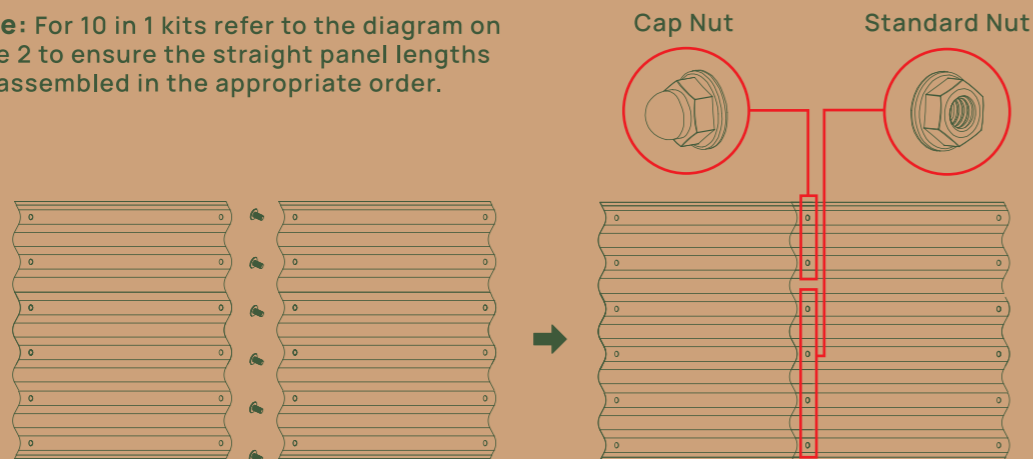

- 3** Once all straight panel sections are loosely connected, tighten all nuts.

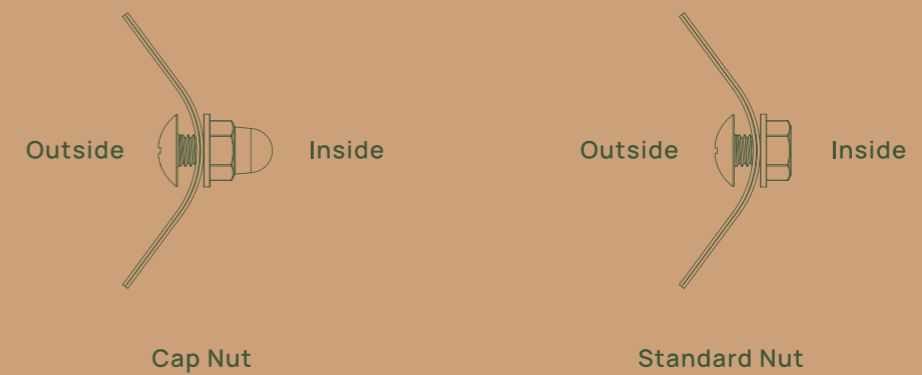

- 4** Assemble corner panel sections using the same method. Then attach corner sections to straight sections, ensuring corners are attached on the outside of straight panels.

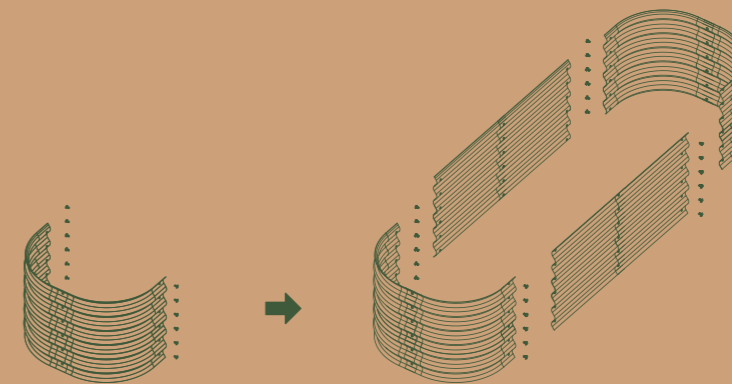

- 5** Push and guide the safety edging along the top rolled steel edge, and trim away any extra length.

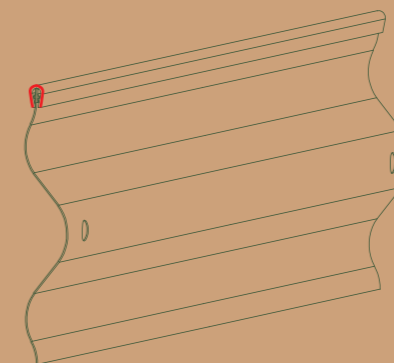

- 6 For 9 in 1 Kits, 2ft x 8ft beds:**
Install the 2ft bed bracing rod between two opposite bolt holes in the center of the bed. Attach the bolt, panel, & rod loosely in the **4th hole** from the top of the bed, then tighten to reinforce.

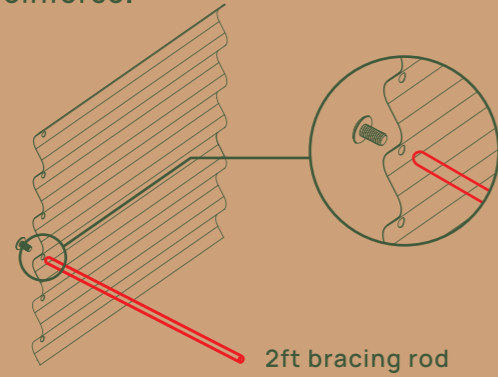

- 7 For 10 in 1 Kids, 2.5ft wide:**
All 2.5ft wide configurations require bracing rods. For these configurations use rod A's on either side of the center seam. Attach the bolt, panel, & rod loosely in the **4th hole** from the top of the bed, then tighten to reinforce.

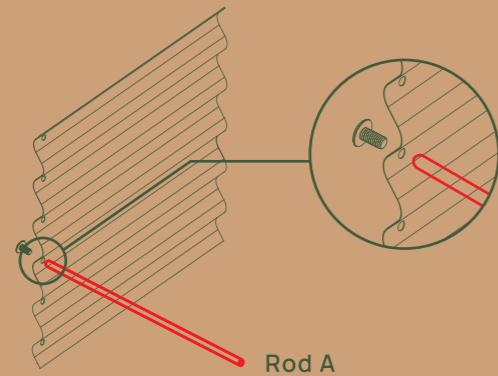

- 8 For 10 in 1 Kits, 4ft wide:**
All 4 ft wide configurations require bracing rods. Connect rod A to rod B using the threaded pins, then install in the two center-most seams. Attach the bolts, panels, & rods loosely in the **4th holes** from the top of the bed, and tighten to reinforce.

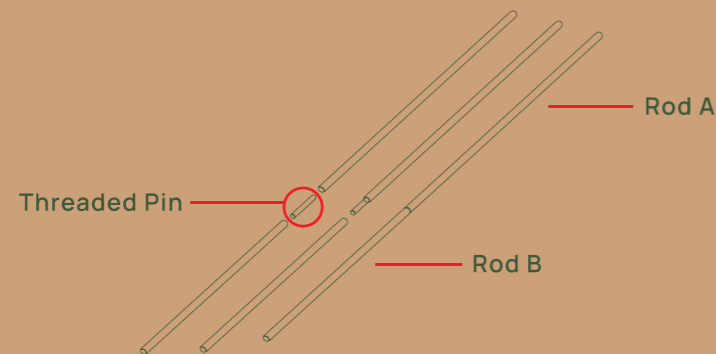

9 Bracing Rod Diagrams

