

## CARE AND MAINTENANCE











Unplug lamps before using any cleaning solutions. Dust shades with a feather duster or with an appropriate vacuum-brush attachment. Wipe with a soft, dry cloth and clean lamp bases with the methods appropriate to the material. Avoid the use of chemicals and household cleaners as they may damage the finish.

## NOTICE & IMPORTANT SAFETY INSTRUCTIONS

- \* Please make sure that you have all parts indicated before you begin assembly of this item
- \* This item should be assembled on a soft surface to prevent scratching the finish during assembly
- \* To reduce the risk of fire, electrical shock or injury to persons or property, please follow the guideline below for safe use and installation
- \*The external flexible cable or cord of this luminaire cannot be replaced;  
If the cord is damaged, the luminaire shall be destroyed

\*\*This portable lamp has a polarized plug (one blade is wider than the other) as a safety feature to reduce the risk of electric shock. this plug will fit in a polarized outlet only one way. if the plug does not fit fully in the outlet, reverse the plug, if it still does not fit, contact a qualified electrician. never use with an extension cord unless the plug can be fully inserted. do not attempt to defeat this safety feature.

### Part List and Hardware List

| PIECE | DESCRIPTION  | PICTURE   | QUANTITY | PIECE | DESCRIPTION      | PICTURE   | QUANTITY |
|-------|--------------|---|----------|-------|------------------|---|----------|
| A     | Lamp base    |    | 1X       | G     | Rotary connector |    | 1X       |
| B     | Lamp Body    |   | 1X       | H     | Steel Tube 3     |   | 1X       |
| C     | Steel Tube 1 |  | 1X       | I     | Steel shade      |  | 1X       |
| D     | Socket       |  | 1X       | J     | Out ring         |  | 1X       |
| E     | Tube Cup     |  | 1X       | K     | Bulb             |  | 1X       |
| F     | Steel Tube 2 |  | 1X       |       |                  |   |          |

Product Dimensions: 23.5X9.625X62"H

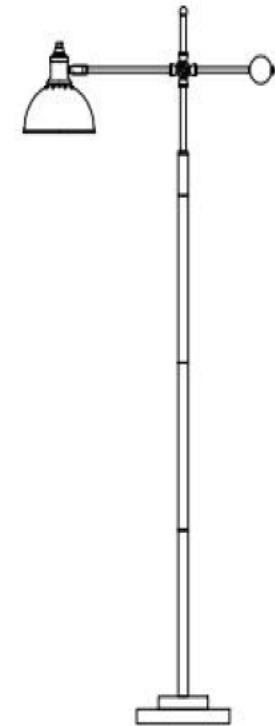

## PREPARATION

Before beginning assembly of product, make sure all parts are present. Compare parts with package contents list and hardware contents list. If any part is missing or damaged, do not attempt to assemble the product.

Estimated Assembly Time: 15 minutes.

PLEASE USE ON/OFF TYPE "A" BULB MAX 40-WATT OR CFL BULB MAX 13-WATT OR LED BULB MAX 4-WATT

THERE IS LED 4-WATT BULB IN THE BOX

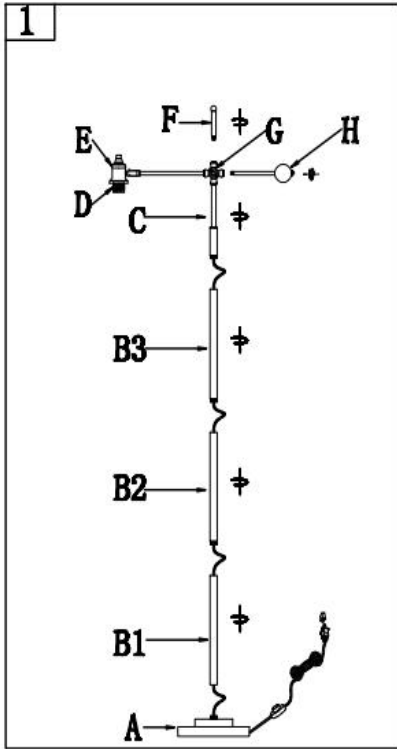

Step 1

Make sure all parts could be aligned before assemble

Unpack all parts from cartons carefully.

Check and make sure all parts are present.

Insert the Lamp Body(B1) into the Lamp Base(A )

Insert the Lamp Body(B2) into the Lamp Body (B1 ),

Insert the Lamp Body(B3) into the Lamp Body (B2 )

Insert the steel tube 1(C) into the Lamp Body (B3 )

Insert the steel tube 2(F) and the steel tube 3(H) into Rotary connector (G )

**ENJOY YOUR LAMP**

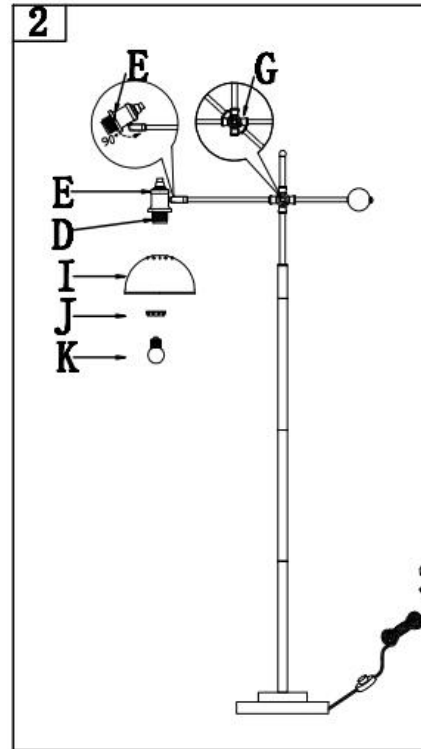

Step 2

Put the shade(I) on the Socket(D),

Then tighten J(Out ring)on theSocket(D)

Insert the bulb(H) into the socket(D).

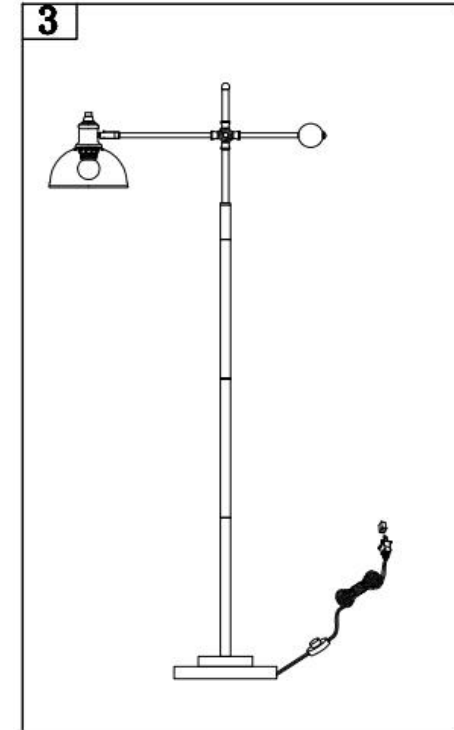

Step 3

Put the light on a level surface to check if everything is stable.