

ASSEMBLY INSTRUCTION

DINING CHAIR

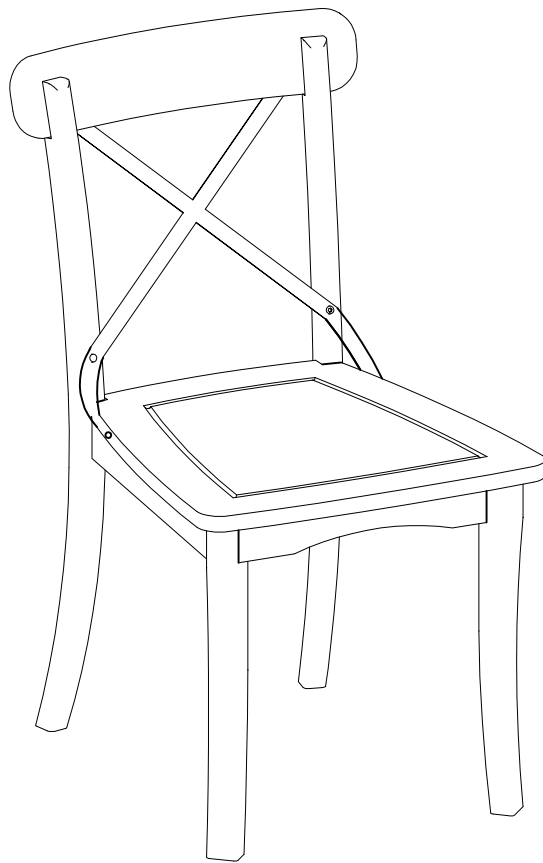







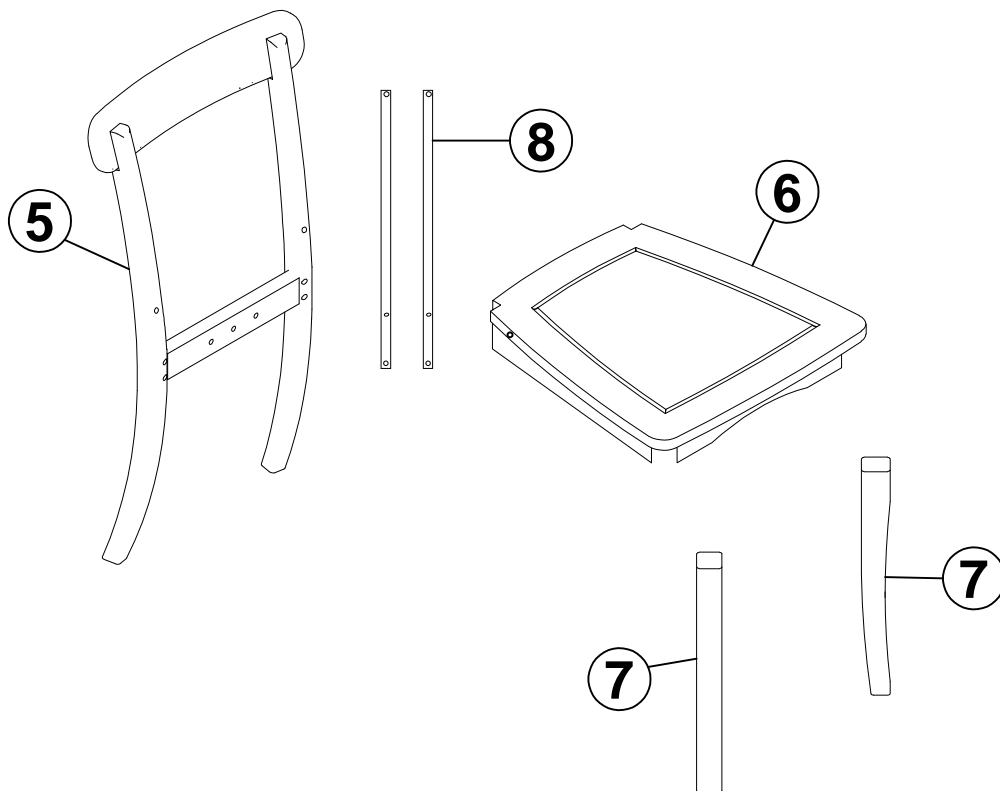

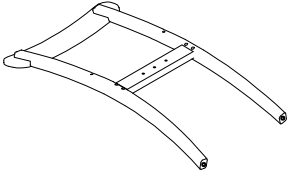
N715P198007

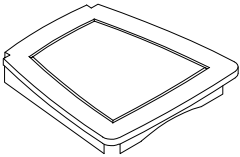
IMPORTANT NOTE :

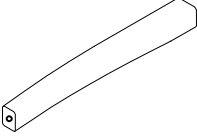

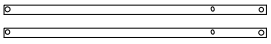

- ① PLACE ALL PARTS ON A CLEAN AND SMOOTH SURFACE SUCH AS A RUG OR CARPET TO AVOID THE PARTS FROM BEING SCRATCHED.
- ② BEFORE YOU BEGIN , KINDLY FOLLOW THE ASSEMBLY INSTRUCTIONS STEP BY STEP.
- ③ DO NOT TIGHTEN ALL SCREWS AND BOLTS UNTIL THE CHAIR IS FULLY SET-UP

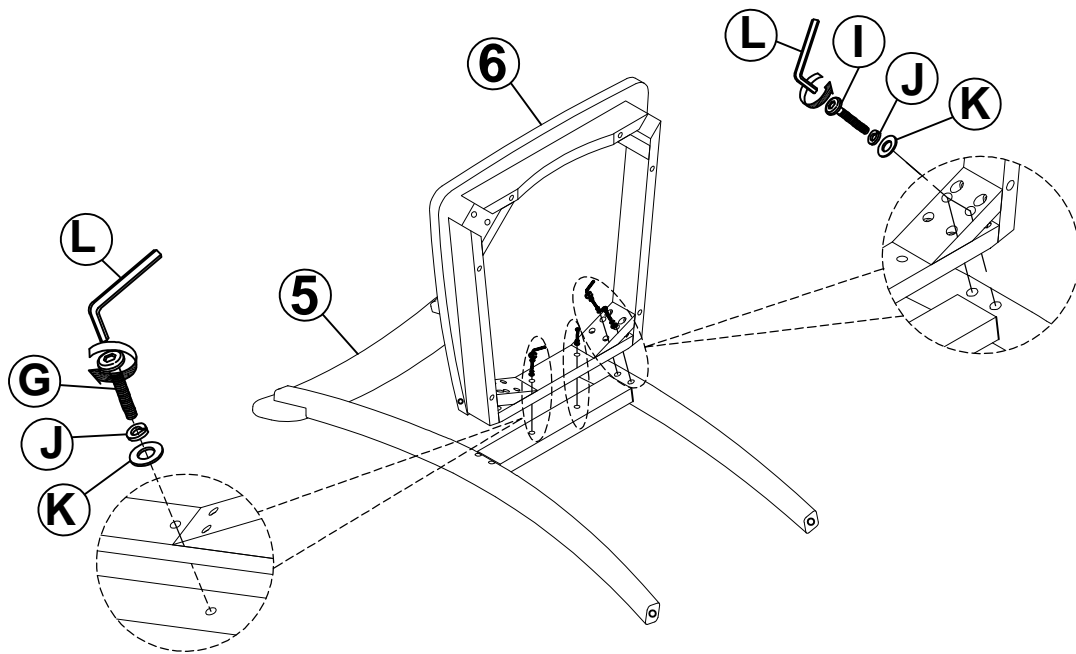

Part List For One Chair		HARDWARE LIST	
5  SIDE CHAIR(1pc)		F  Ø1/4" x 20mm BOLT (6pcs)	
		G  Ø1/4" x 40mm BOLT (2pcs)	
6  SEAT FRAME (1pc)		H  Ø1/4" x 60mm BOLT (4pcs)	
		I  Ø1/4" x 75mm BOLT (4pcs)	
7  LEG (2pcs)		J  Ø1/4"x11mm SPRING WASHER (10pcs)	
		K  Ø1/4"x19mm FLAT WASHER (10pcs)	
8  METAL (2pcs)		L  4 mm ALLENKEY (1pc)	





Step 1

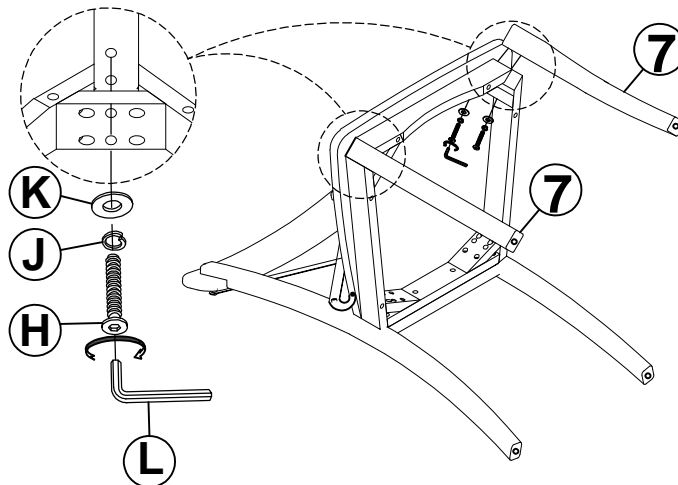

G	Ø1/4"x40		2PCS	J	Ø1/4"x13		6PCS
I	Ø1/4"x75		4PCS	K	Ø1/4"x19		6PCS
L	4 x 58		1PC				

Step 2



H	Ø1/4"x60		4PCS	K	Ø1/4"x19		4PCS
J	Ø1/4"x13		4PCS	L	4 x 58		1PC

Step 3

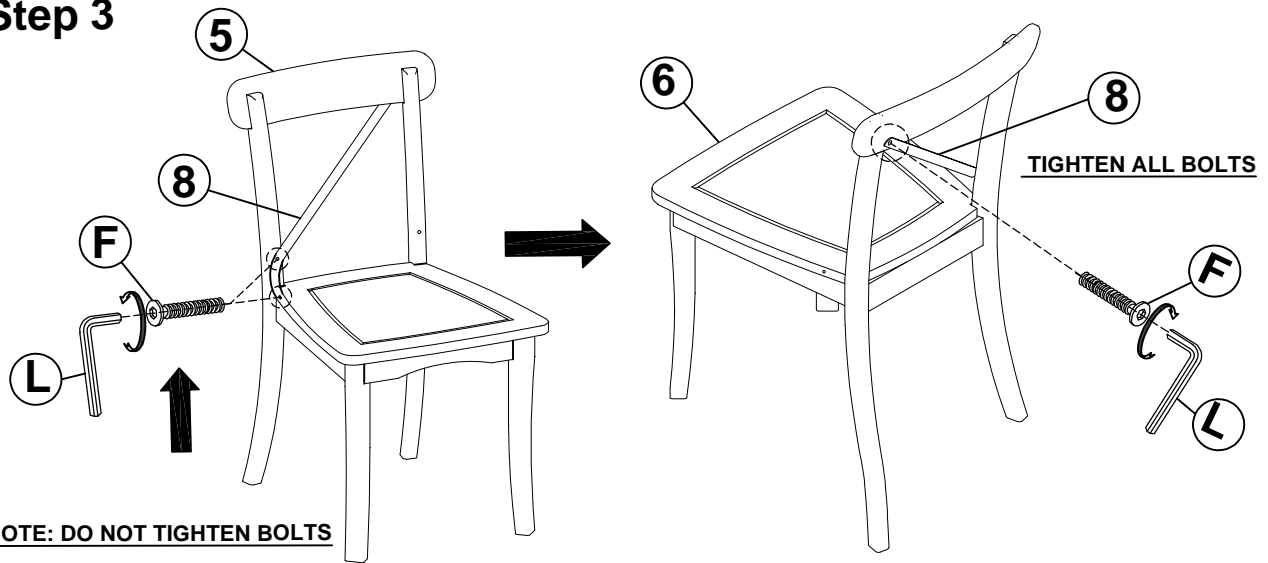



NOTE: DO NOT TIGHTEN BOLTS

F	Ø1/4"x20		3PCS	L	4 x 58		1PC
----------	----------	---	------	----------	--------	---	-----

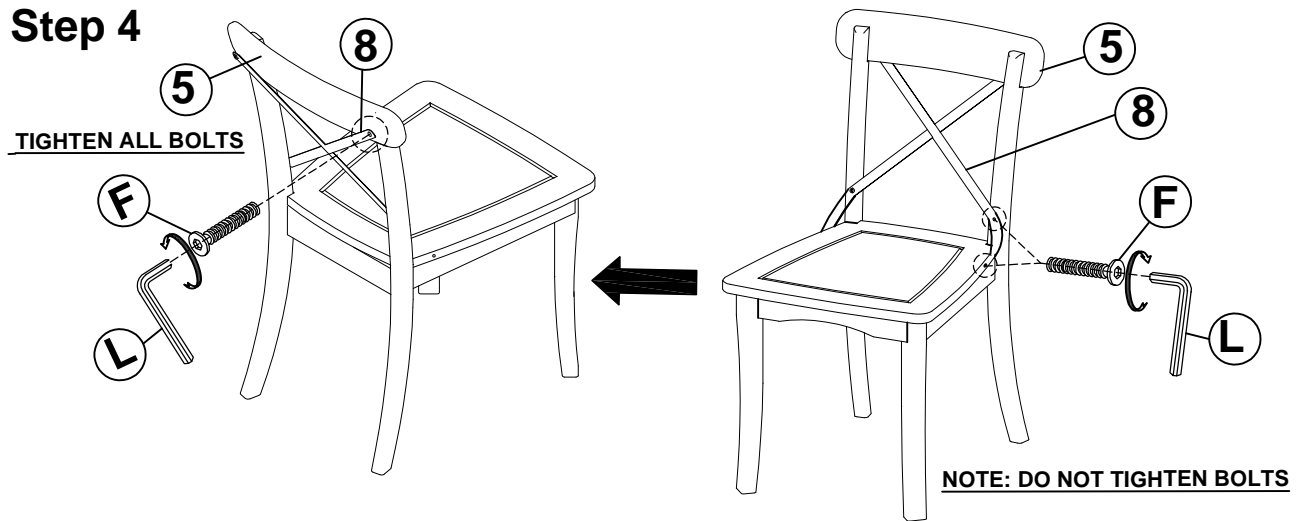
Step 4



F	Ø1/4"x20		3PCS	L	4 x 58		1PC
----------	----------	---	------	----------	--------	---	-----

COMPLETE

