

ASSEMBLY INSTRUCTIONS

QUEEN

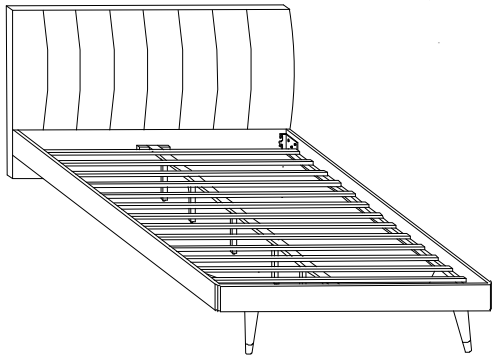

+ Parts Included

① Headboard & Footboard
(1 of pc)

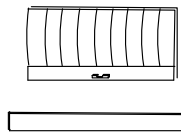

② Side Rail
(2 of pcs)

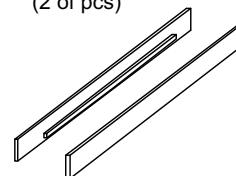

③ Bed Leg
(2 of pcs)



④ Corner Block
(2 of pcs)

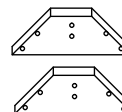

⑤ Support Leg
(5 of pcs)

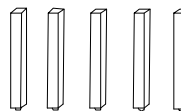

⑥ Center Rail
(1 of pc)

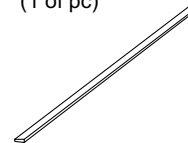

⑦ Slat
(13 of pcs)



⑧ Wood Support
(1 of pcs)



+ Do Not Use Power Tools



+ Suggested Adults

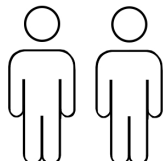

NOTE:

- 1 Read instructions cover to cover.
- 2 Save all packaging until assembly is completed.

1 IMPORTANT SAFETY INFORMATION

Do not assemble the product if any of the following parts arrived damaged:

- Part # - Side Rails
- Part # - Center Support Bar
- Part # - Support Legs
- Part # - Slats

2 IMPORTANT ASSEMBLY INFORMATION

Assembly Step Ensure the side rail bracket is fully hooked onto bolt loosely threaded with both washers on the **OUTSIDE** of the bracket first, then proceed to fully tightening all 4 corners.

+ Hardware Included

A JCBC
M6x50mm
(10 of pcs)



B JCBC
M6x60mm
(5 of pcs)



C Flat Washer
M6
(10 of pcs)



D JCBB
M8x50mm
(4 of pcs)



E JCBB
M8x16mm
(8 of pcs)



F Flat Washer
M8
(4 of pcs)



G CSK
M4x30mm
(26 of pcs)

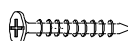

H Adjuster Screw
(5 of pcs)



I JCBC
M6x30mm
(2 of pcs)



J Allen Key M4
(1 of pc)



K Allen Key
(1 of pc)



ASSEMBLY INSTRUCTIONS

QUEEN

