

# MBS106



Thank you for choosing this furniture.

**BEFORE YOU START ASSEMBLY** please store the carton at room temperature for 48 hours or more so the contents can acclimatise.

**PLEASE RETAIN ALL PACKING UNTIL YOU HAVE COMPLETED ASSEMBLY.**

Information about your Furniture.

This furniture range has been manufactured from coated metal.

Caring for your furniture.

Extreme temperature can affect your furniture, please avoid placing close to radiators or other sources of heat.

Not suitable for use in damp or humid environments.

Please avoid exposing your furniture to continued bright sunlight as this may affect the colour.

Any fluid spills should be removed as quickly as possible.

Always lift your furniture when moving as dragging may cause damage to your furniture or flooring.

After care.

Regularly clean surfaces with a dry cloth.

When necessary a slightly dampened cloth can be used to remove stains or spills but ensure the furniture is fully dried afterwards.

Any fluid spills should be removed as quickly as possible.

To keep drawers running smoothly we recommend using a household spray polish or silicone curtain track spray on the drawer runner tracks.

Please do not use any wax based products, detergents or chemicals on this furniture.

## PARTS LIST

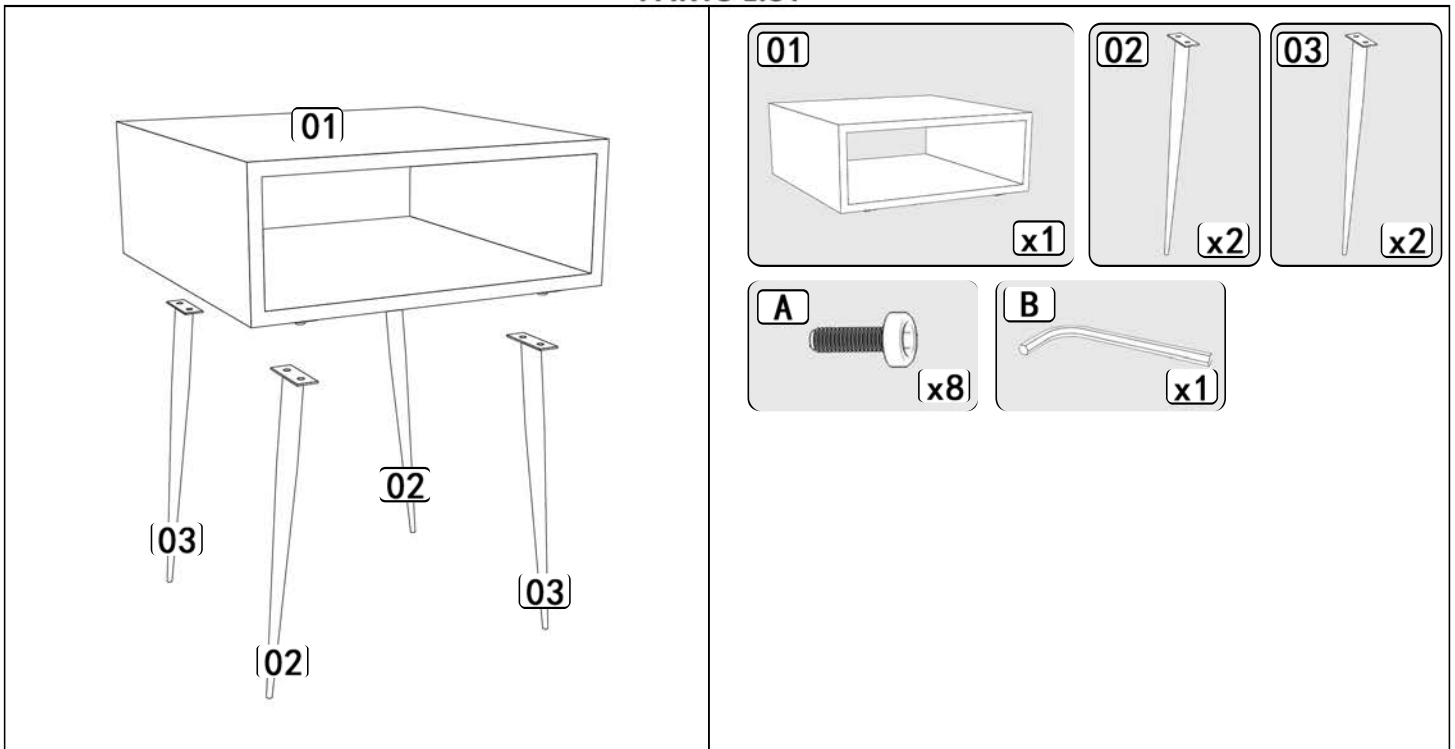

### **BEFORE YOU START ASSEMBLY**

Please check that you have all the correct parts and fittings as detailed on the assembly instructions.

### **FOR DAMAGED/REPLACEMENT PARTS**

Please visit

[www.coreproducts.co.uk/parts](http://www.coreproducts.co.uk/parts)

Batch  
Number

**EVER7459**

**PLEASE RETAIN THIS LEAFLET ALONG WITH YOUR DELIVERY  
NOTE / RECEIPT AND ALLEN KEY FOR FUTURE USE OR REFERENCE.**



01

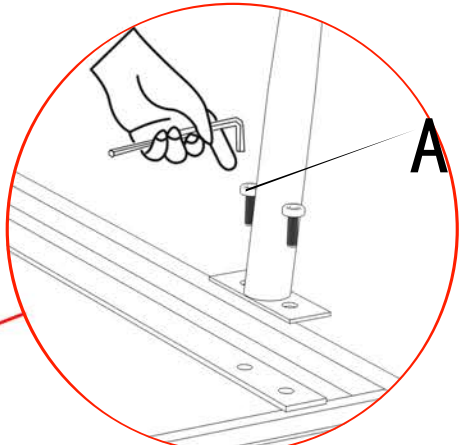
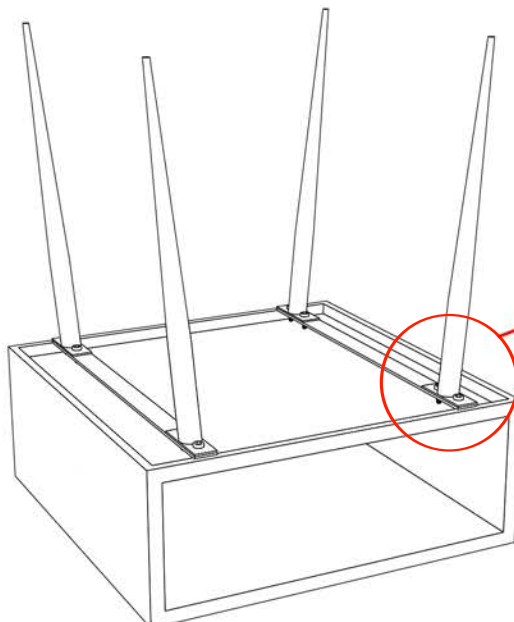
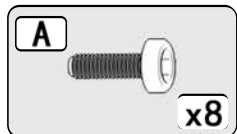
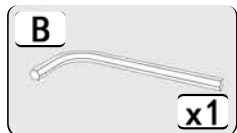

To avoid damage to your furniture during assembly please build on a soft clean surface such as the inside of the cardboard box.

02



**IMPORTANT NOTICE**

We recommend that if this furniture is used in a location where there is a risk of tipping, especially environments with children or uneven floors that the furniture is securely attached to your wall using appropriate fittings (not supplied).

**PLEASE RETAIN THE ALLEN KEY AND TIGHTEN BOLTS ON LEGS WHEN NECESSARY.**