

■ Dining Chair

ASSEMBLY INSTRUCTION



SKU:810B

Dear customer, Thank you very much for buying our items. Please read the assembly instruction carefully before assembly.

Notices:

- Verify that all parts are present and in good condition before assembly.
- Put the chair on a clean flat surface.
- Please tighten the screws to about 80% for the first step; Then, sit with caution on the chair to adjust the balance; Finally, tighten all the screws to 100%.
- If you find that is unlevel after assembly, you can use adjustable pegs to keep four legs level.

Contact us

If there are installation problems, damage, missing parts, or any questions and concerns, please contact the shop where you bought it so we can make things right.

If the product is damaged, please send the following information:

- Photos that show the reason for your claim/damage.
- Photos of the packaging (inside and outside).

Thank you very much for your support!

Package Contents

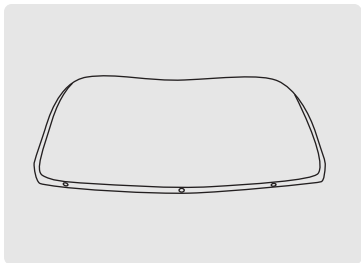

Backrest

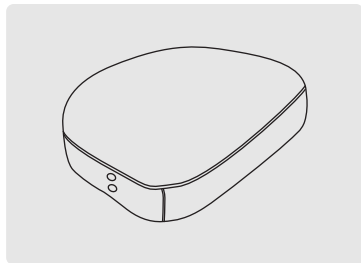

Seat Cushion

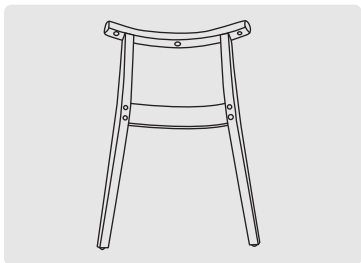

Wood Frame

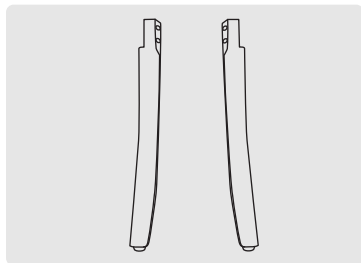

Front Legs

A × 8



Flat Washer

B × 8



Lock Washer

C × 1

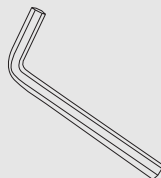

Allen key

D × 3



M6x45mm
Screws

E × 4

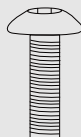

M8*50mm
Screws

F × 4

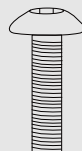

M8x60mm
Screws

Step by Step Guide

1

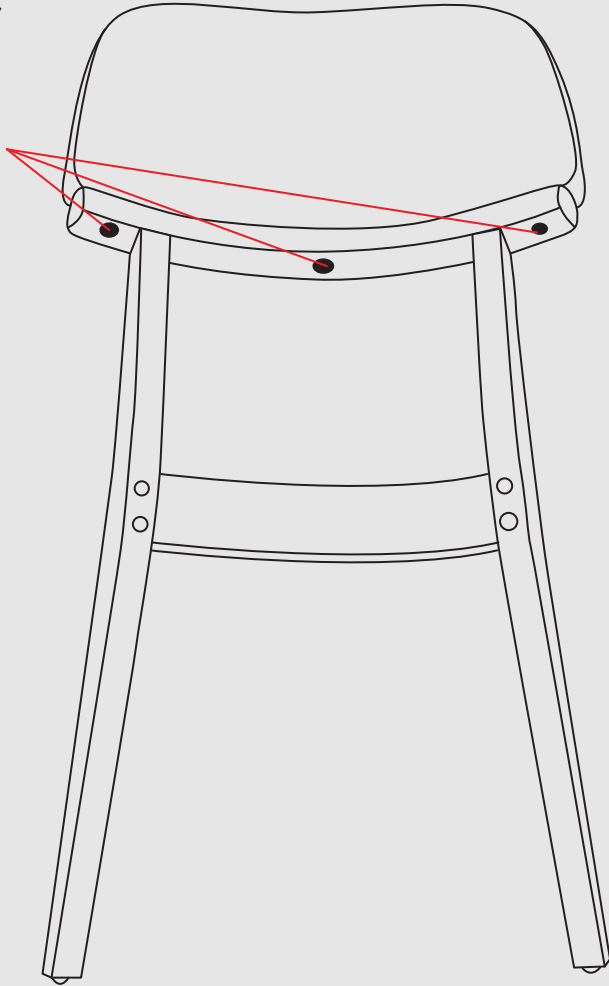
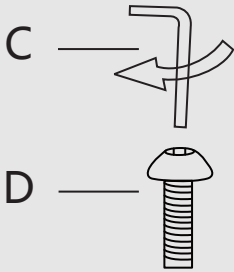

Align the screw holes at the bottom of the backrest to the holes on the top of the wooden frame using screws(D)

Tighten all 3 screws up to 100% at the same time.

Step by Step Guide

2

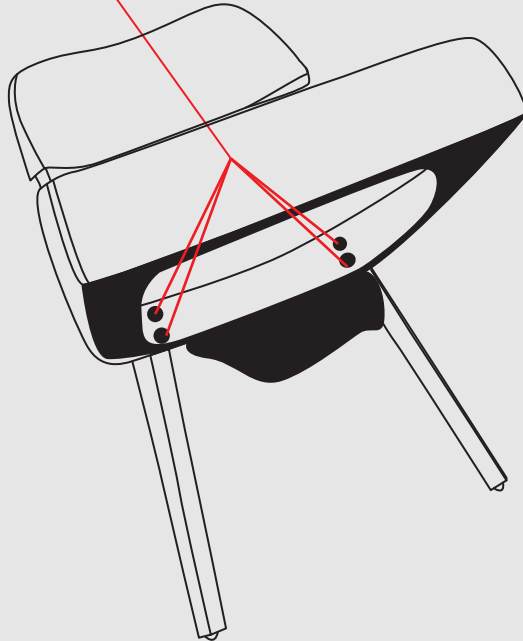
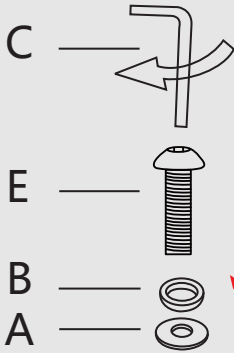

Align the holes in the seat cushion with the screw holes of the wood frame by using screws (E) and washers (#A, B)

Tighten all 4 screws together at the same time.
Just tighten them up to 80%.

Step by Step Guide

3

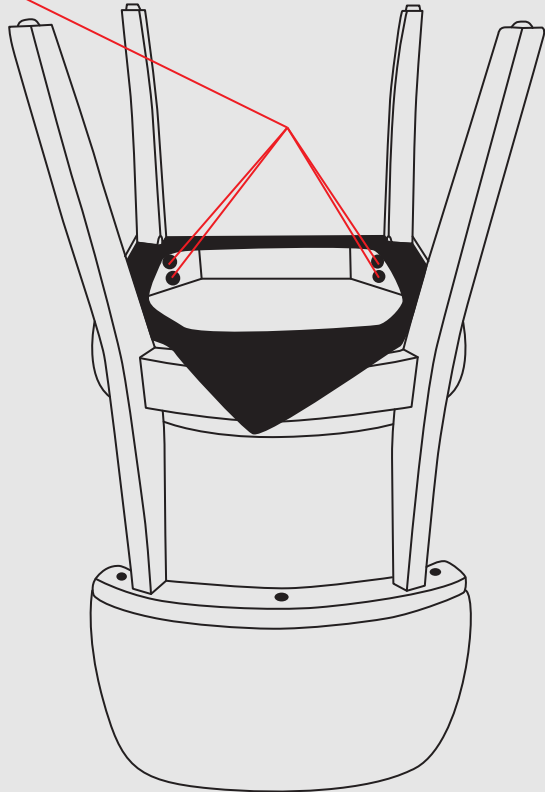
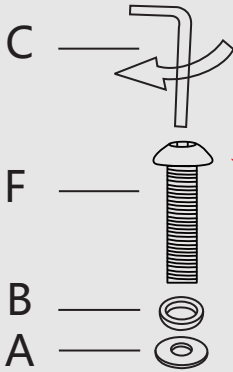

Taking the front leg to align the holes of the seat cushion of the chair by using screw (F) with washers (#A, B)

Tighten all 4 screws together at the same time.
Just tighten them up to 80%.

Step by Step Guide

4

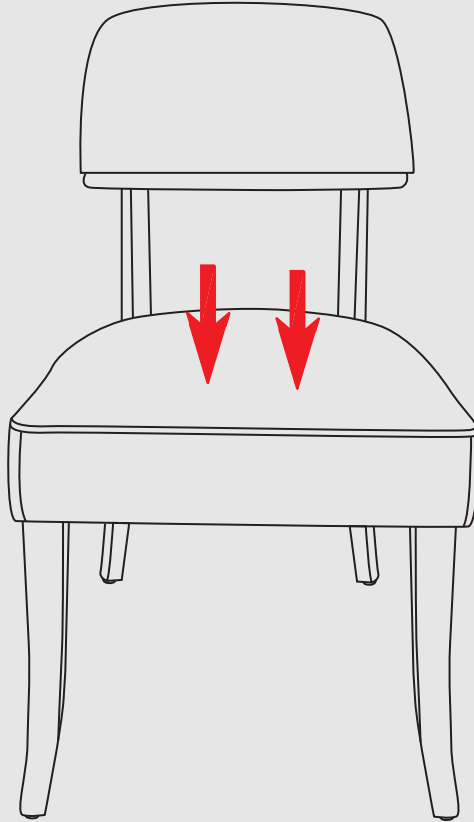

Sit on the chair or please put a heavy object, and check whether the chair is steady or not, then tighten all screws up to 100%.

If the chair are not steady, please check all of the screws are tightened.

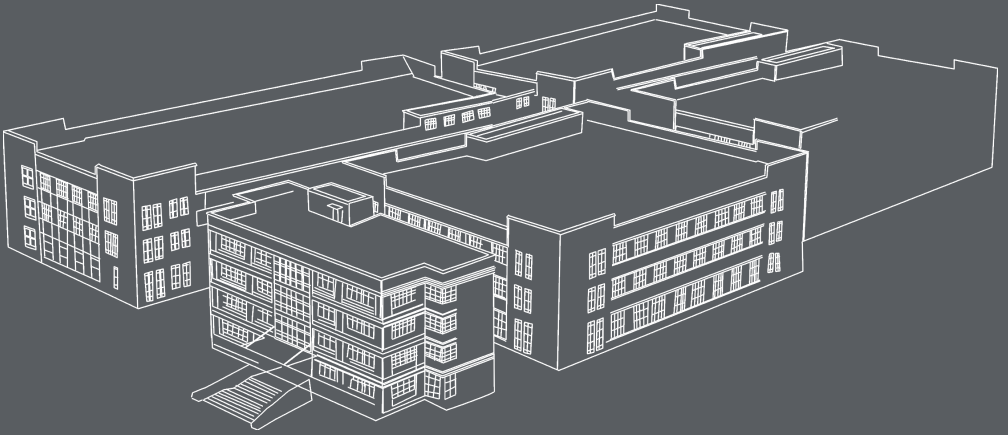

About us

We are a professional manufactory for making and selling dining chairs. In the past 15 years, we have exported millions of chairs to Europe and USA.

We focus on providing you with high-quality products that meet international standards. To ensure timely shipping, we have built large warehouses in California, New York, and Georgia.

Contact us

The fastest way to get more information about the deals!

Email: support@pekkohome.com