

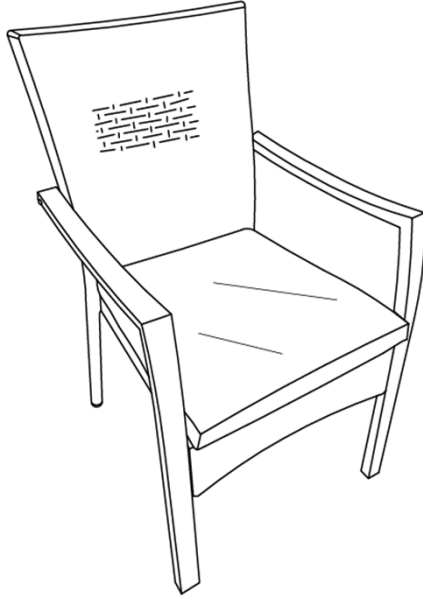

Assembly Instructions

Caution: You must read this before you proceed







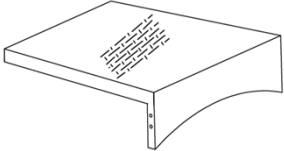
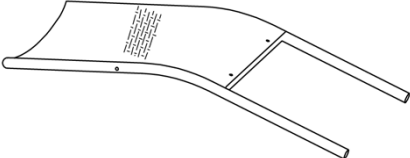

Single Chair

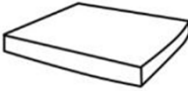

Parts List

Label	Picture	Description	QTY
A		Left Armrest / Leg	1
B		Right Armrest / Leg	1
C		Seat	1
D		Seat Back	1

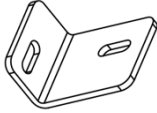
Hardware

Label	Picture	Description	QTY
E		Allen Key	1
F		Bolt (M6*30mm)	5
G		Bolt (M6*40mm)	3
H		Bolt (M6*60mm)	3
I		Washer	13
J		Seat Cushion	1
K		Bolt (M6*20mm)	2
L		Connection	1
M		Connection	1

Assembly Preparation

Before Beginning Assembly:

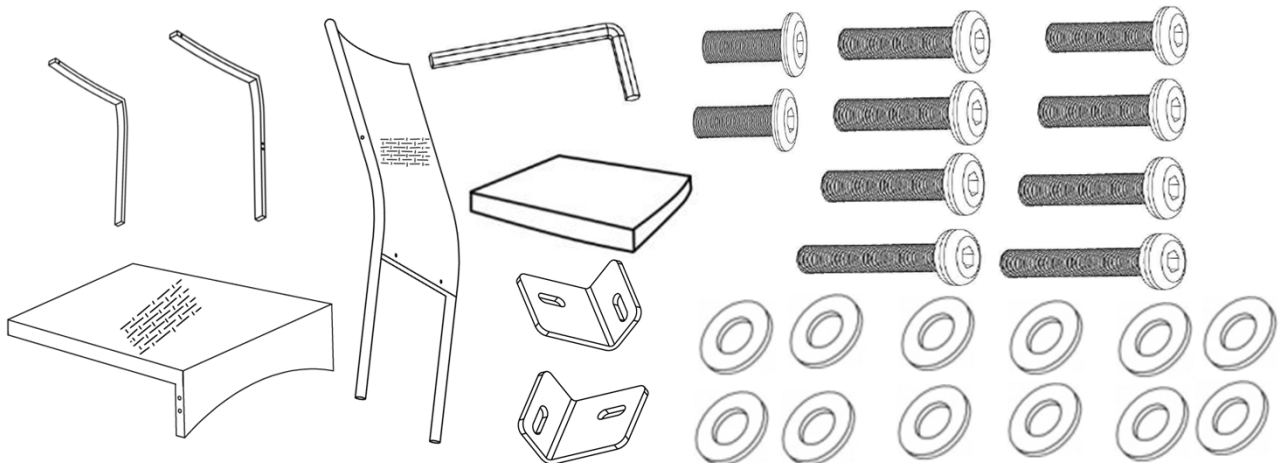

- Read instructions, cover to cover-



- Have 2 adults on hand for assembly-



- Do not assemble on flooring or carpet-



- Assemble on a clean non-marring surface (packing foam)-



- Save all packaging until finished-

Assembly Steps

Step 1

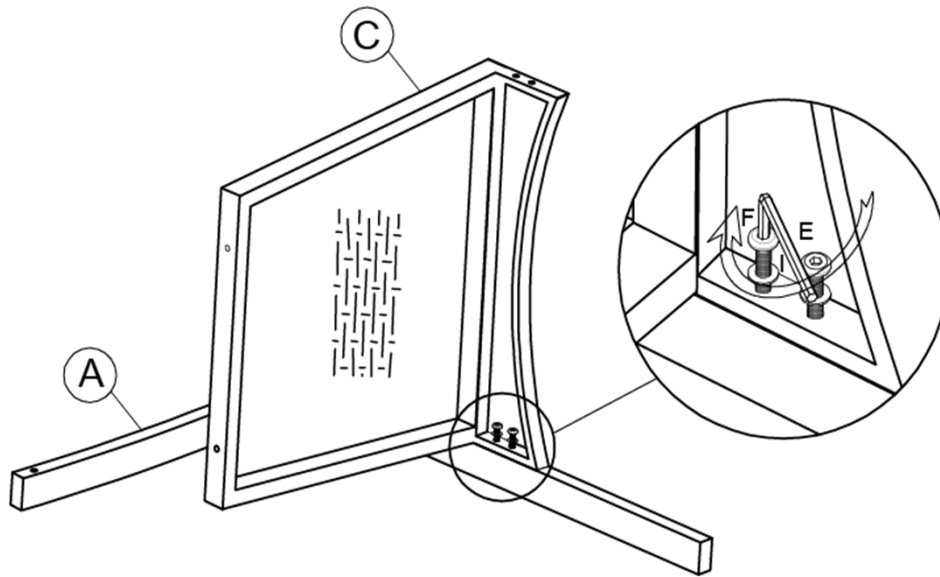

Open the carton and place all the parts on a clean, non-marring surface.

ATTENTION: Occasionally some of the PE Wicker shifts and covers the mounting positions preventing easy assembly.

The PE wicker should never be cut, but moved away from the mounting positions.

Attach Left Armrest / Leg(A) to the Seat(C) using Bolt(F) and Washer(I) with Allen Key(E) as shown in the picture above.

Loosely tighten the Bolts.

Step 2

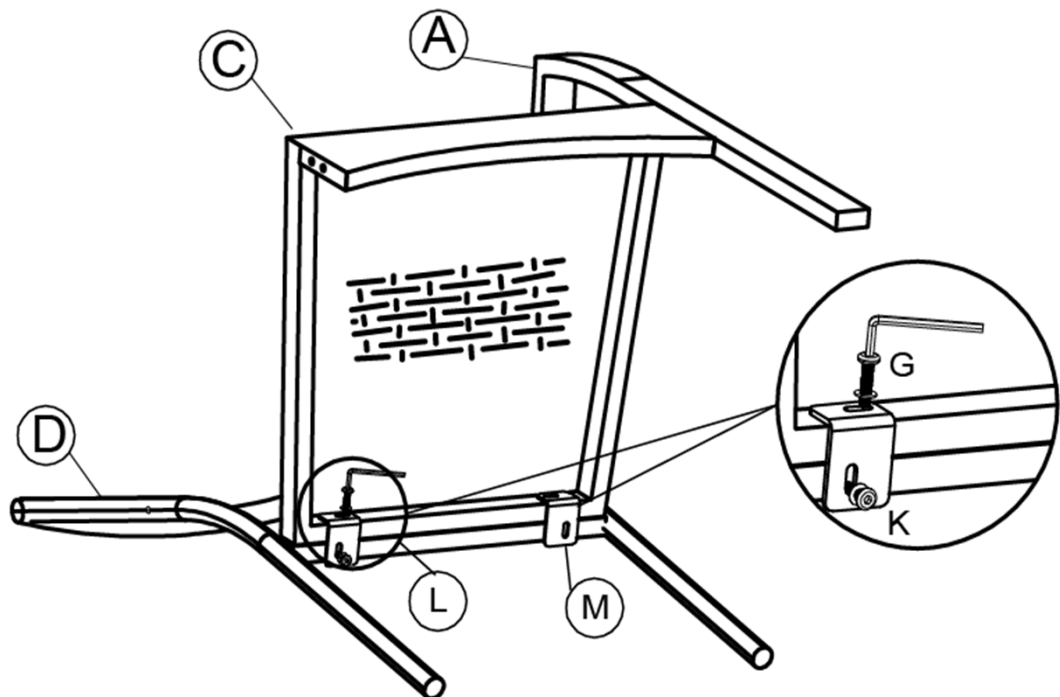

Attach Seat Back(D) to Seat(C) using Washer(I) , Bolt(G&K) & Connection(L&M) with Allen Key(E) as pictured above.

Loosely tighten the Bolts.

Step 3

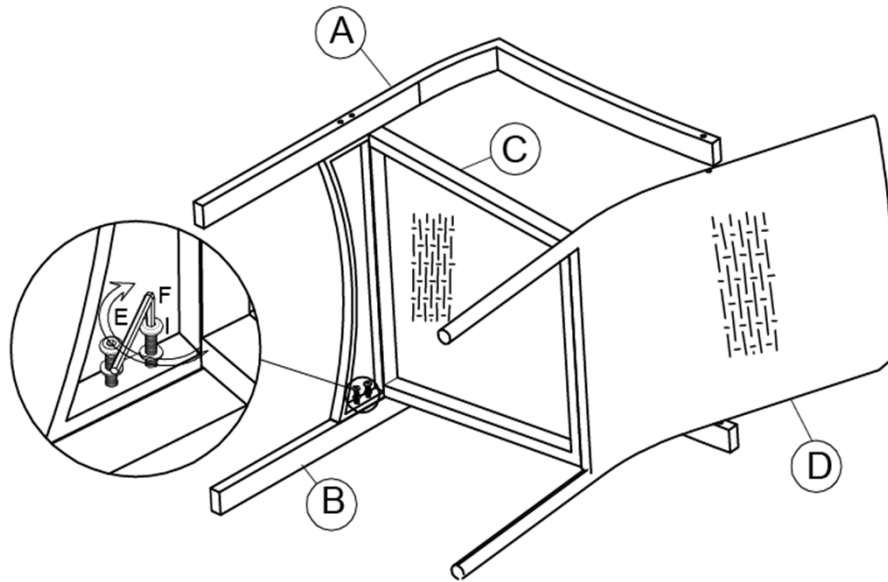

Attach Right Armrest / Leg(B) to Seat(C) using Bolt(F) and Washer(I) with Allen Key(E) as shown in the picture above.

Loosely tighten the Bolts.

Step 4

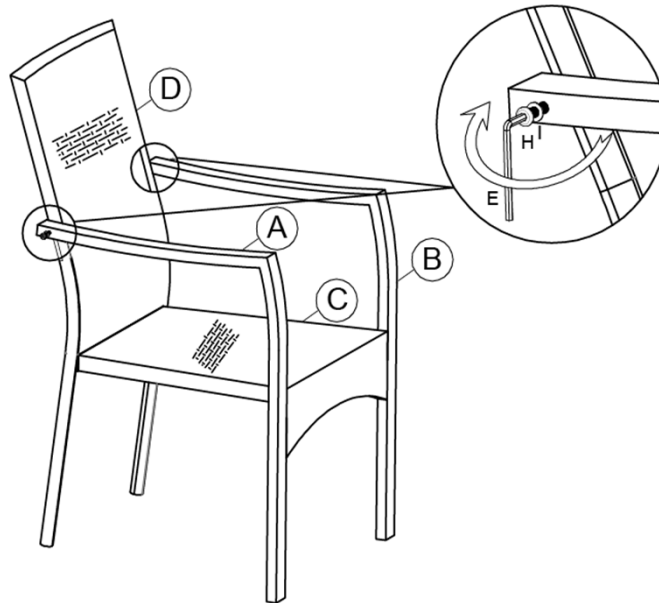

Connect the Chair Legs(A&B) with the Seat Back(D) using Washer(I) and Bolt(H) with Allen Key(E) as pictured above.

Loosely tighten the Bolts.

Step 5

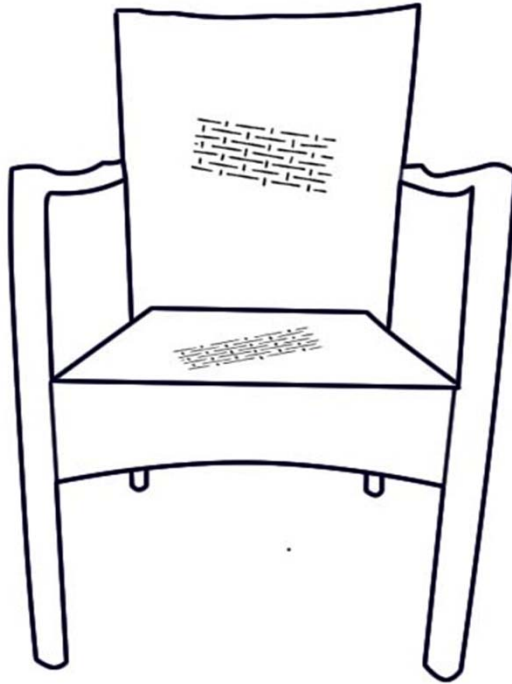

Check for stability and then tighten all Bolts at all joints.

Note: DO NOT fully tighten a Bolt in one go and then move on to the next.

Rather; in a sequential manner, gradually tighten each Bolt until all Bolts are evenly secured.

This methodology will ensure maximum evenness once all Bolts are fully tightened.



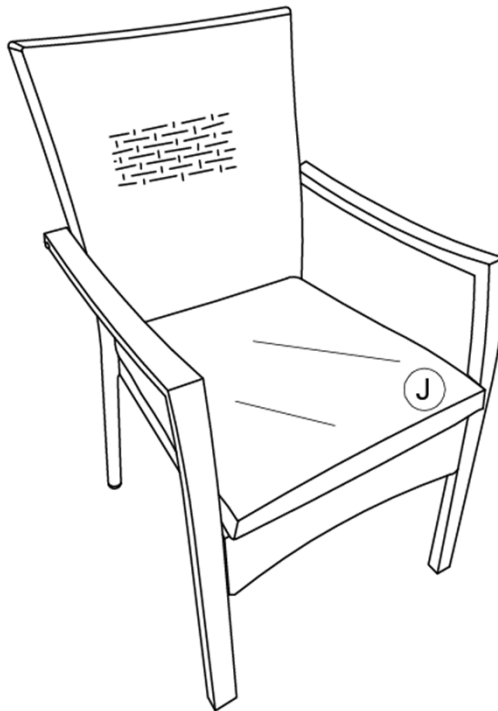

















Step 6



Place the Seat Cushion(J) on the Chair.

Your Chair is ready for use.

Care & Maintenance

-   ● Do not put hot items directly on furniture surface
 -   ● Do not clean furniture with harsh cleansers or polish.
 -   ● To obtain the longest lifespan of your outdoor products, minimizing exposure to direct sunlight is recommended.
 -   ● Children should not climb or jump on the furniture.
 -   ● Do not write on furniture without a padded barrier to protect the surface.
 -   ● To obtain the longest lifespan of your outdoor products, avoid extended and lengthy exposure to rain, snow, and direct sunshine. Whenever possible cover the product and /or place under patio or awnings.
 -   ● Not for commercial use. For residential use only .
 -   ● Stains may be removed with mild soap solution and damp cloth.
 -   ● Keep away from sources of ignition.
-
-   ● Dust and pick-up spills using a clean, non-colored, lint-free cloth .