

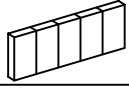









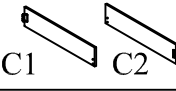







ASSEMBLY INSTRUCTIONS

**NOTE : THIS ITEM NOT RECOMMENDED FOR COMMERCIAL USE
KEEP THIS DOCUMENT FOR REFERENCE IN CASE PARTS ARE NEEDED**

DO NOT TIGHTEN SCREWS UNTIL COMPLETELY ASSEMBLED !!

NO		DESCRIPTION	QTY
A		Headboard	1pc
B		Footboard	1pc
C		Side Rail	4pcs
D		Headboard Legs	2pcs
E		Footboard Legs	2pcs
F		Side Rail Legs	2pcs
G		Side Rail Support Wood	4pcs
H		Slat	4pcs
I		Support Legs	4pcs

NO		DESCRIPTION	QTY
1		JCBB M8 x 20	8pcs
2		JCBC M6 x 30	20pcs
3		JCBC M6 x 35	4pcs
4		JCBC M6 x 50	8pcs
5		Wrench Key 100mm	1pc
6		Wrench Key 70mm	1pc
7		CSK Screw 32mm	8pcs
8		Spring Washers	6pcs
9		Flat Washers	8pcs
10		Adjuster	4pcs

ASSEMBLY INSTRUCTIONS

STEP 1 :

Unzip the black non-woven fabric on the back of headboard and take out all the parts.

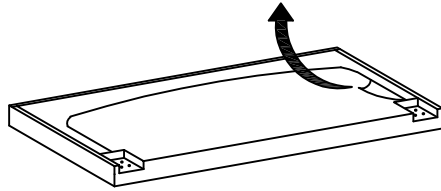

Attention: Re-zip the black non-woven fabric after you take out the parts.

STEP 2 :

Attach the legs to the headboard and footboard as shown.

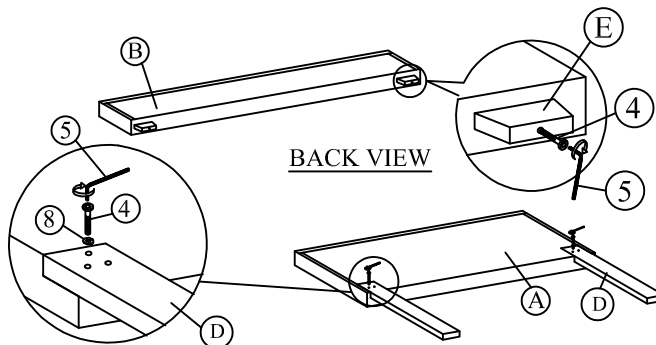

STEP 3 :

Attach the JCBB Bolt to the headboard bracket and footboard bracket.

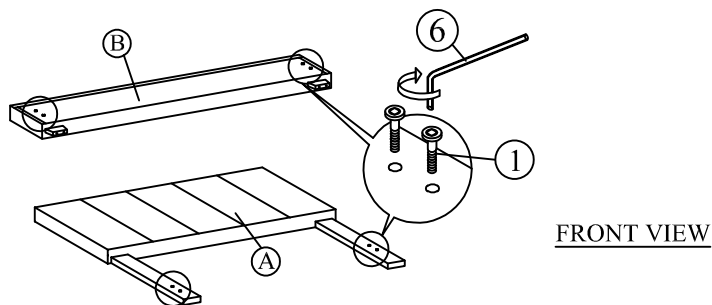

ASSEMBLY INSTRUCTIONS

STEP 4 :

Attach the side rail support wood (G) to the side rail (C).

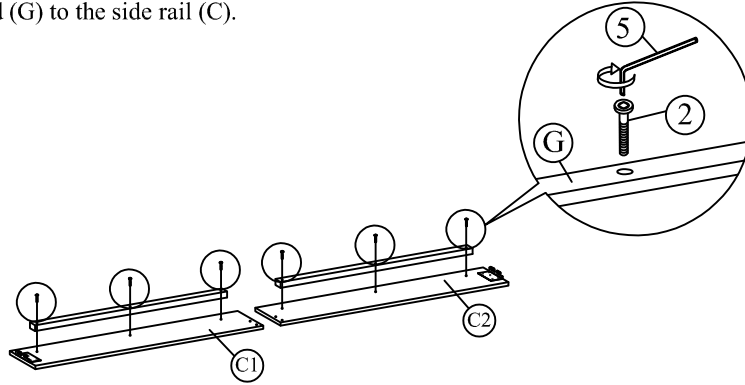

STEP 5 :

Attach the side rail leg (F) to the side rail (C).

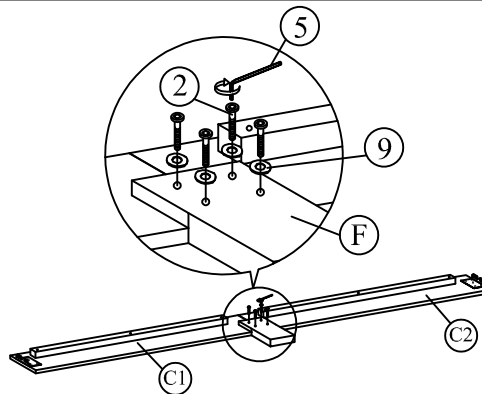

STEP 6 :

Attach side rail (C) to headboard (A) and footboard (B) by pushing the bracket down to fit it.

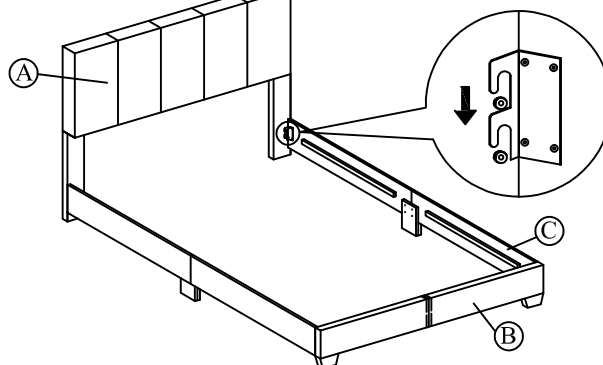

ASSEMBLY INSTRUCTIONS

STEP 7 :

Attach the support legs (I) to the slats (H).

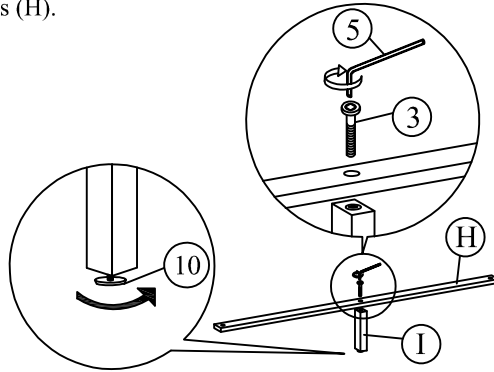

STEP 8 :

Tighten the 4 Corner with Allen Key (6). Install the bed slats to side rail. Tighten the slats with CSK screw. The distance of the slats should be sufficient to obtain desirable bed stability.

