

## CARE AND MAINTENANCE











Store outdoor furniture indoors or cover well when not in use.  
 Remove wicker furniture from standing water. Dust regularly with small brush or vacuum  
 Spills should be taken care of immediately before they harden or stain with a slightly dampened sponge.

## NOTICE

- \* Please make sure that you have all parts indicated before you begin assembly of this item
- \* This item should be assembled on a soft surface to prevent scratching the finish during assembly
- \* This item may require periodic tightening

Weight Capacity : 275 lbs (single seat)  
 550 lbs (towperson seat)  
 Warning : Do not stand on table/chair/bench  
 Warning : Do not over torque bolts/screws

## Part List and Hardware List

PIECE	DESCRIPTION	PICTURE	QUANTITY
A	Bench Seat Frame		1X
B	Leg Chair		12X
C	Bench Seat Cushion		1X
D	Chair Seat Frame		2X
E	Chair Seat Cushion		2X
F	Table Frame		1X
I	Leg Table		4X
G	Glass		1X
HW1	Socket Screw 6 x 0.5 x 15 mm		64X
HW2	Flat Washer		64X
HW3	Allen Key		3X



### Product Dimensions:

25.98" W x 24.01" D x 32.28" H (Chair)  
 55.11" W x 24.01" D x 32.28" H (Bench)  
 35.43" W x 19.68" D x 15.35" H (Table)

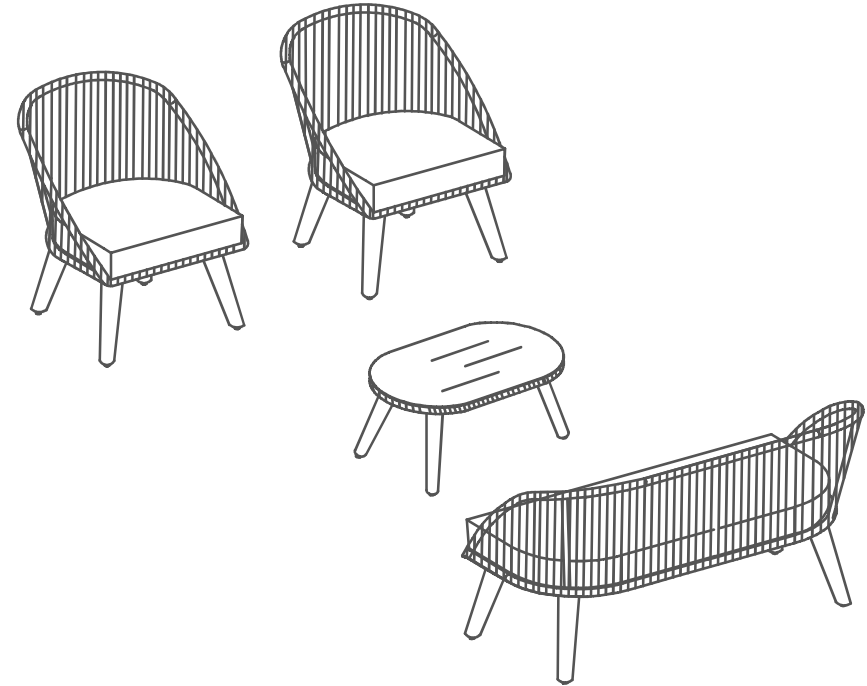





## CARE AND MAINTENANCE

Store outdoor furniture indoors or cover well when not in use.  
Remove wicker furniture from standing water. Dust regularly with small brush or vacuum  
Spills should be taken care of immediately before they harden or stain with a slightly dampened sponge.

## NOTICE

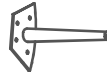
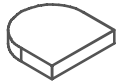
- \* Please make sure that you have all parts indicated before you begin assembly of this item
- \* This item should be assembled on a soft surface to prevent scratching the finish during assembly
- \* This item may require periodic tightening

## Part List and Hardware List

PIECE	DESCRIPTION	PICTURE	QUANTITY
D	Chair Seat Frame		2X
B	Leg Chair		8X
E	Chair Seat Cushion		2X
HW1	Socket Screw 6 x 0.5 x 15 mm		32X
HW2	Flat Washer		32X
HW3	Allen Key		1X

Weight Capacity : 275 lbs

Warning : Do not stand on Bench

Warning : Do not over torque bolts/screws



Product Dimensions: 25.98" W x 24.01" D x 32.28" H

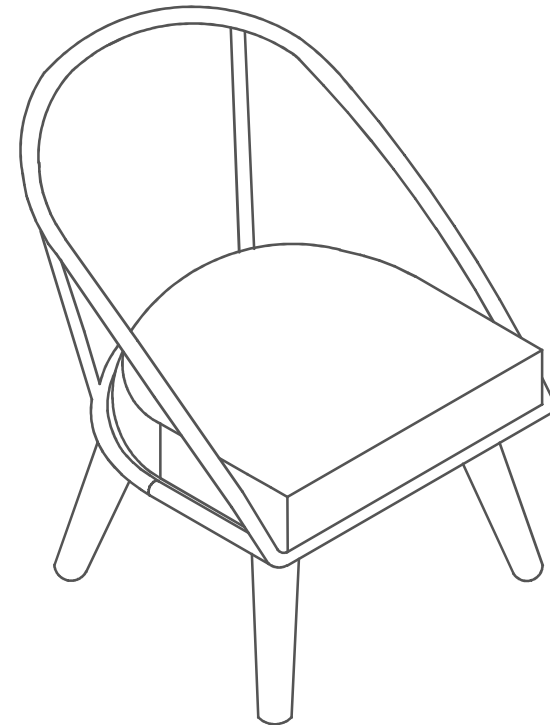

## PREPARATION

Before beginning assembly of product, make sure all parts are present. Compare parts with package contents list and hardware contents list.

If any part is missing or damaged, do not attempt to assemble the product.

Estimated Assembly Time: 10 minutes.

Tools Required for Assembly (included): Allen Key

1

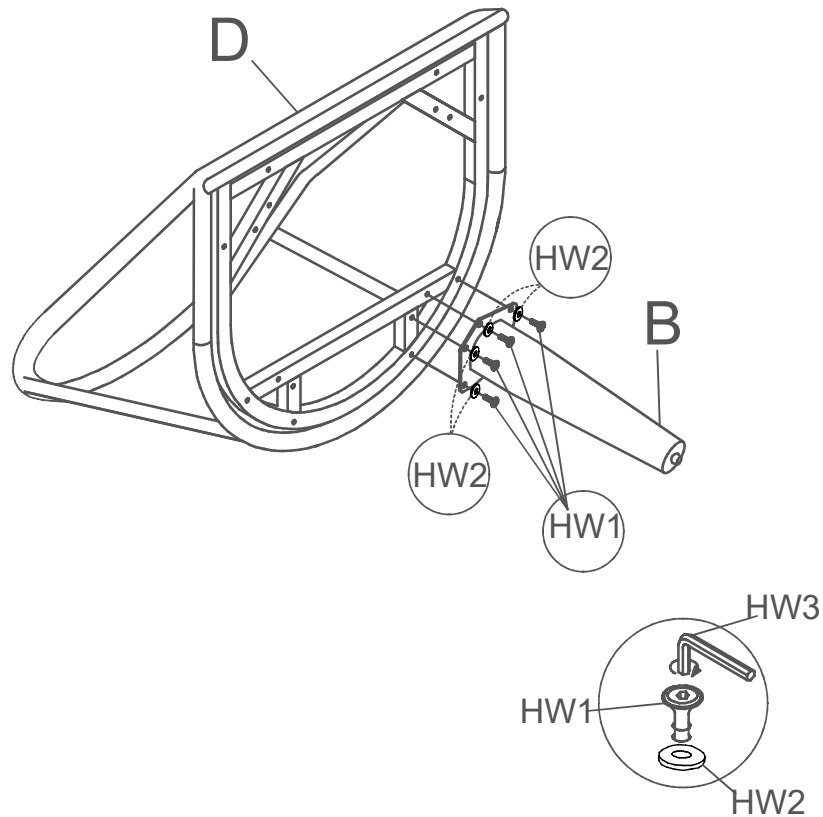

Step 1  
Attach Leg Chair (B) to Chair Seat Frame (D). Use Bolt (HW1) tighten with Allen Key (HW3).

2

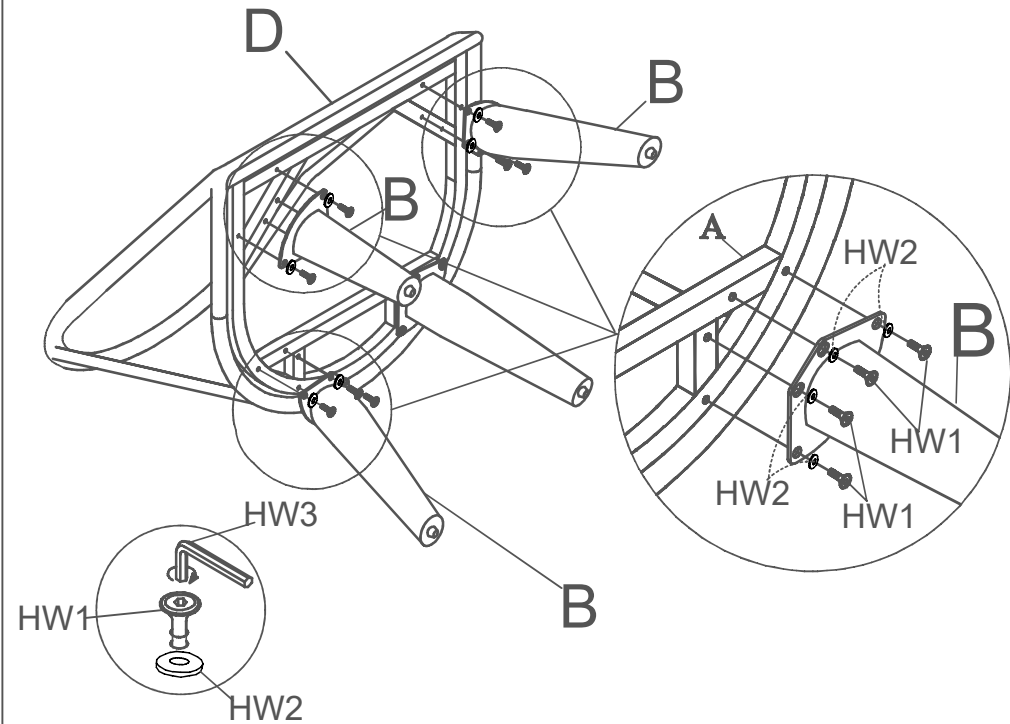

Step 2  
Like step 1 using Leg Chair (B) is inserted into the Chair Seat Frame (D). Use Bolt (HW1) tighten with Allen Key (HW3).

## PREPARATION

Before beginning assembly of product, make sure all parts are present. Compare parts with package contents list and hardware contents list.

If any part is missing or damaged, do not attempt to assemble the product.

Estimated Assembly Time: 10 minutes.

Tools Required for Assembly (included): Allen Key

3

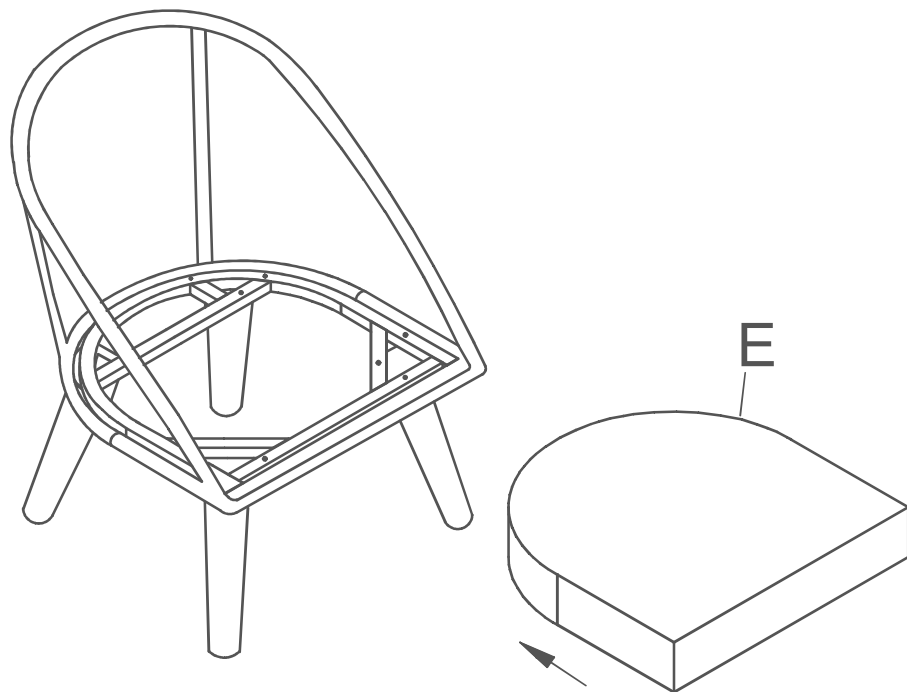

### Step 3

Put Chair Seat Cushion (E) on the Chair. The Chair is ready to be used.

4

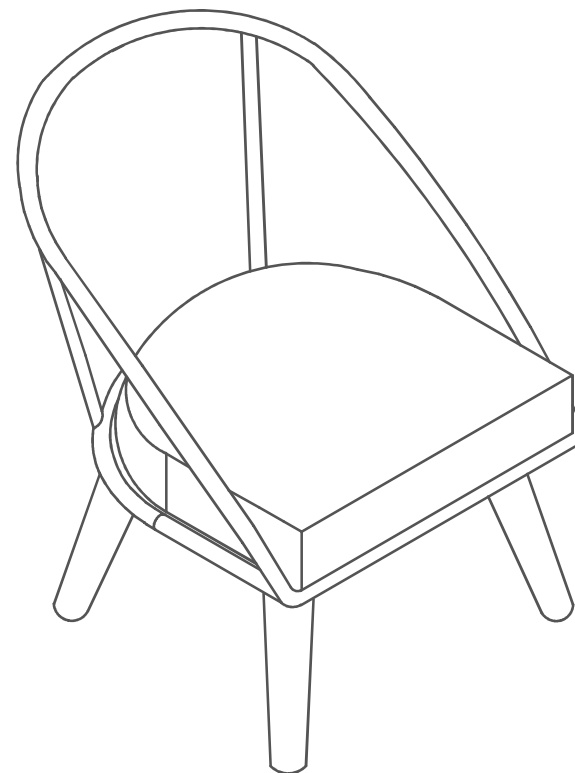

### Step 4

Caution: This Chair can only be used on a flat, level surface