

Shower Door  
1/4" glass (6mm)

Installation Dimensions :  
31" - 32" W x 55" H

## S9301-A2 INSTALLATION GUIDE

### CAUTION:

To reduce the risk of breakage, keep corner protectors on glass while installing. Keep corner protectors for use in case future adjustments are needed.

Read the instructions carefully before installation.

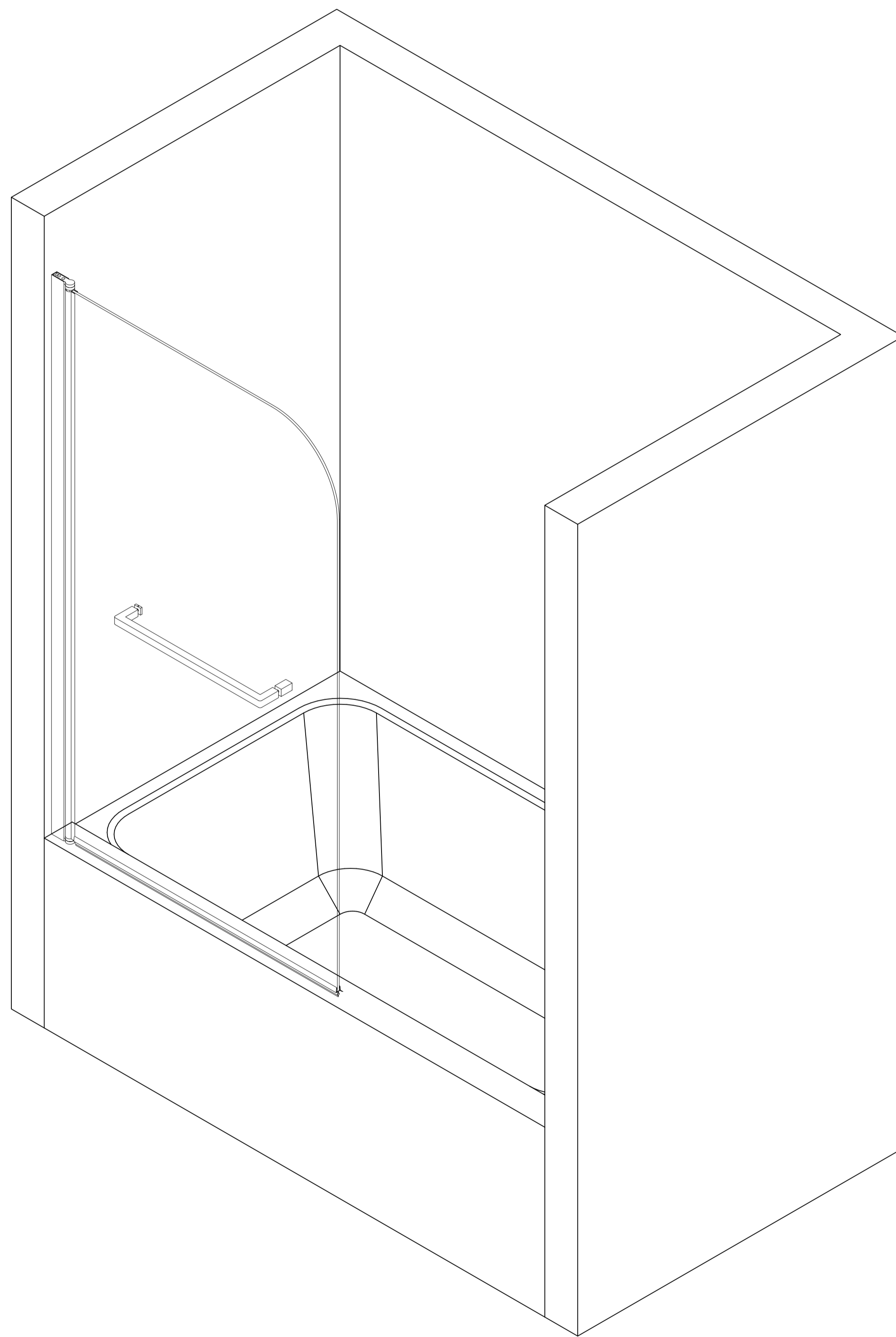

installation video

**Please spend two minutes watching the installation video to save half an hour of installation time**





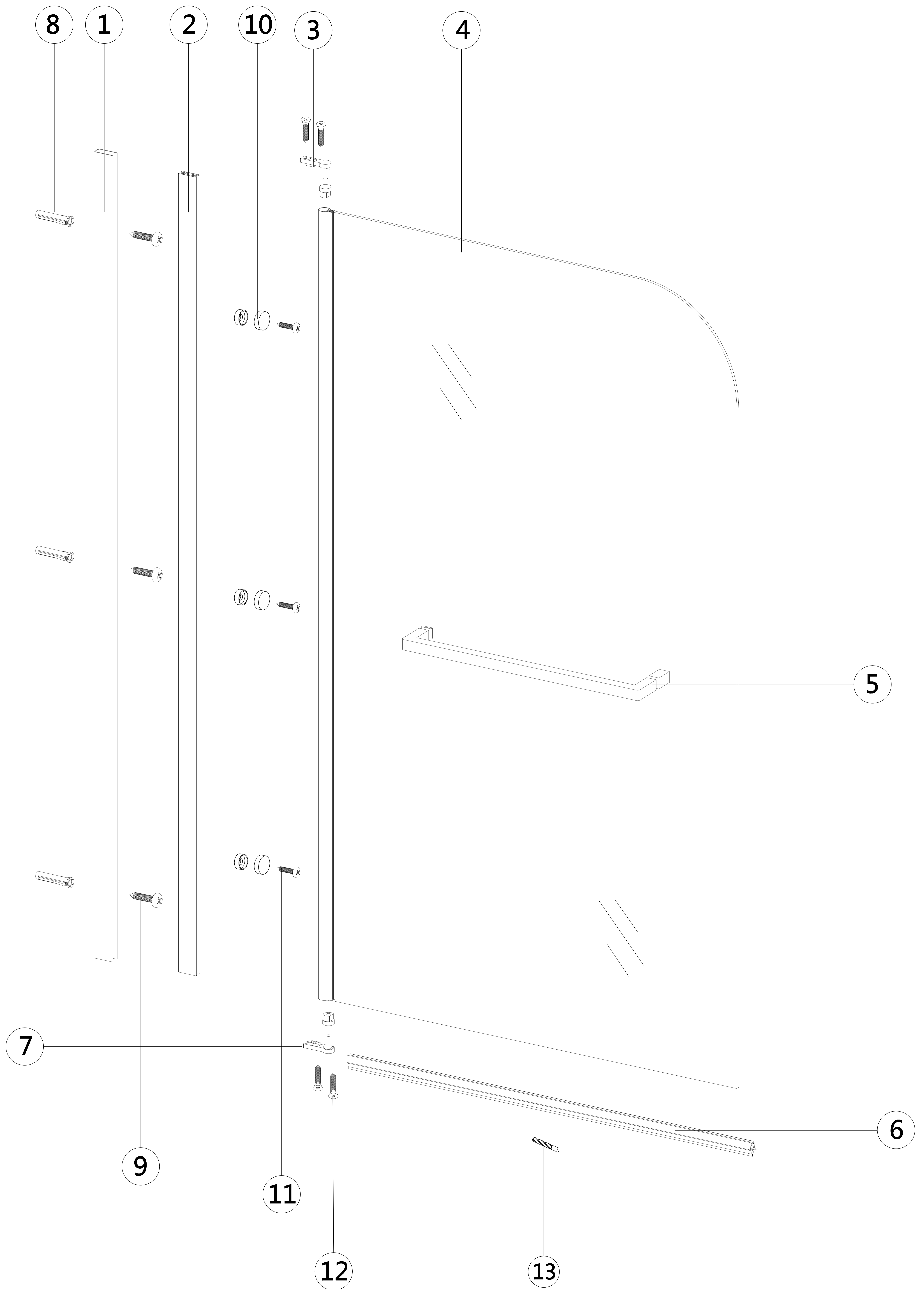









# Detailed Diagram

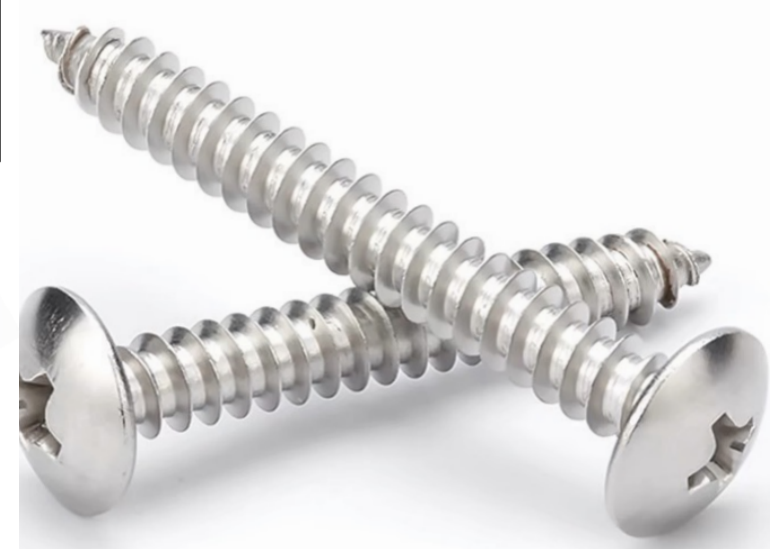

# PART LIST

Check all parts according to the list before assembly

1		2		3		4		5	
Swivel wall material (1 pc)		Fixed shaft material (1 pc)		Top lifting shaft (1 pc)		Active panel (1 pc)		Handle (1 pc)	
6		7		8		9		10	
Waterproof strip (1 pc)		bottom lifting shaft (1 pc)		Wall anchor Ø6 (4 pcs)		ST4.0X40 Screws(7pcs)		decorative cover (4 pcs)	
11		12		13					
ST4.0X8 Screws (4 pcs)		ST4.0X20 Screws (4 pcs)		1/8 Drill bit (1 pc)					

## Recommended Tools

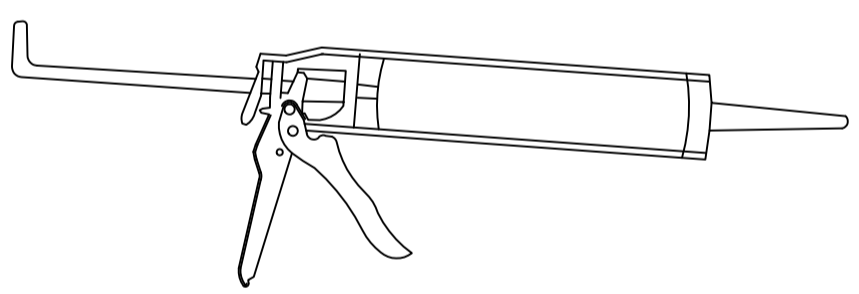
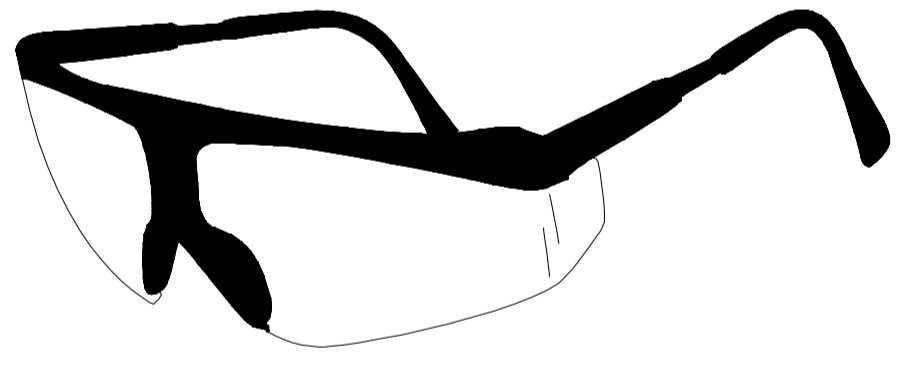
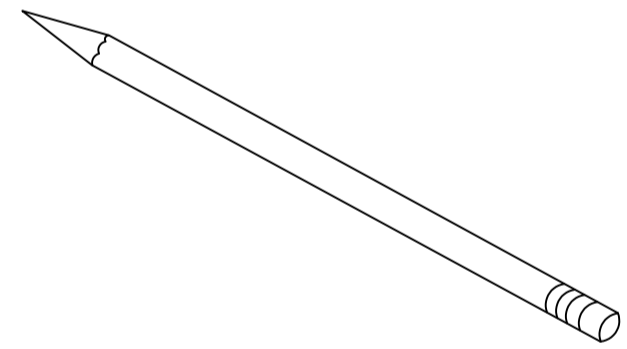
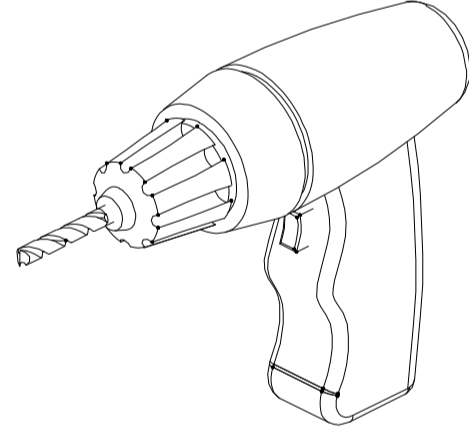
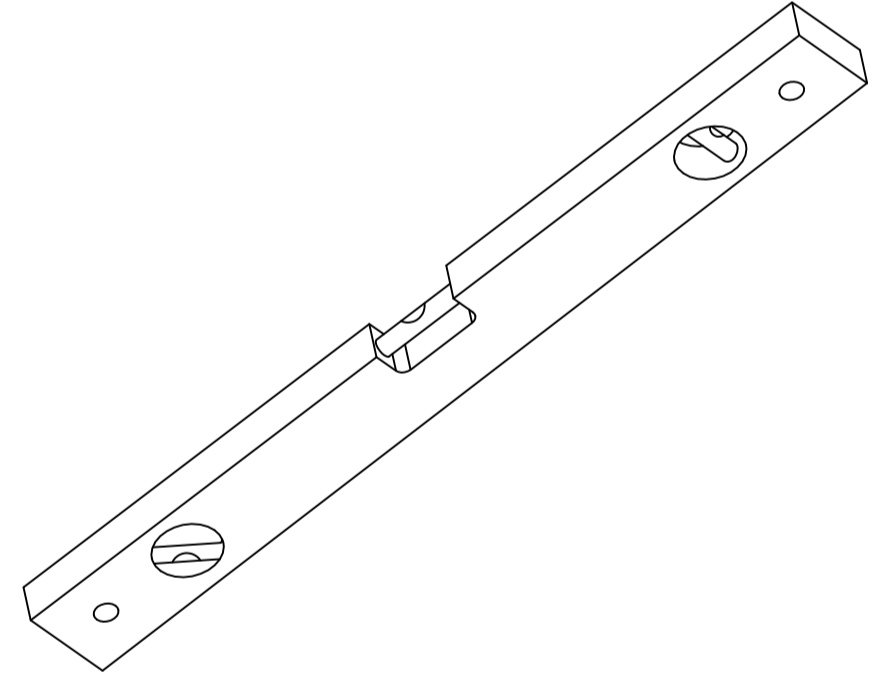
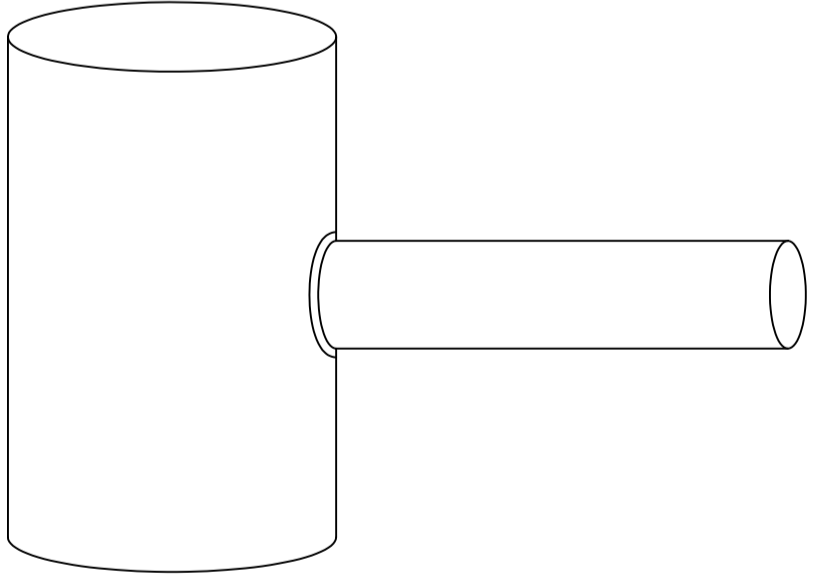
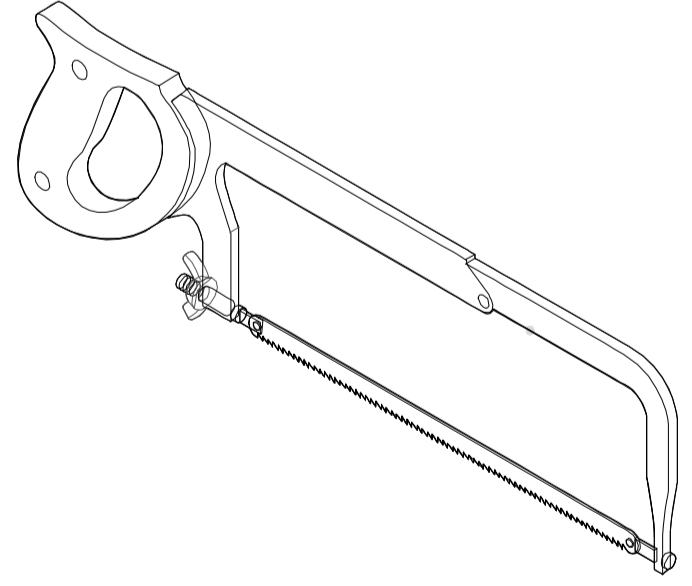
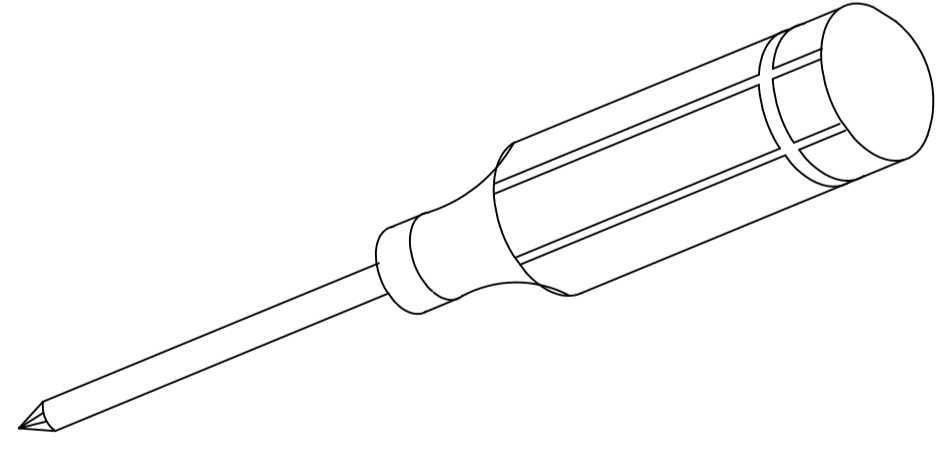
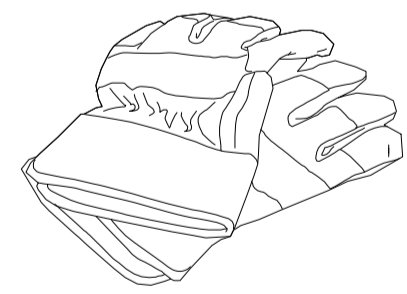
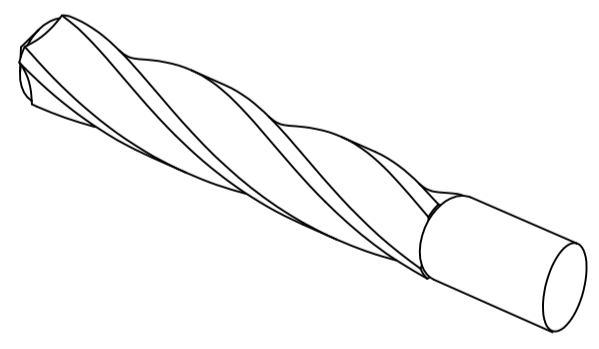
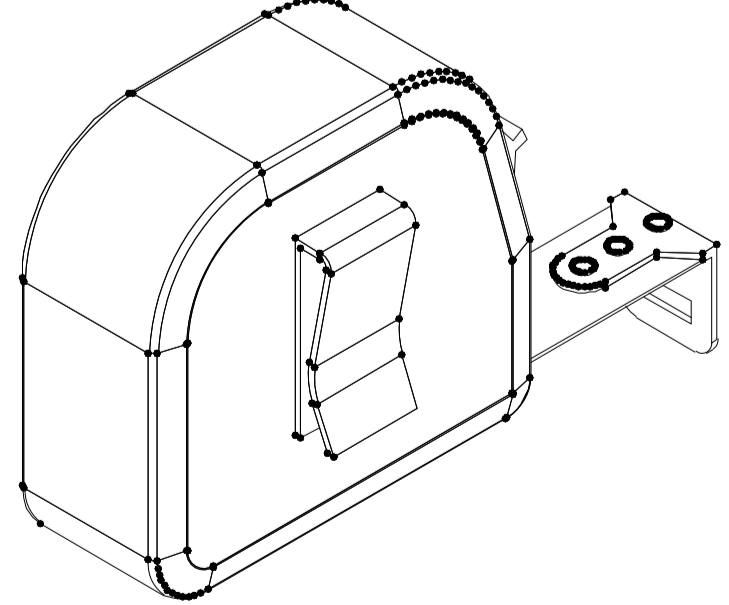
				
Silicone	Safety Glass	Pencil	Drill	Level
				
Rubber Hammer	Hacksaw	Screw Driver	Safety Gloves	1/4" Drill Bit
				
Tape Measure				

\* Utilize Safety Glasses and Safety Gloves when constructing this shower door  
 \* We recommend that 2 people work together to complete this installation

# (Left-hinged door) swivel wall material and door-sealing wall material installation

## STEP 1

1. Fix the swivel wall material (1) on the side wall.

L1=Distance from top to edge

L2=Distance from bottom to edge

Note: L1 = L2 during installation

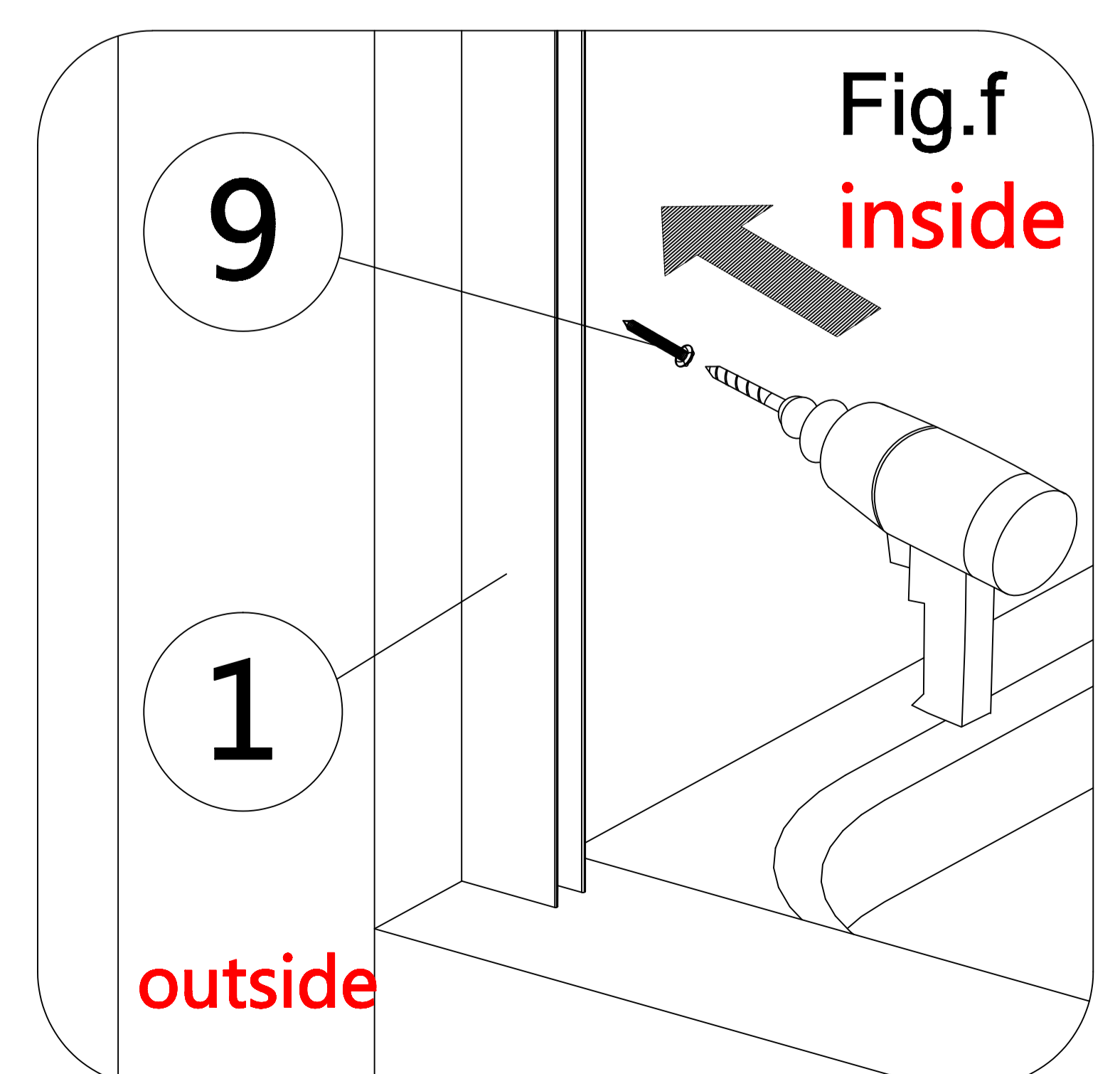
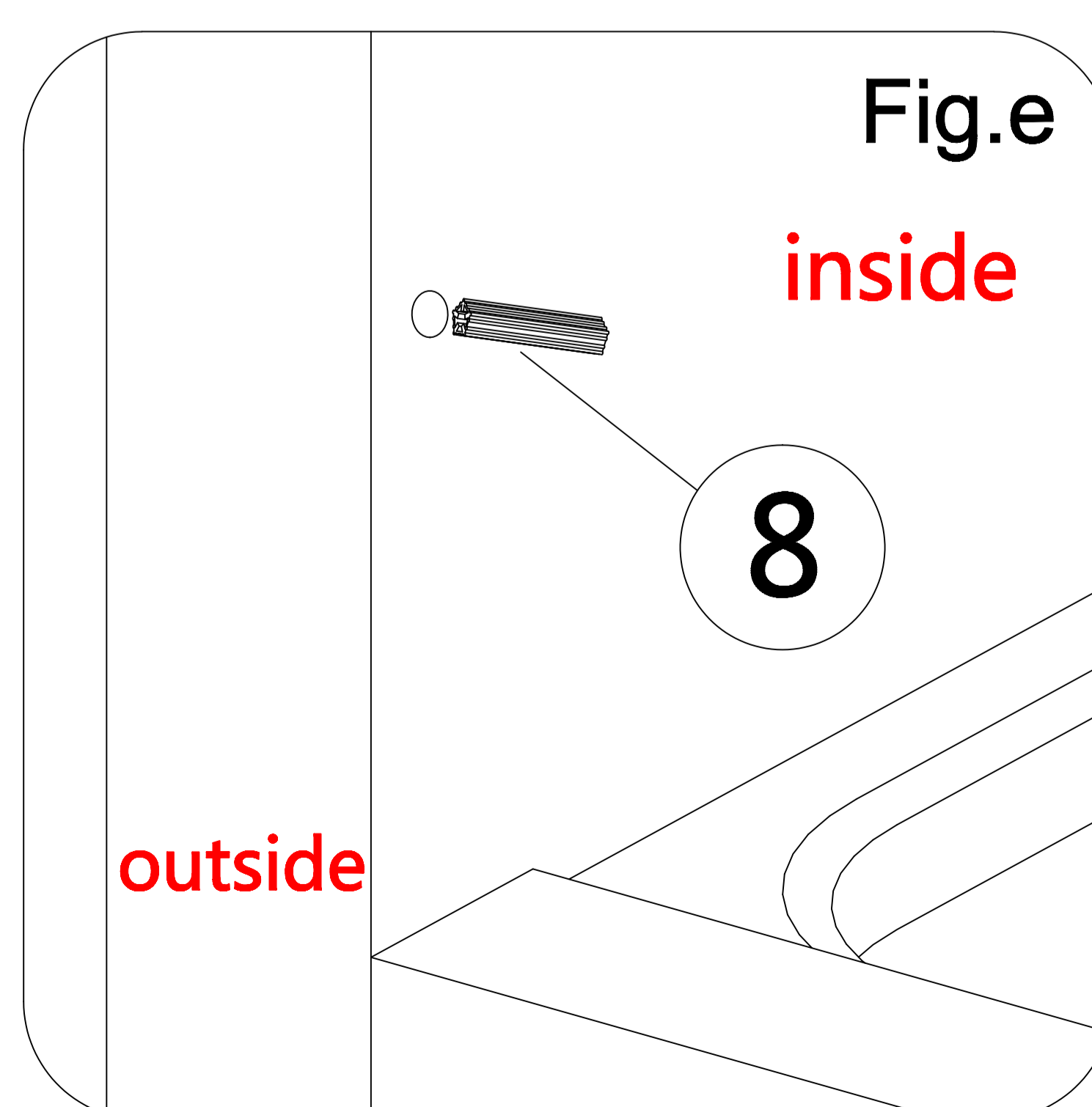
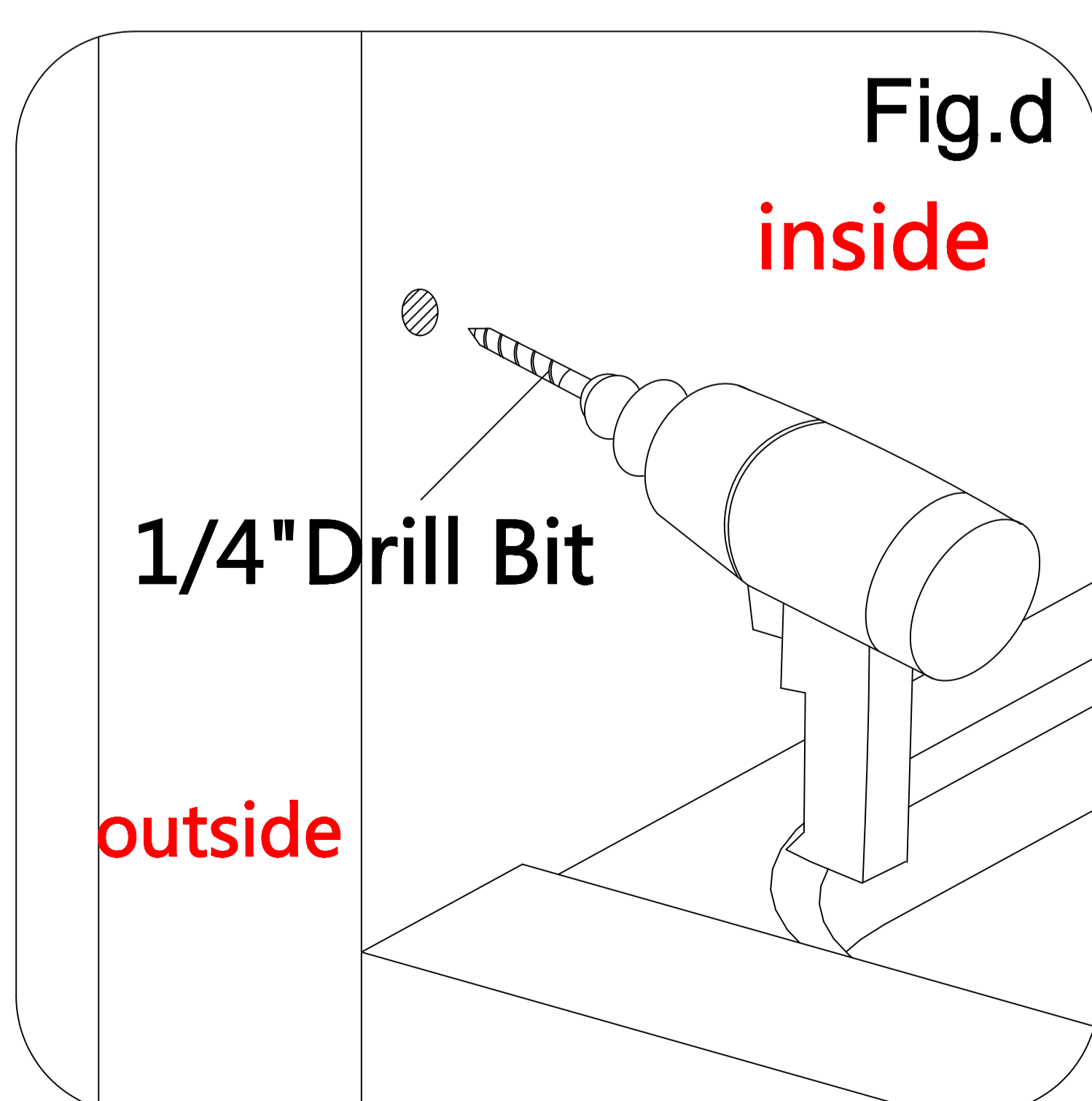
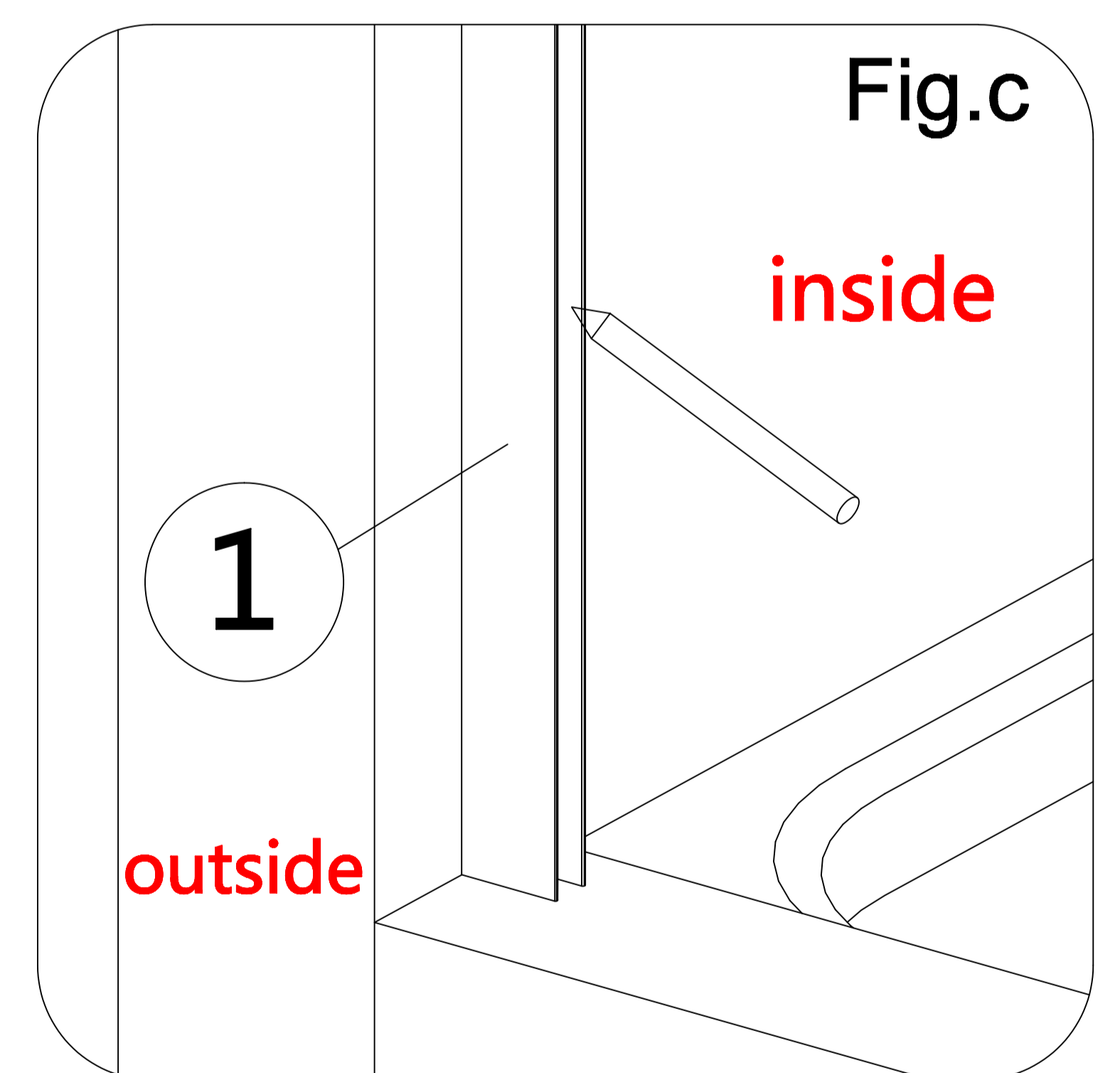
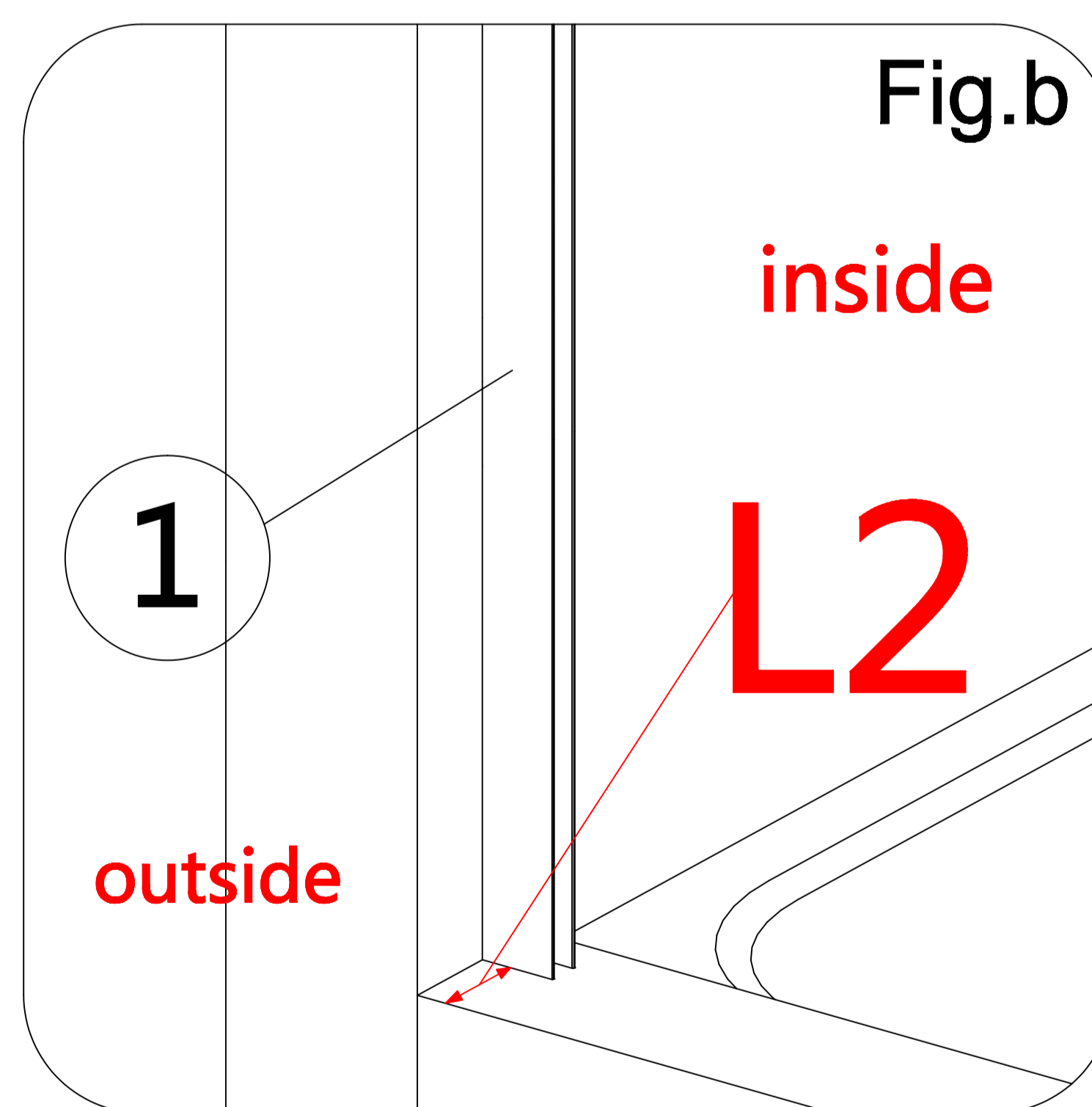
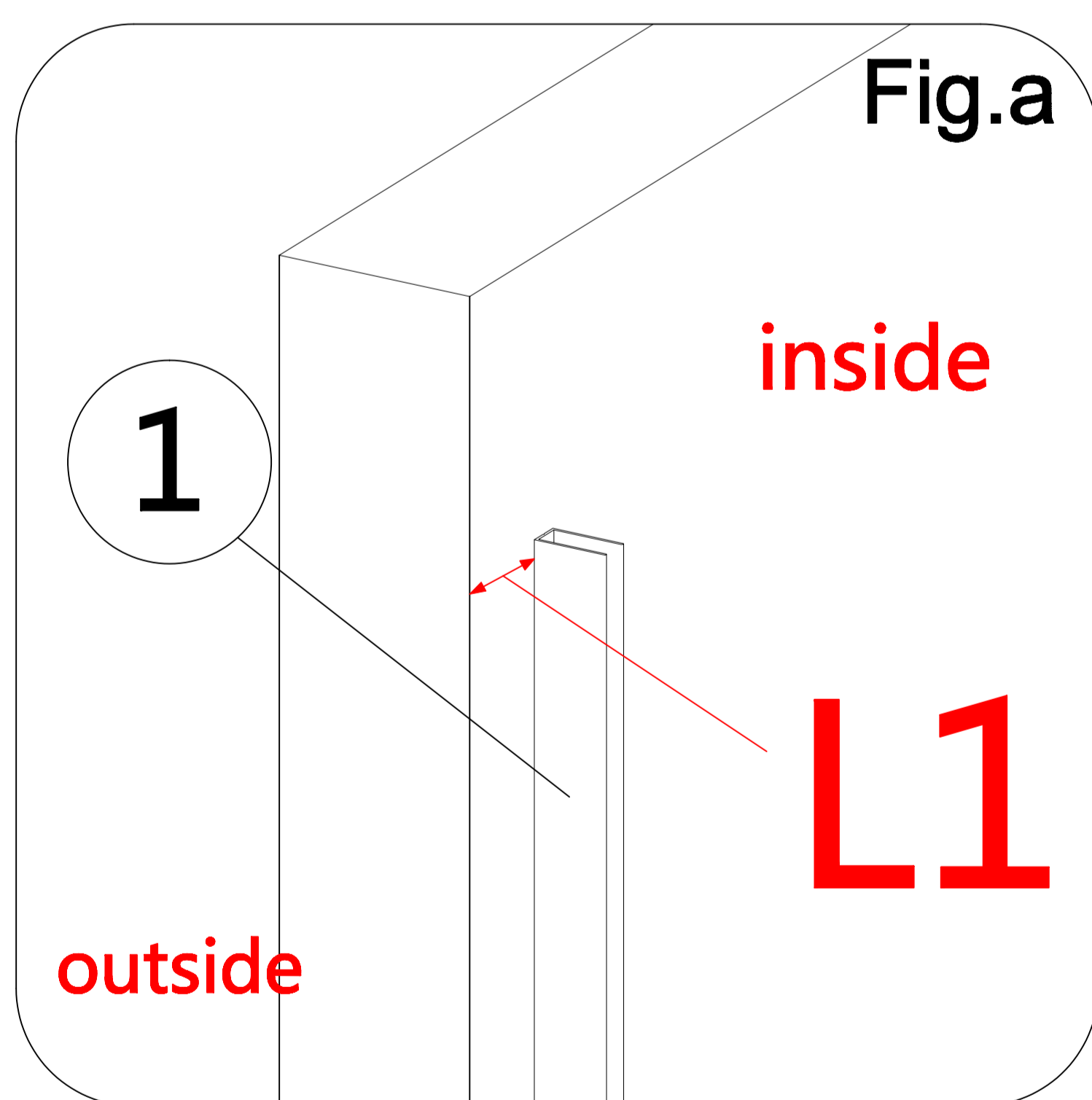
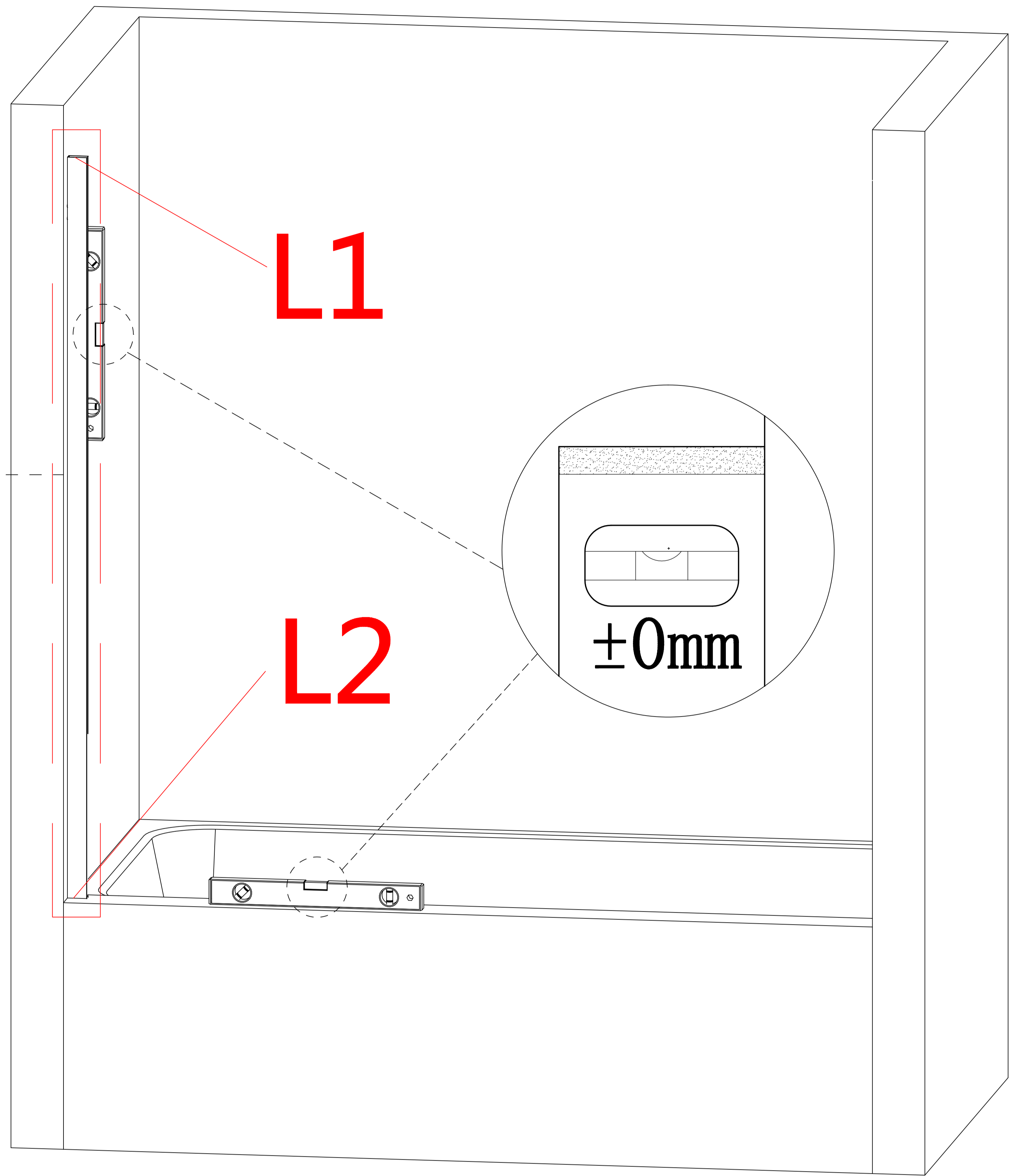
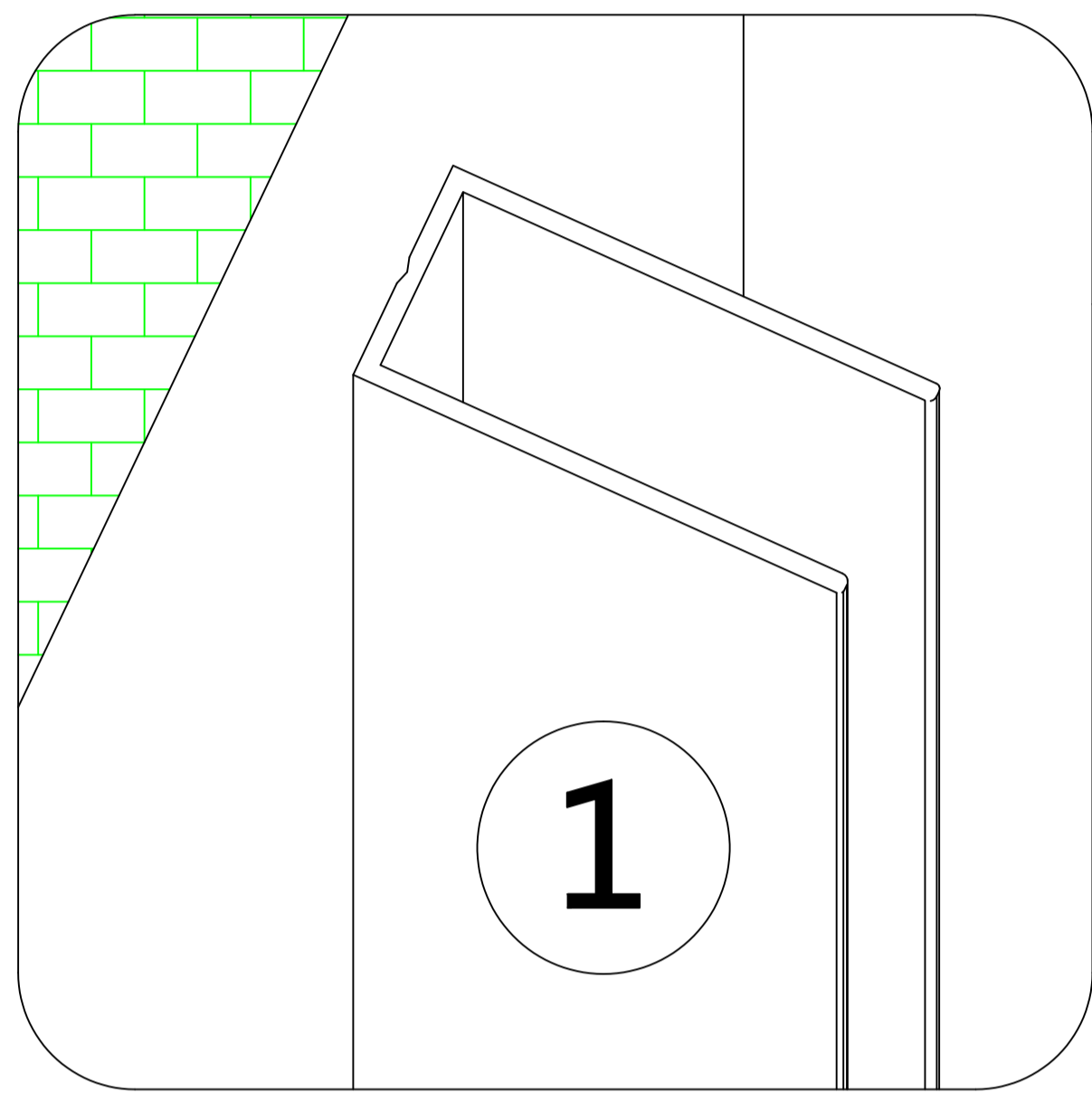

# (Right-hinged door) swivel wall material and door-sealing wall material installation

## STEP 1.1

1. Fix the swivel wall material (1) and door seal wall material (7) on the two side walls.

L1=Distance from the left edge.

L2=Distance from the right edge.

Note: L1 = L2 during installation

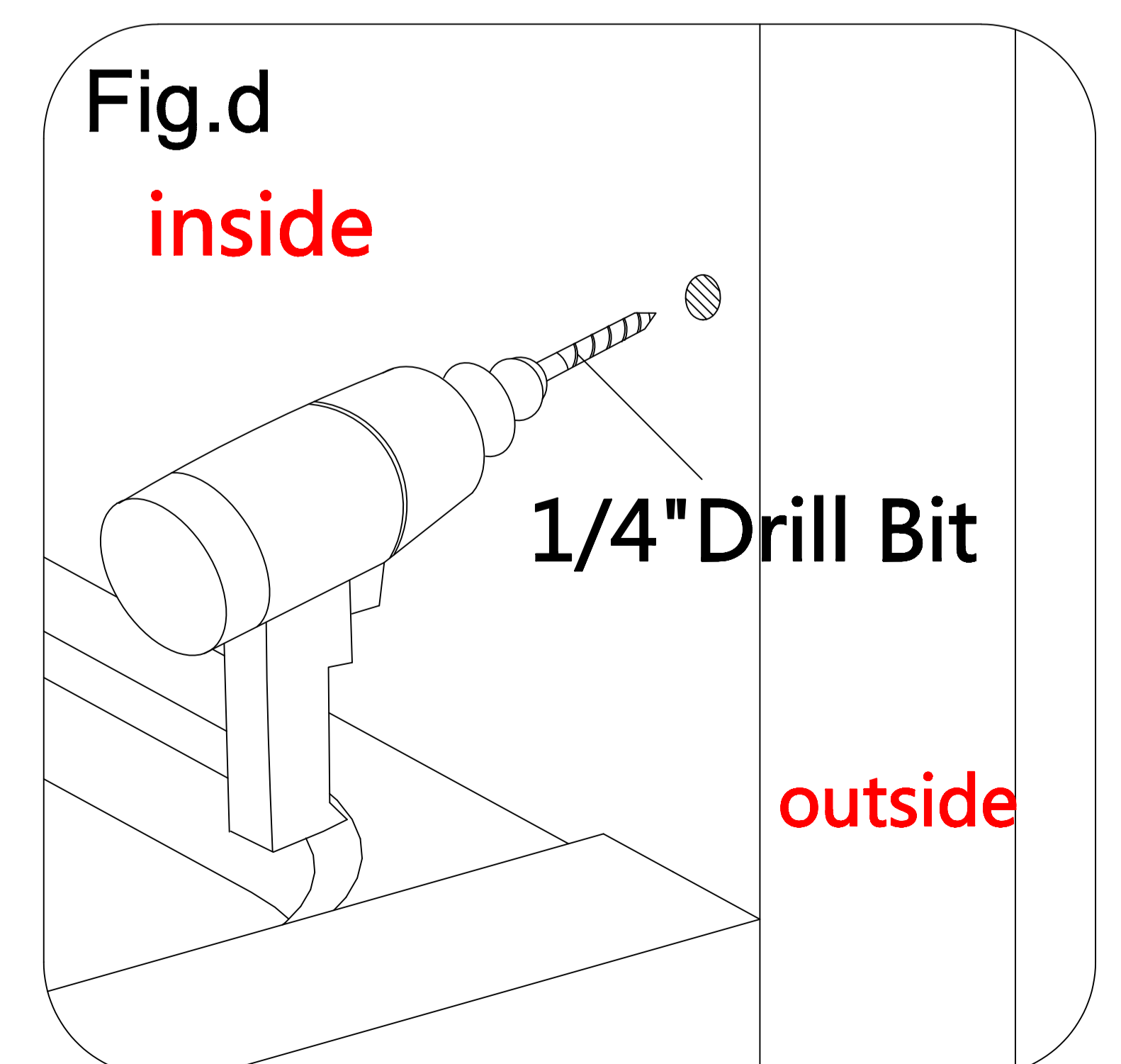
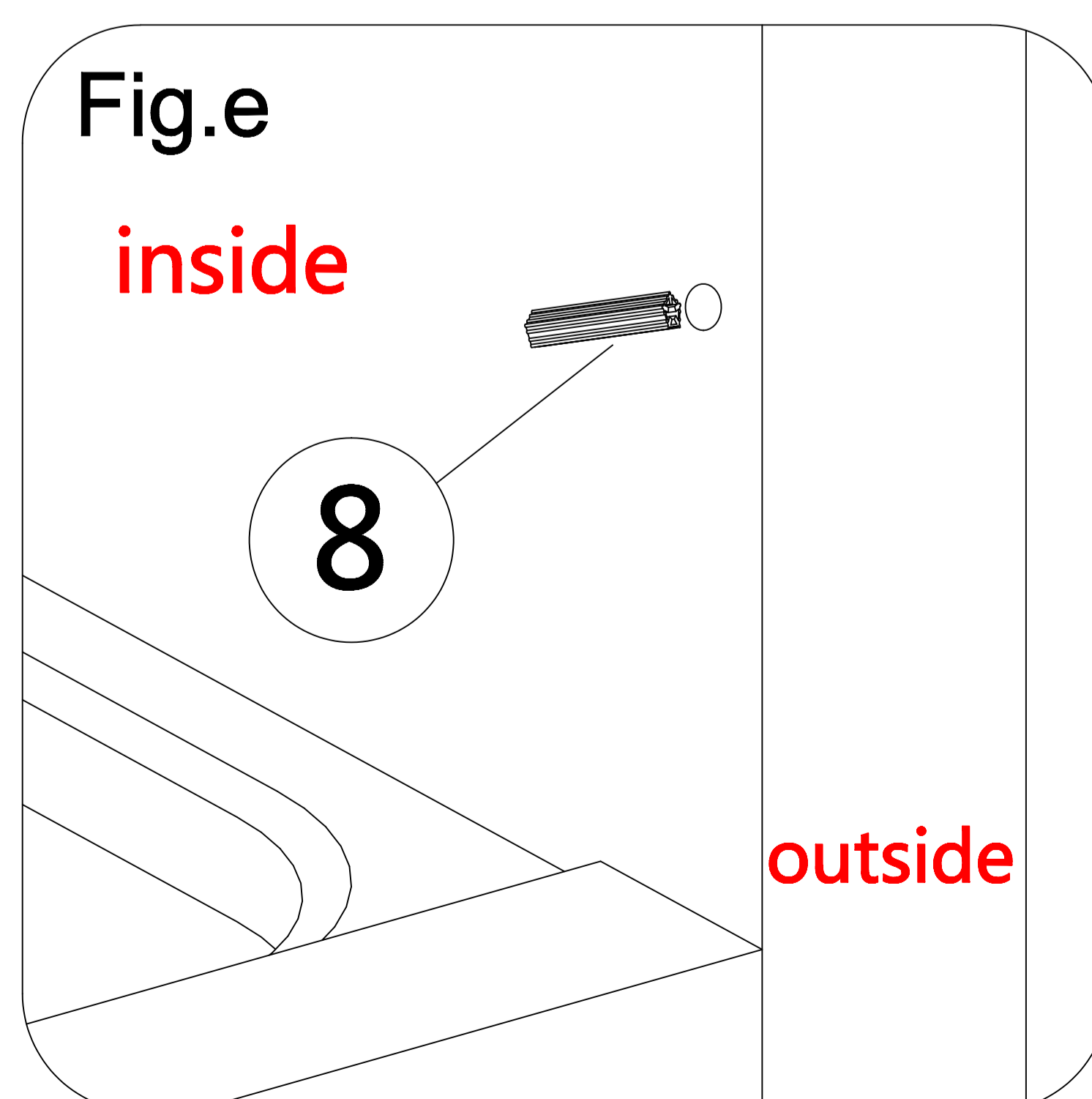
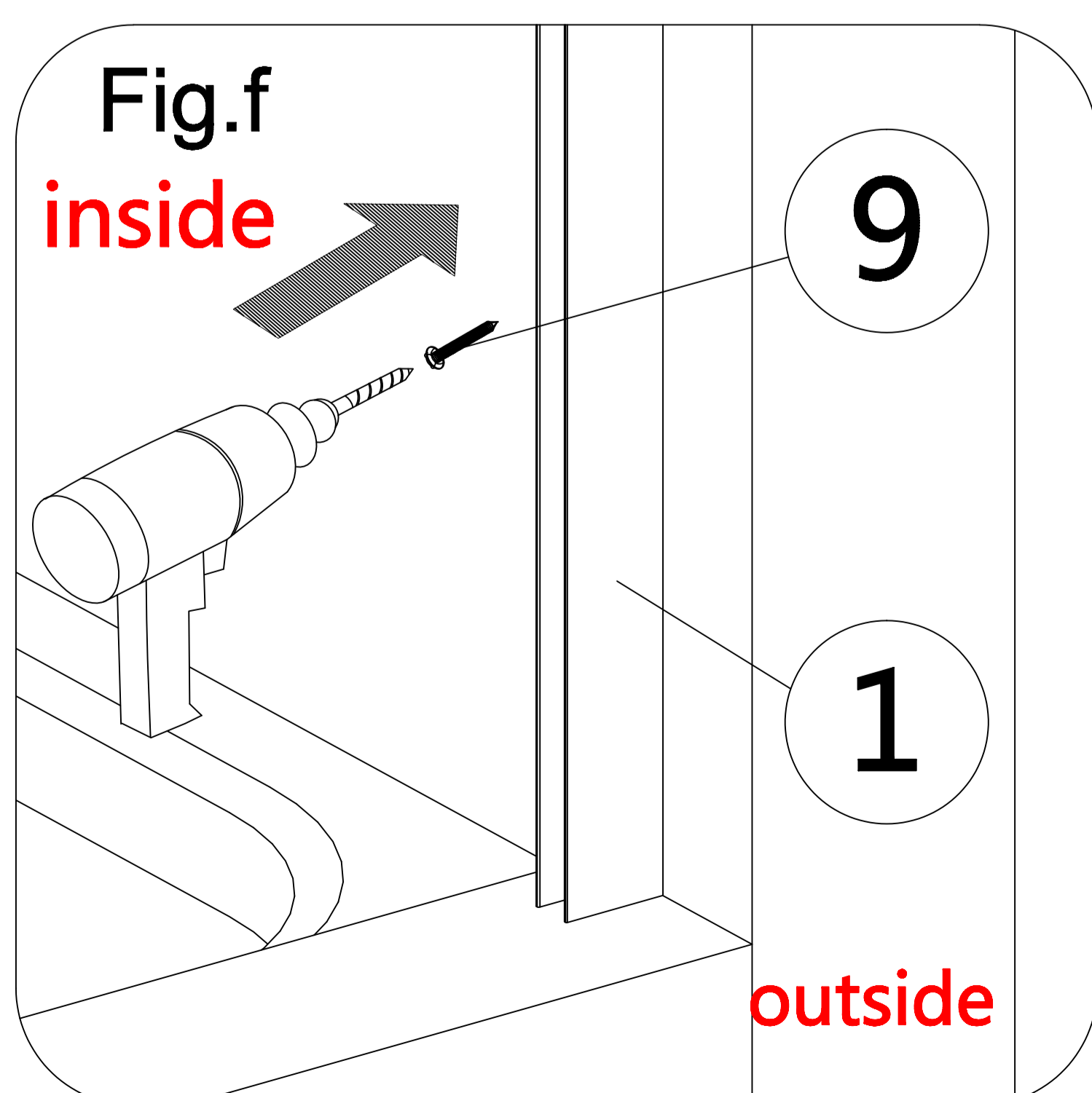
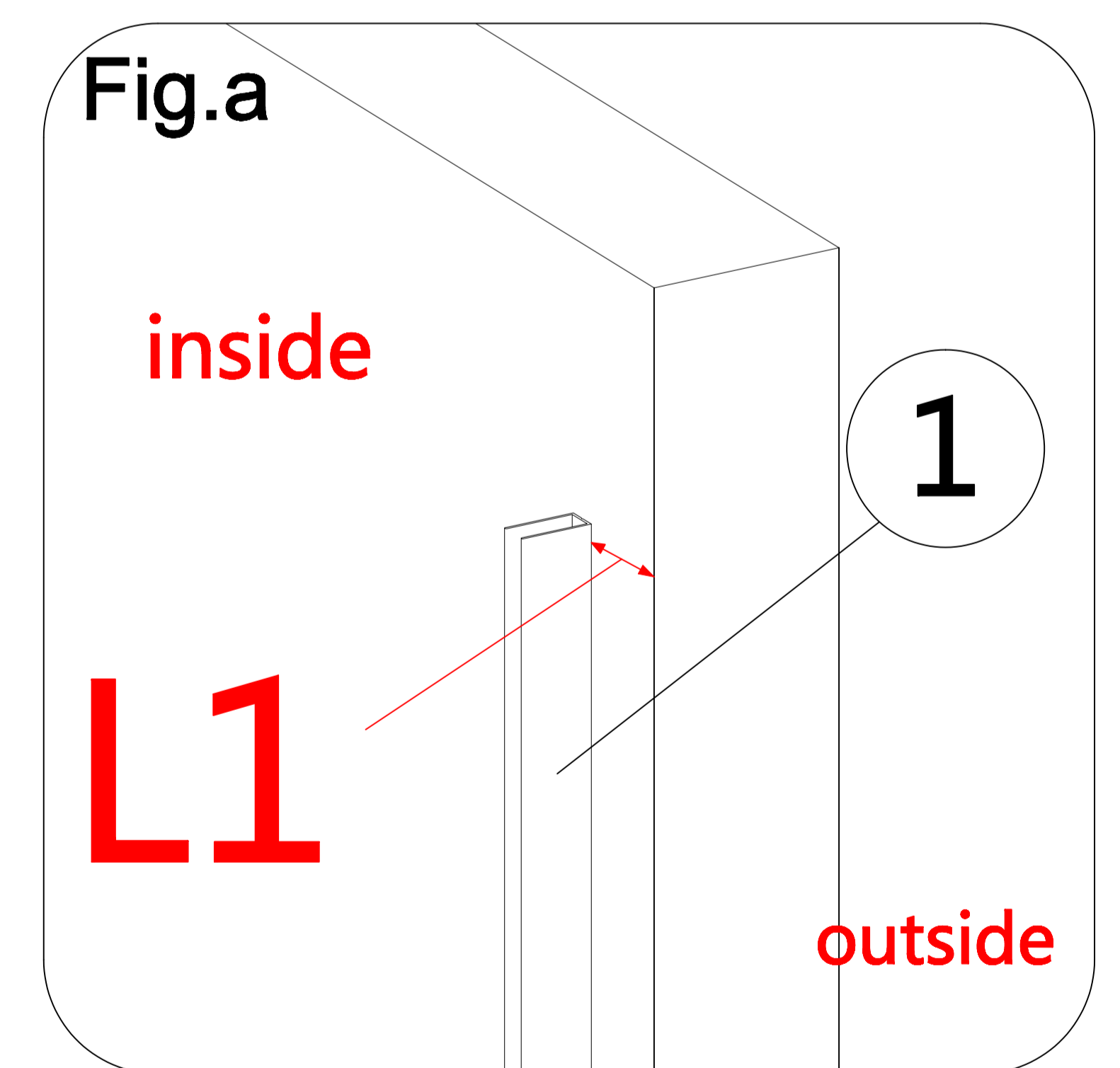
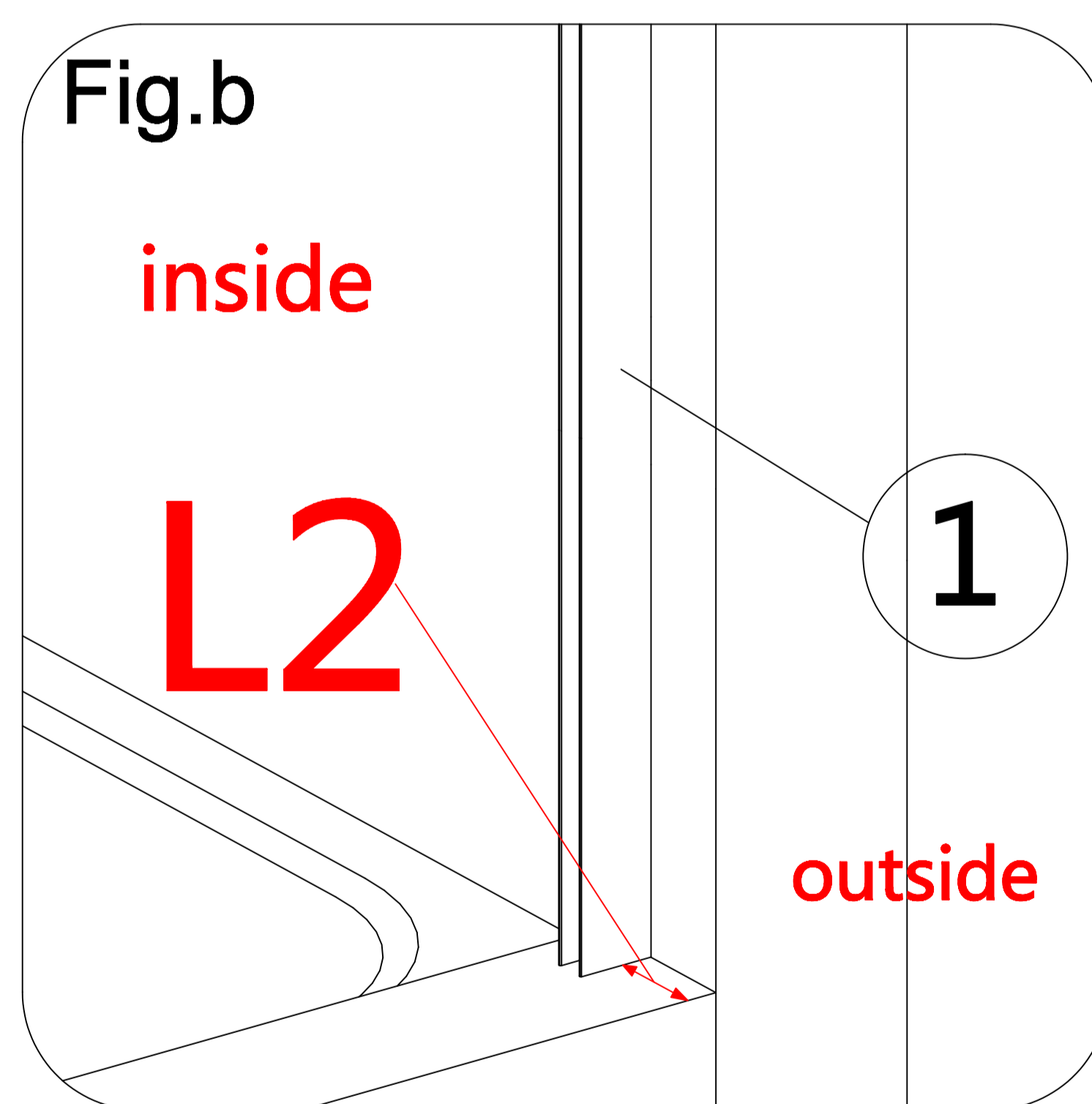
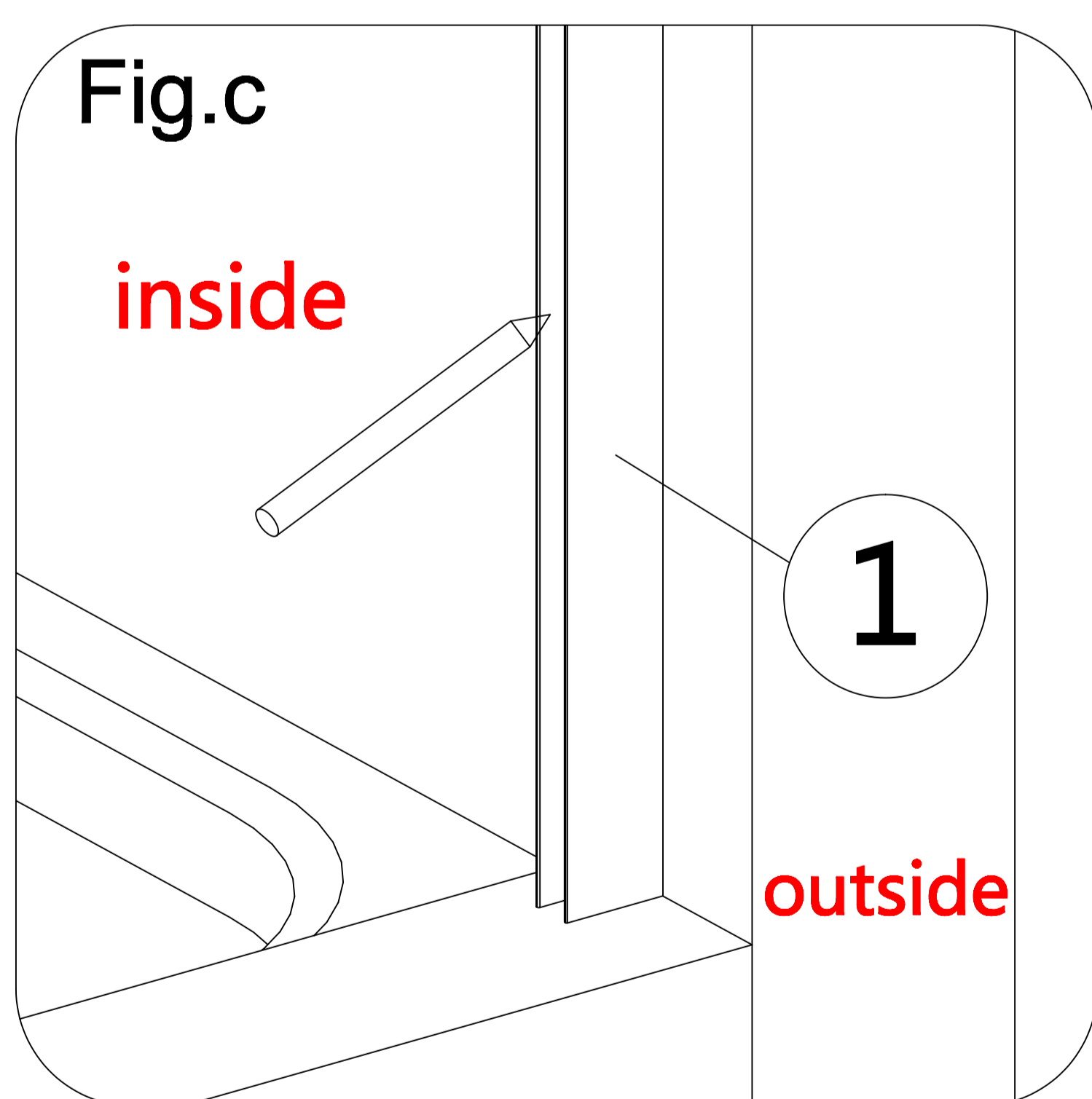
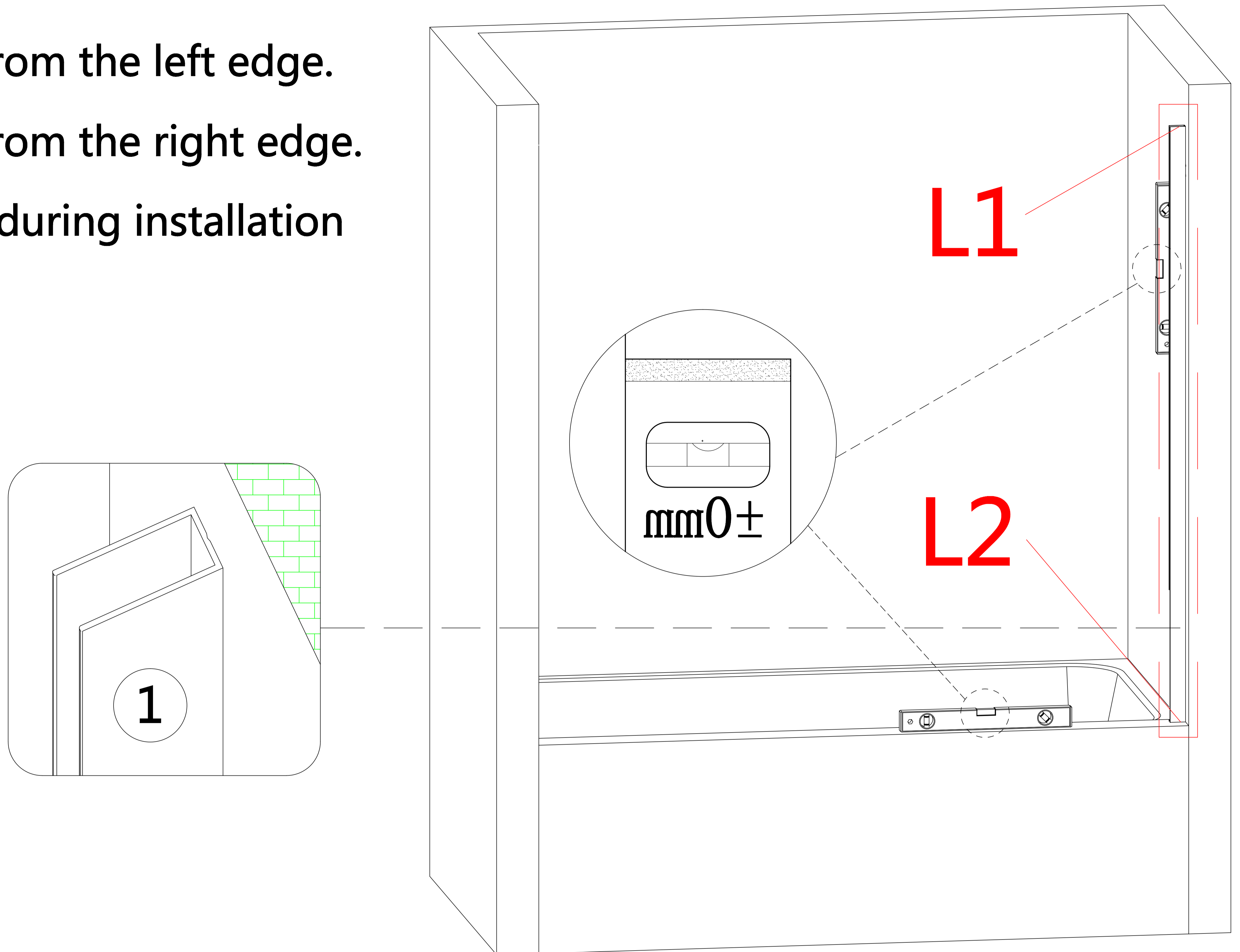

# (Left-hinged door) Adjustment of fixed shaft material installation

## STEP 2

1. As shown in Fig.a and Fig.b, install the bottom lifting shaft (7) to the bottom of the fixed shaft material with ST4.0X20 screws(12).
2. As shown in Fig.c and Fig.d, embed the fixed shaft material (2) into the Swivel wall material (1) until the two profiles are flush, and then mark the position of the smallest size hole with a marker
3. As shown in Fig.e and Fig.f, pull the fixed shaft material (2) out by Y inches ( $Y \leq 1$  inch) according to the actual situation. If no adjustment needed, the hole position marked in Fig. c can be directly punched.
4. As shown in Fig. g, after determining the size, mark the hole position with Pencil.
5. Take out the fixed shaft material (2) and punch the position marked in Fig. g.
6. As shown in Fig. I and Fig. J , Put the punched profile back into the Swivel wall material (1) Tighten the ST4.0X8 screws (11) through the fixed cover base (10).

**Note: The maximum adjustment range of the fixed shaft material is 1 inch.**

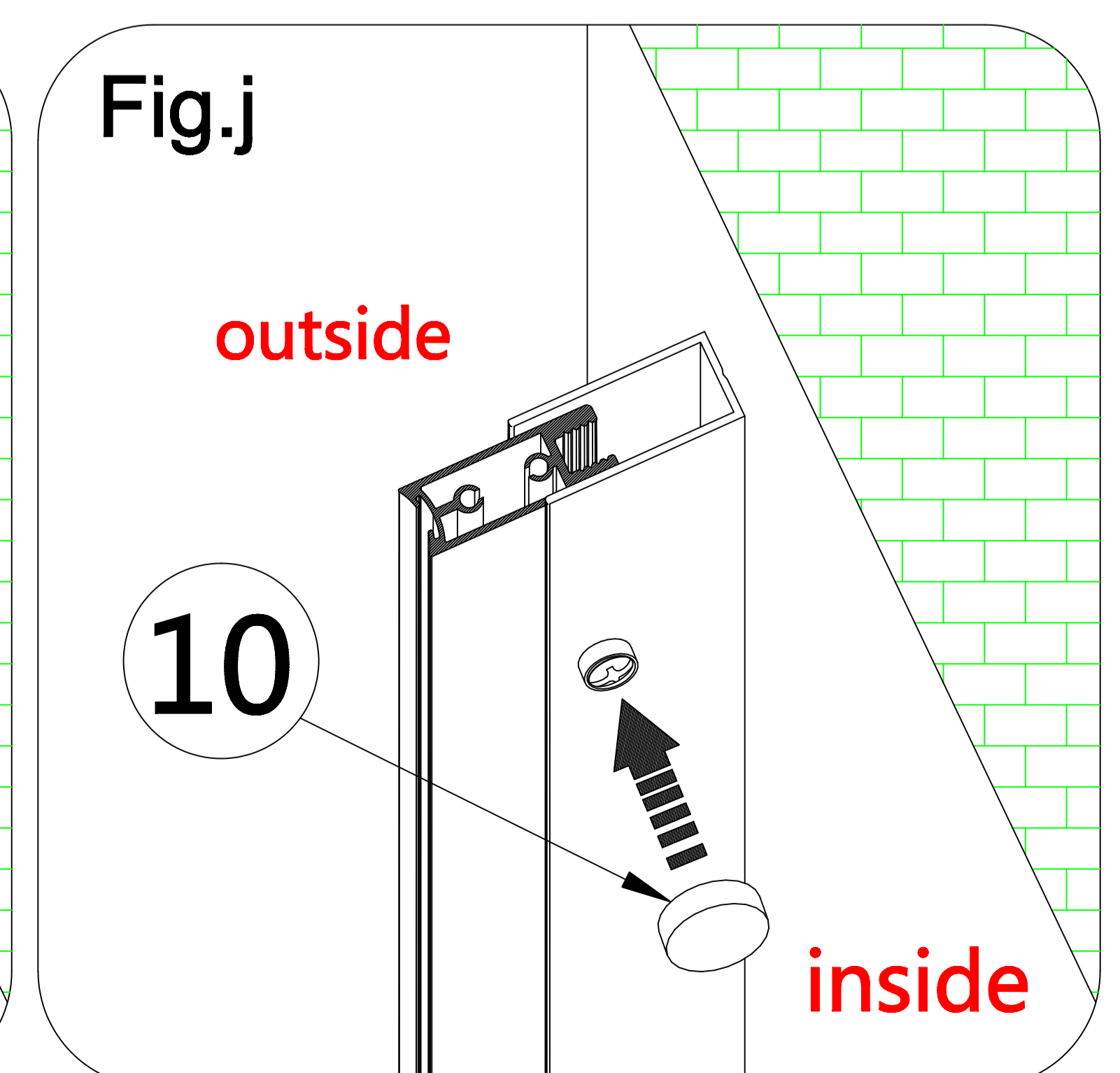
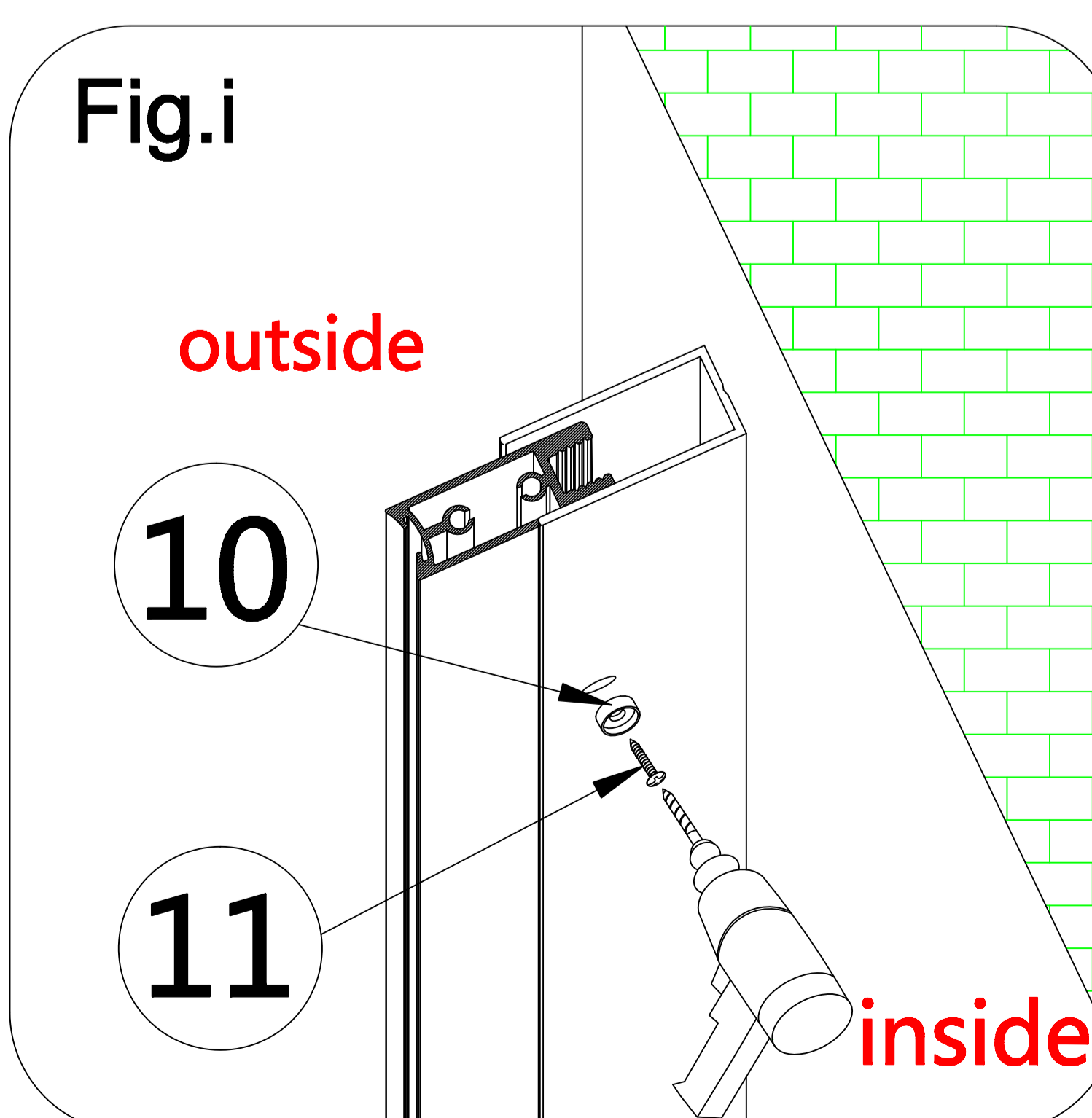
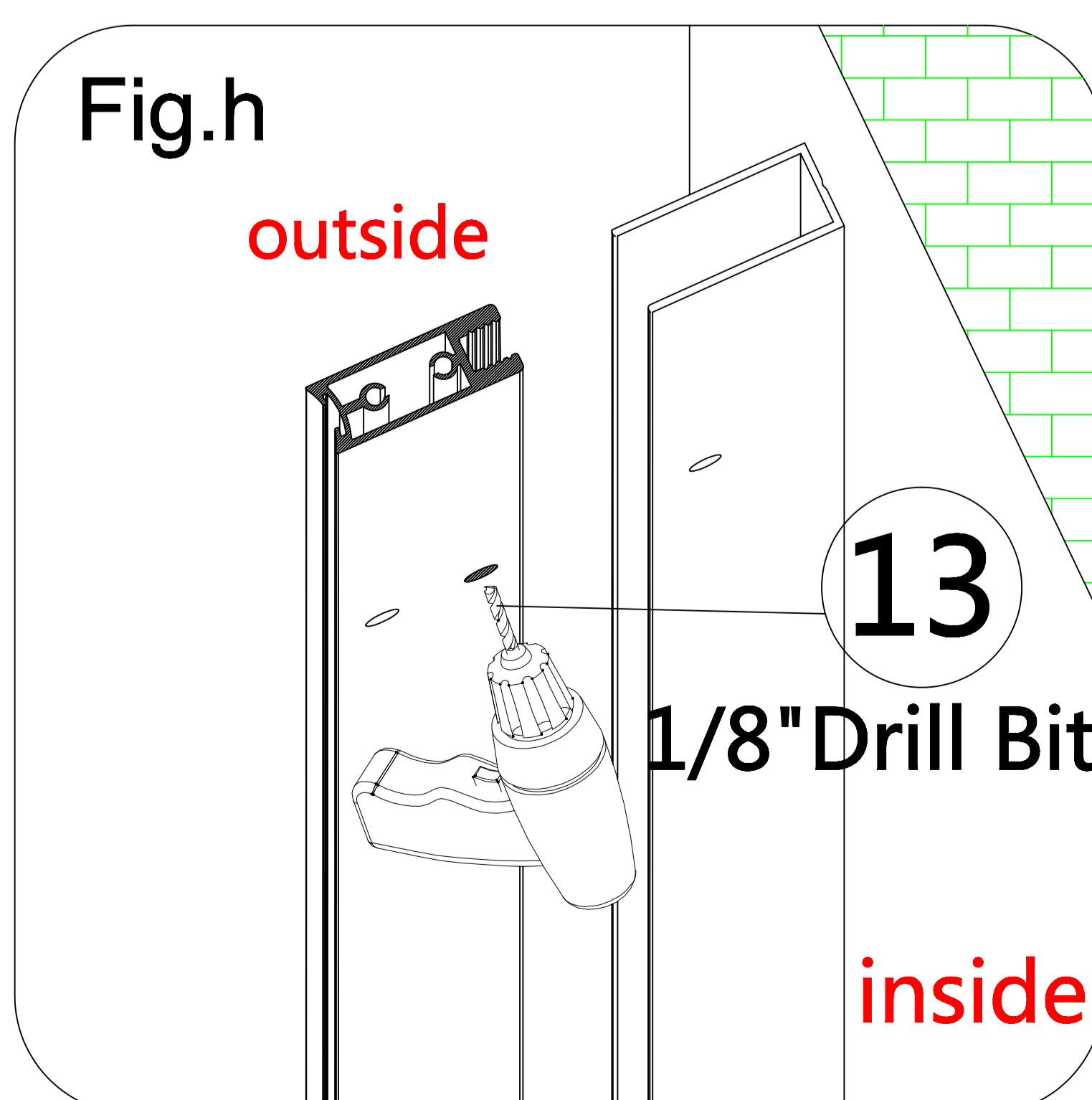
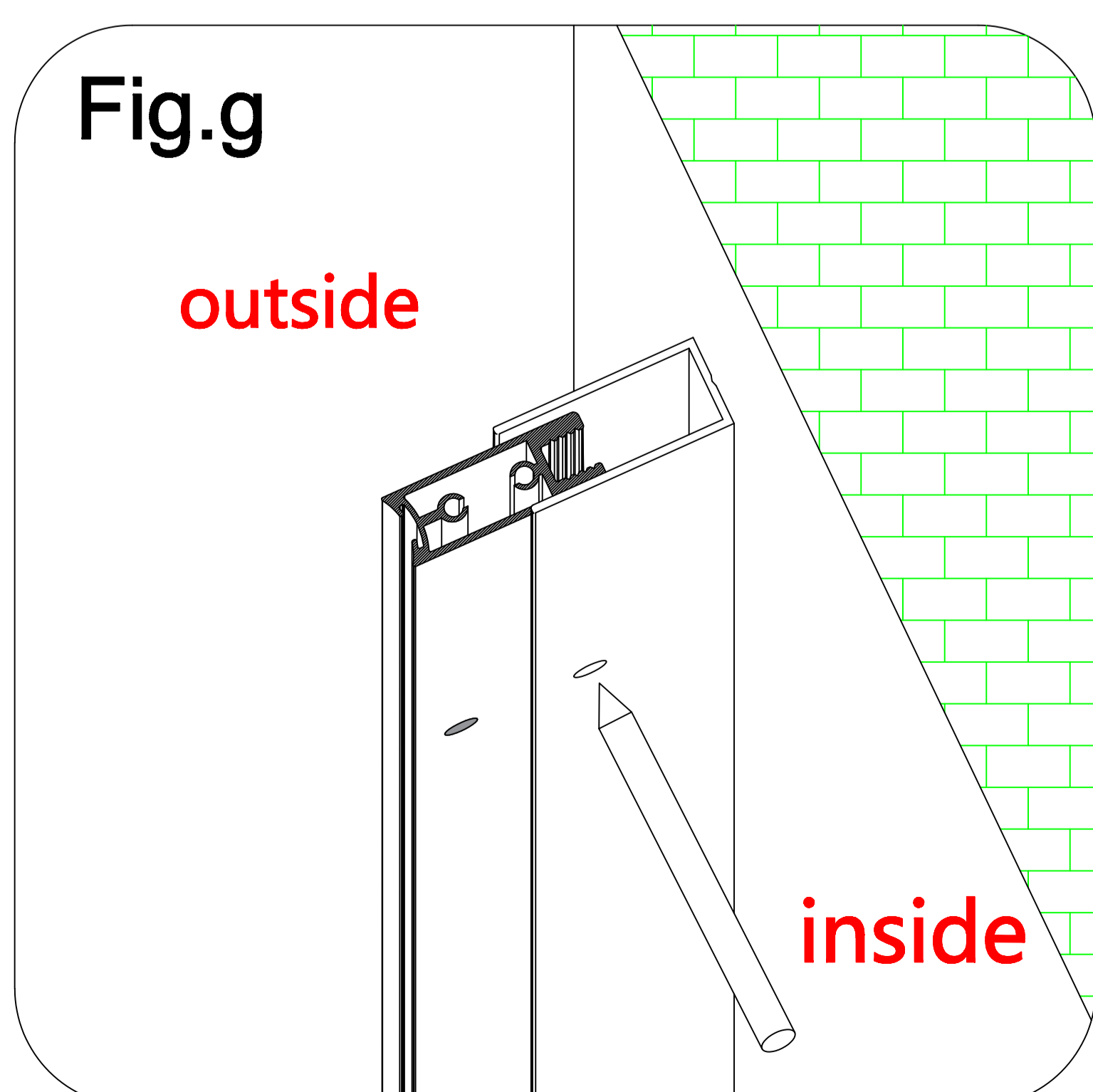
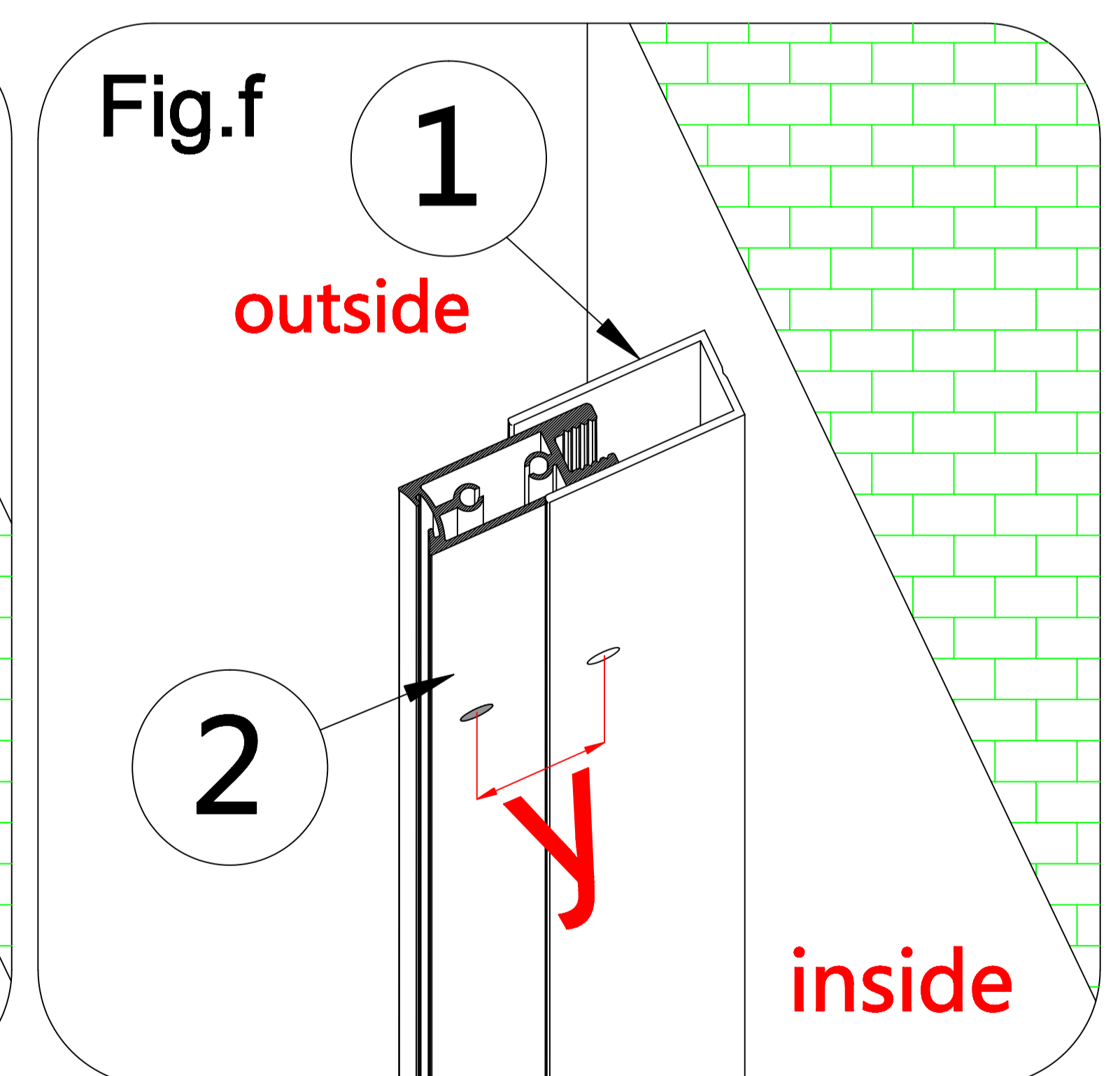
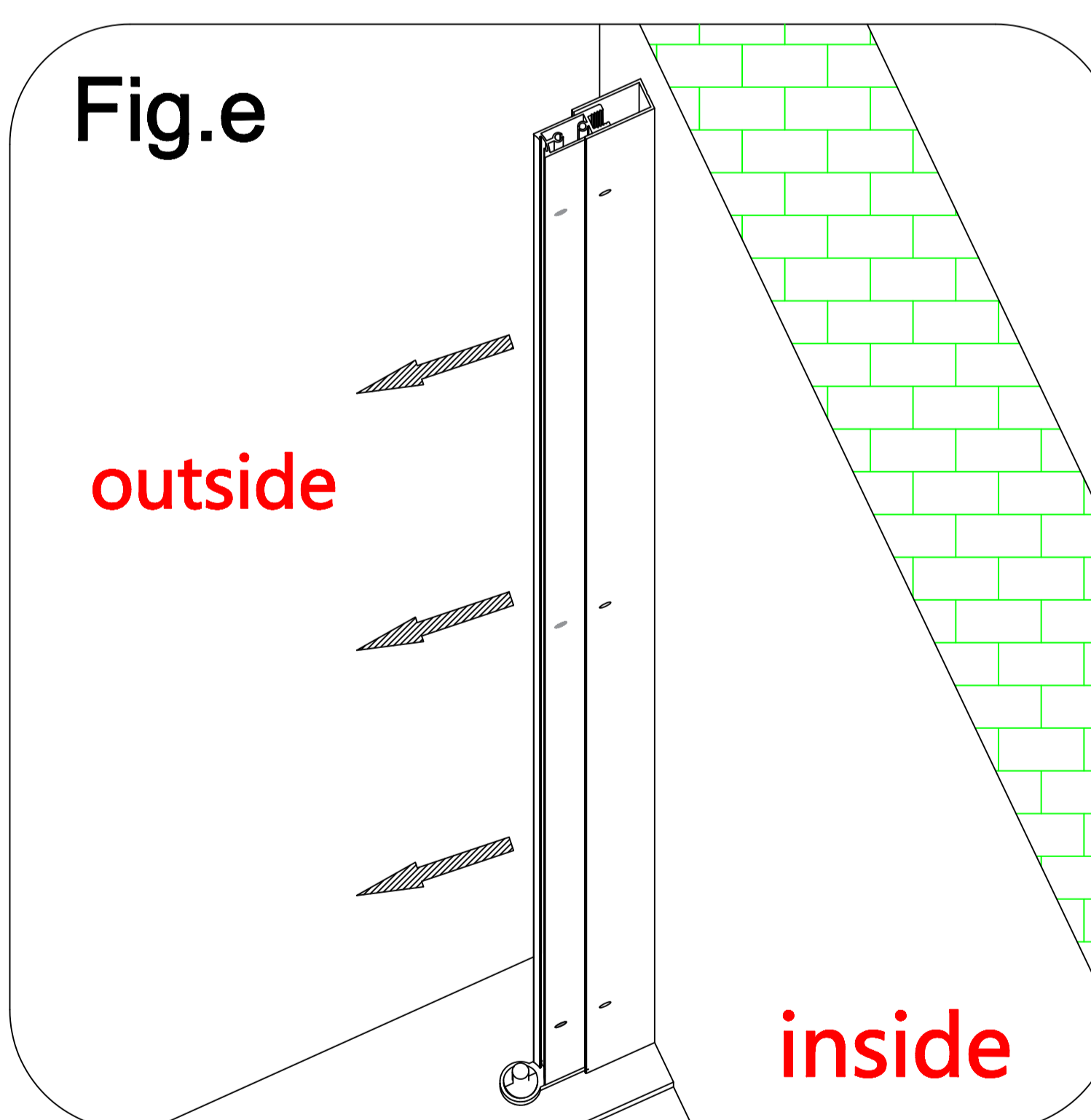
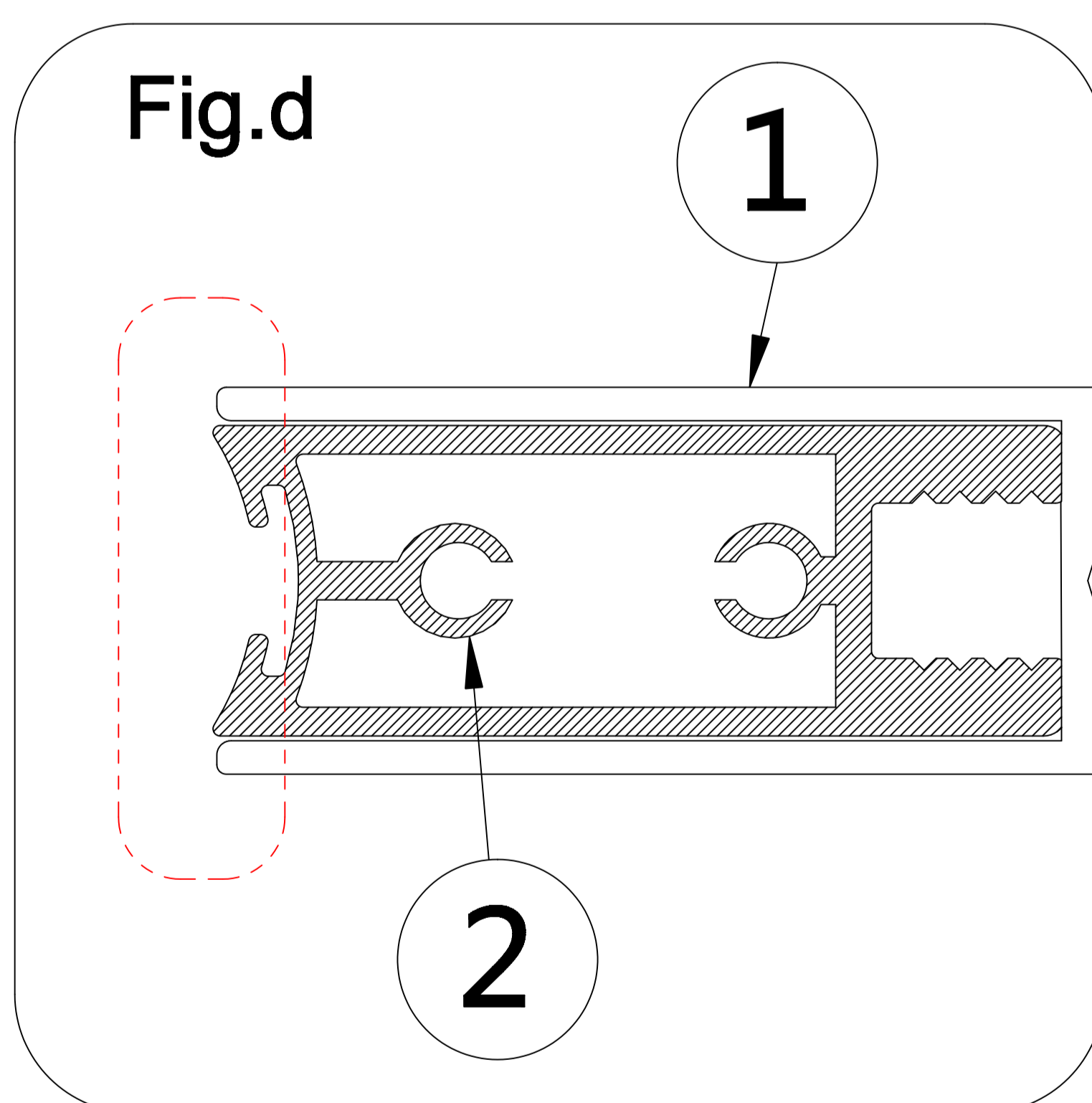
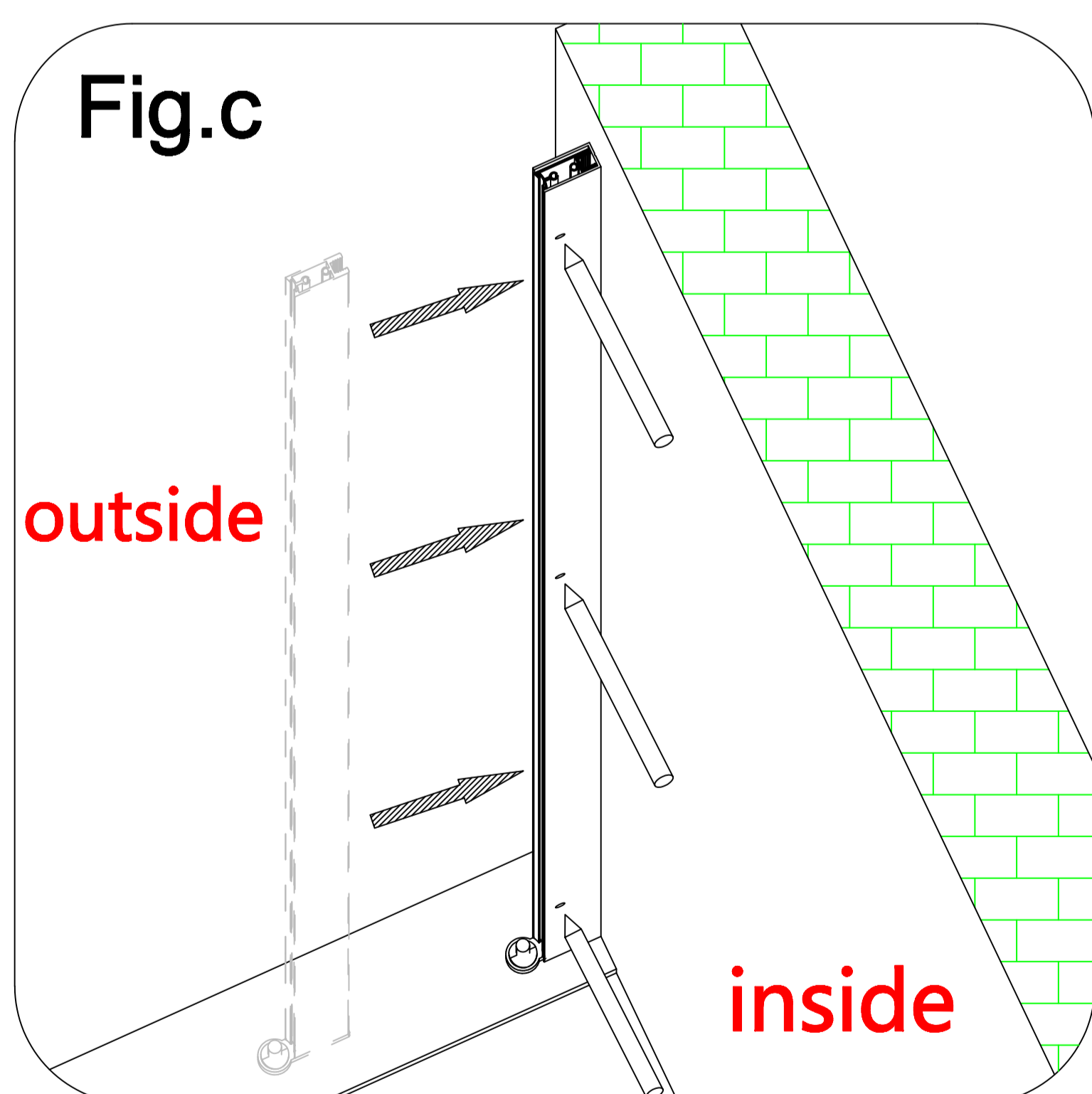
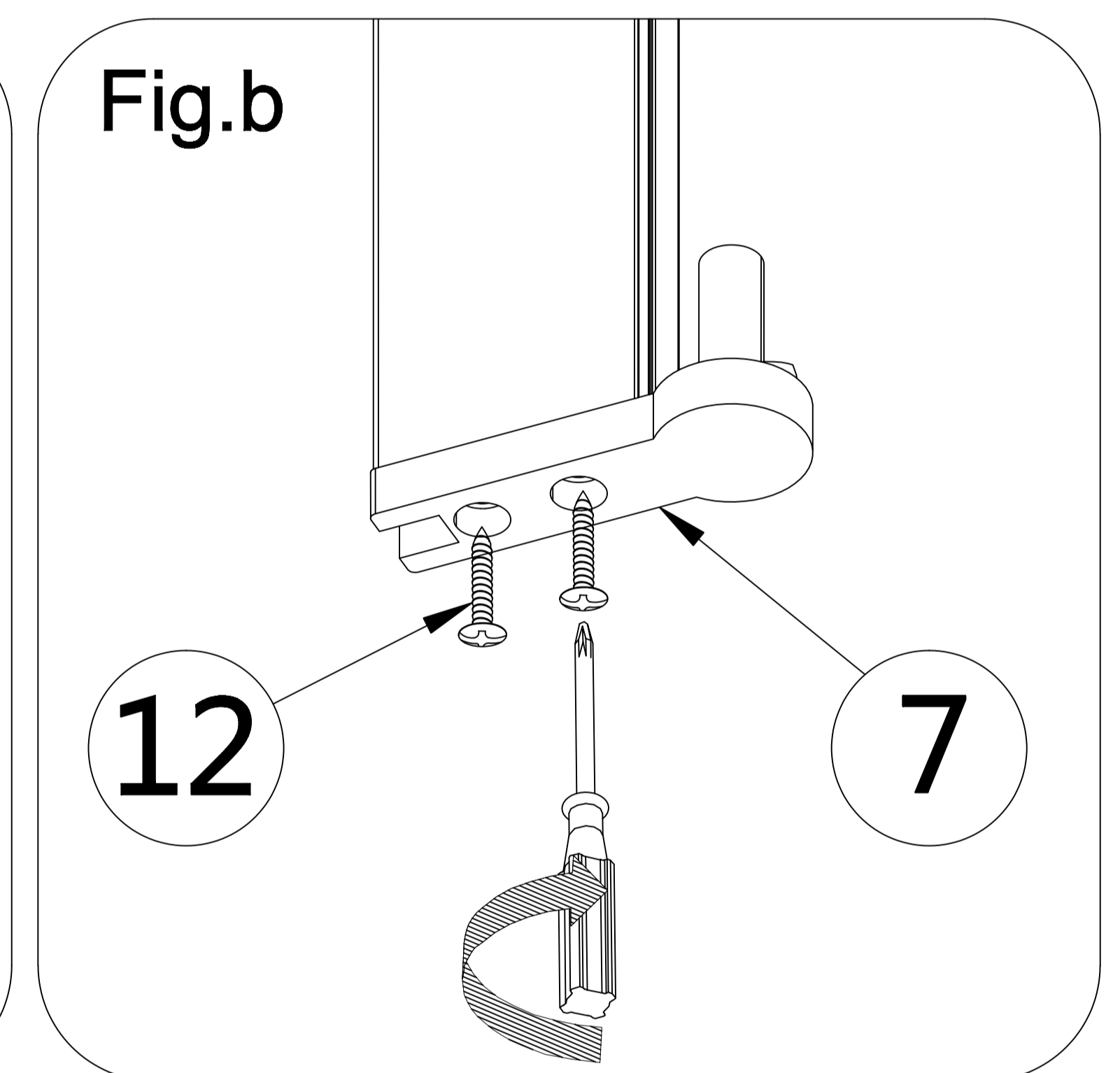
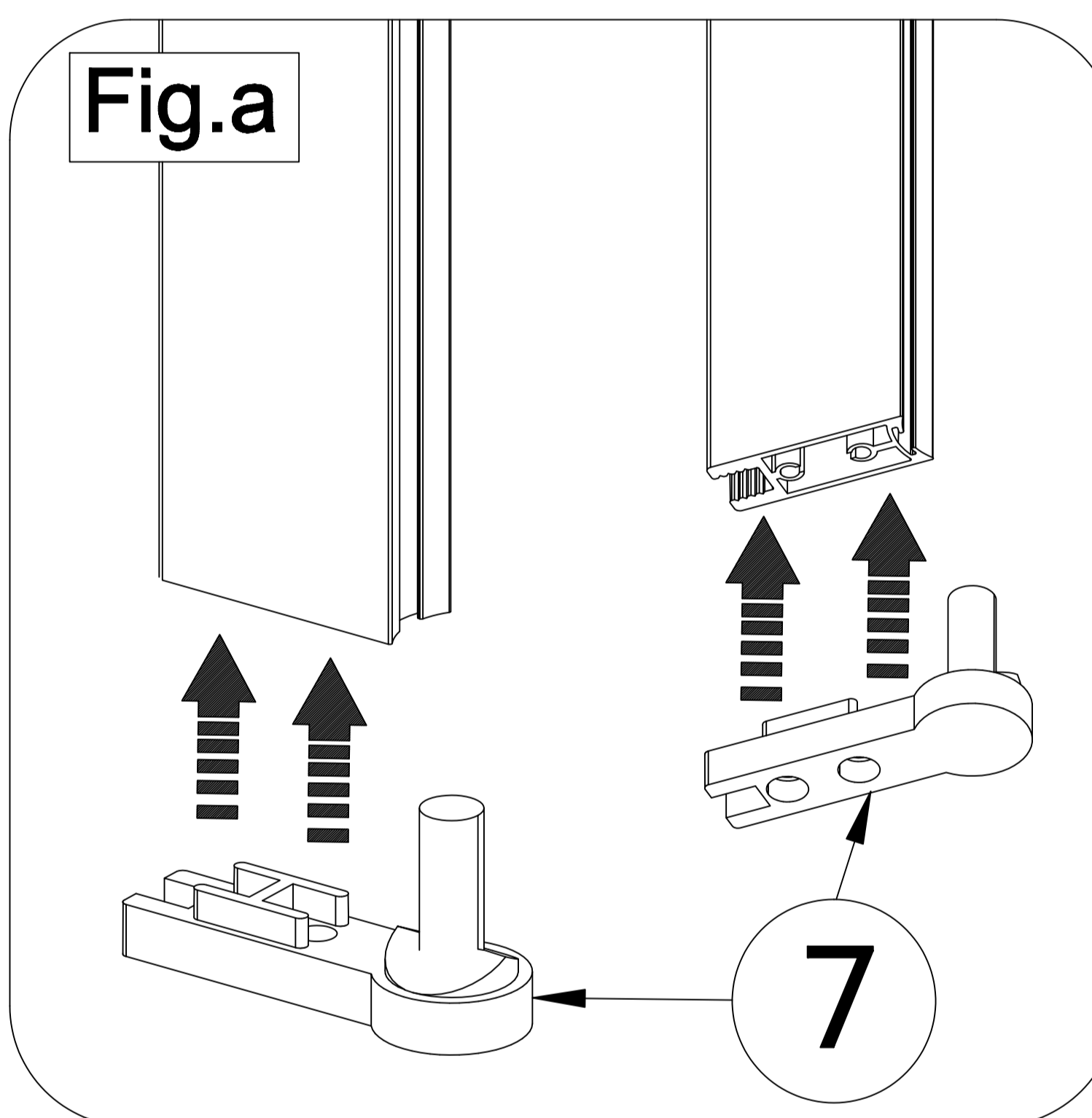
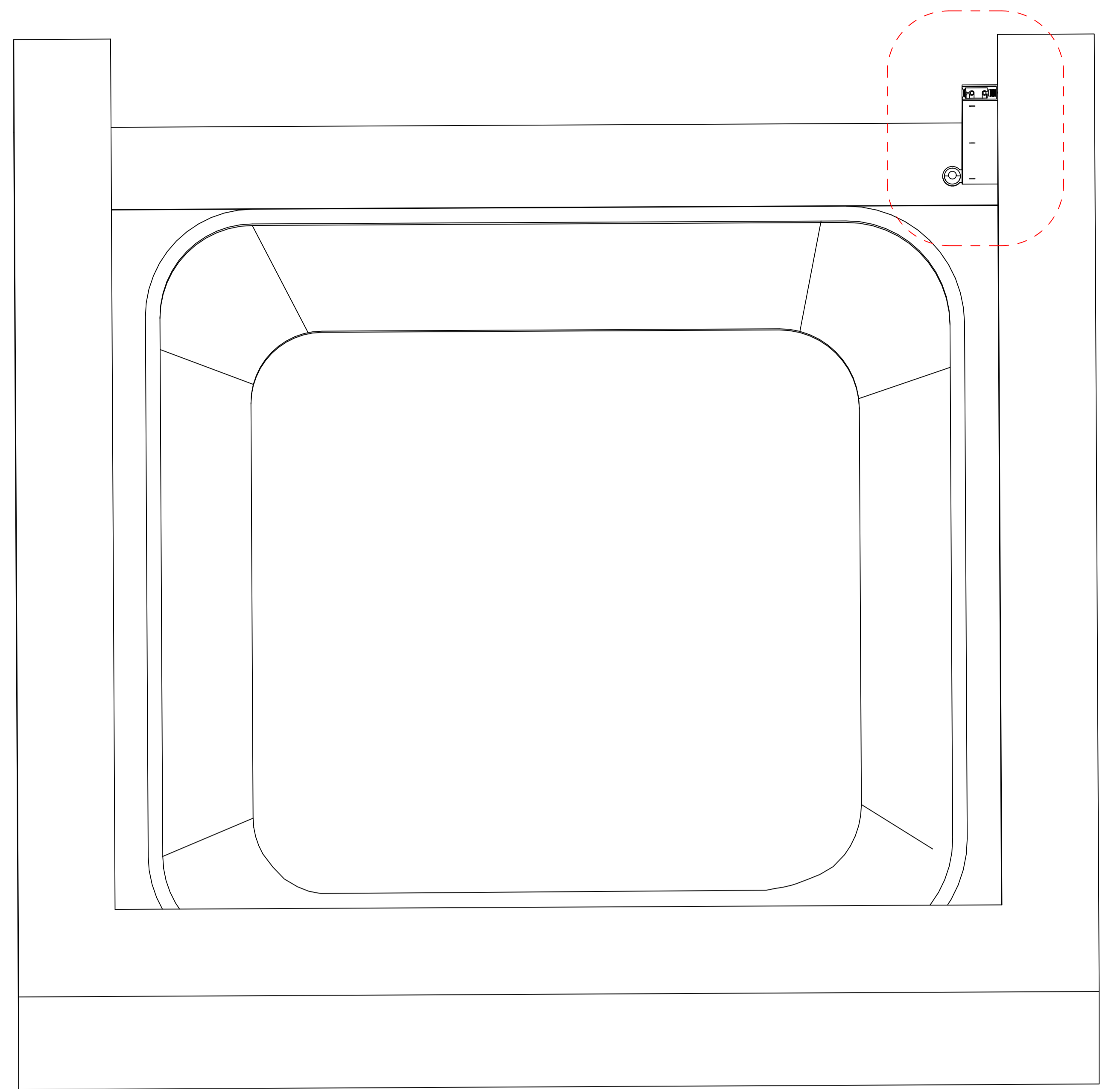

# (Right-hinged door) Fixed shaft material installation adjustment

## STEP 2.1

1. As shown in Fig.a and Fig.b, install the bottom lifting shaft (7) to the bottom of the fixed shaft material with ST4.0X20 screws(12).
2. As shown in Fig.c and Fig.d, embed the fixed shaft material (2) into the Swivel wall material (1) until the two profiles are flush, and then mark the position of the smallest size hole with a marker
3. As shown in Fig.e and Fig.f, pull the fixed shaft material (2) out by Y inches ( $Y \leq 1$  inch) according to the actual situation. If no adjustment needed, the hole position marked in Fig. c can be directly punched.
4. As shown in Fig. g, after determining the size, mark the hole position with Pencil.
5. Take out the fixed shaft material (2) and punch the position marked in Fig. g.
6. As shown in Fig. I and Fig. J , Put the punched profile back into the Swivel wall material (1) Tighten the ST4.0X8 screws (11) through the fixed cover base (10).

**Note: The maximum adjustment range of the fixed shaft material is 1 inch.**

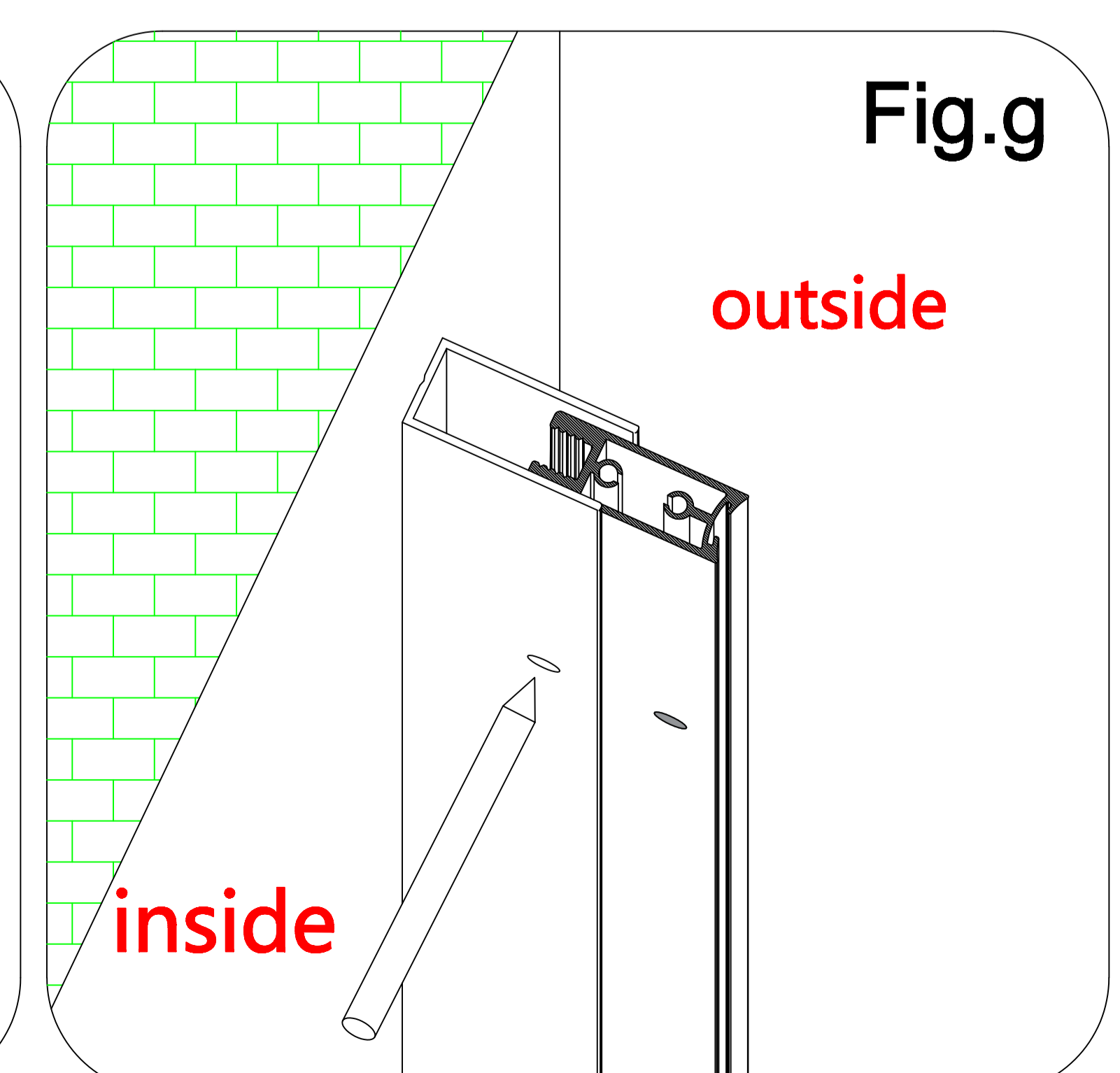
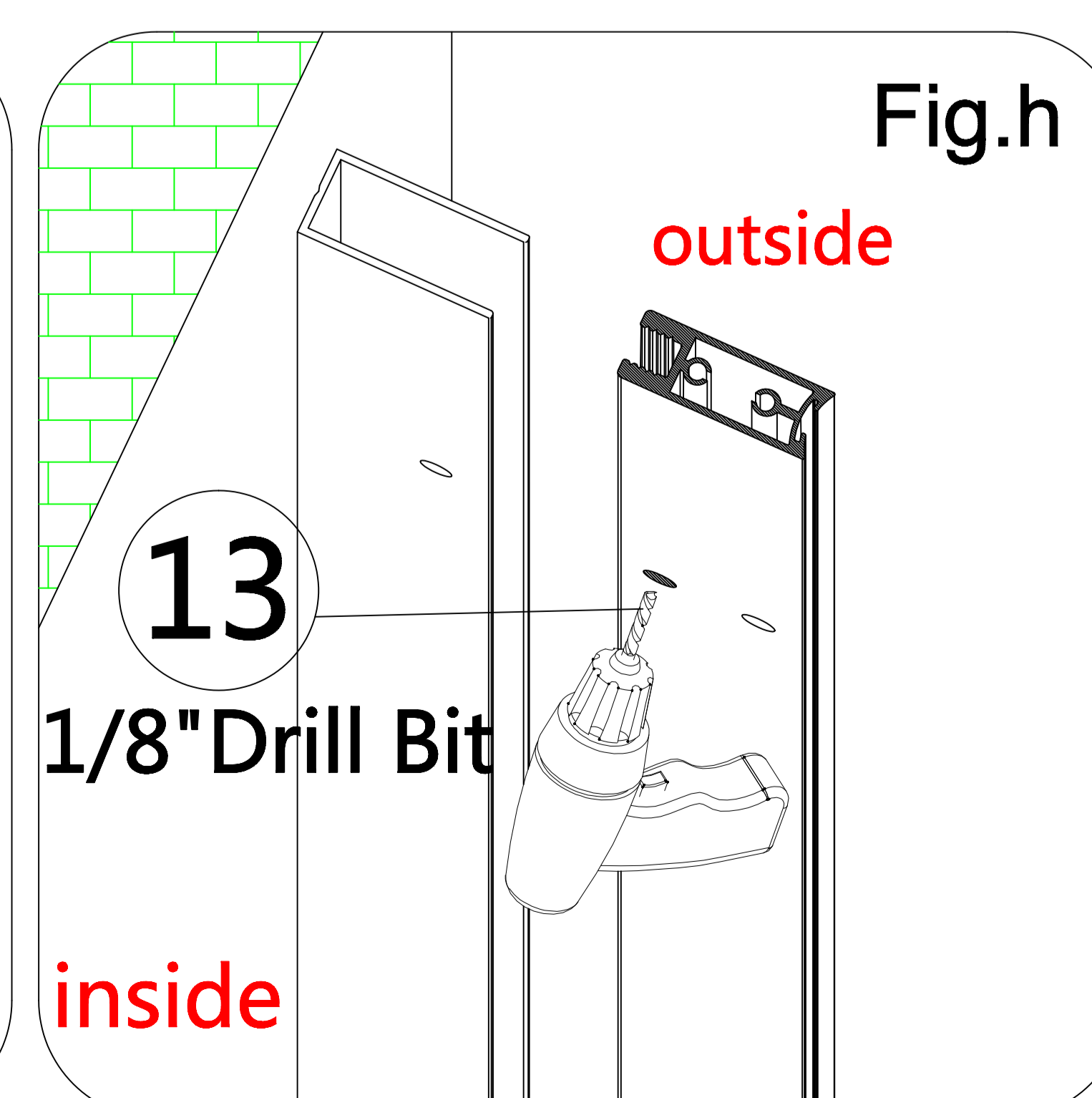
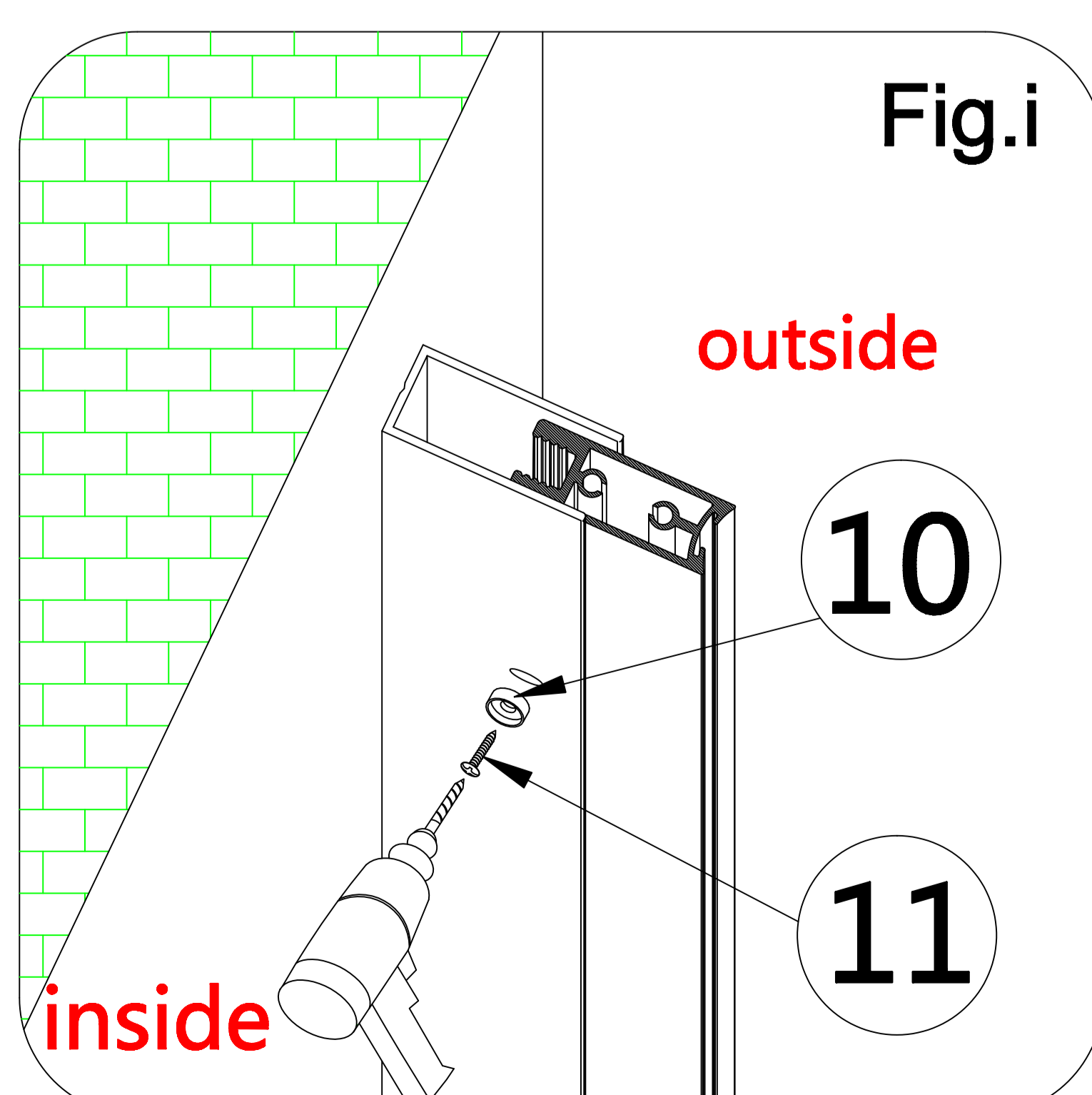
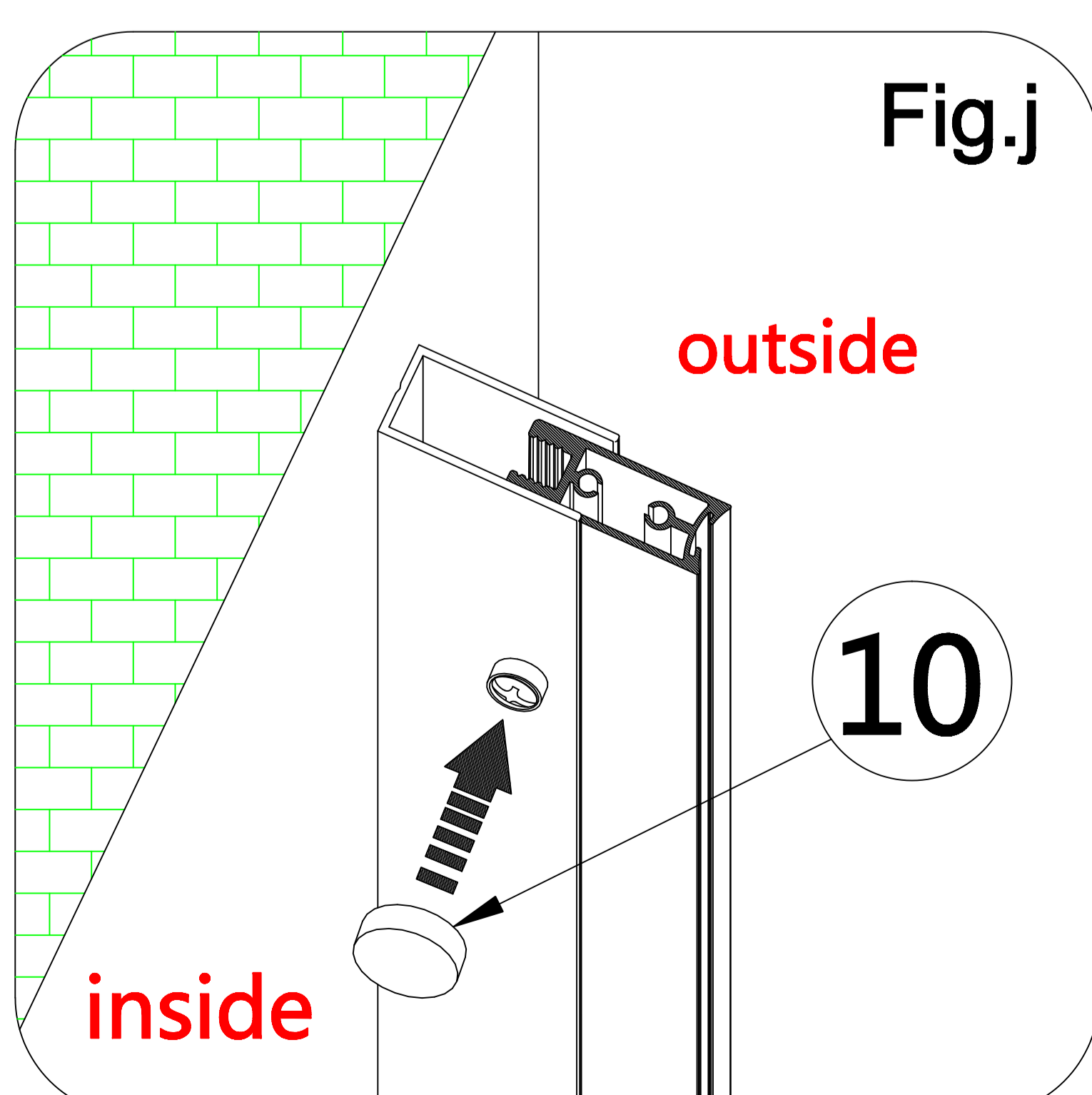
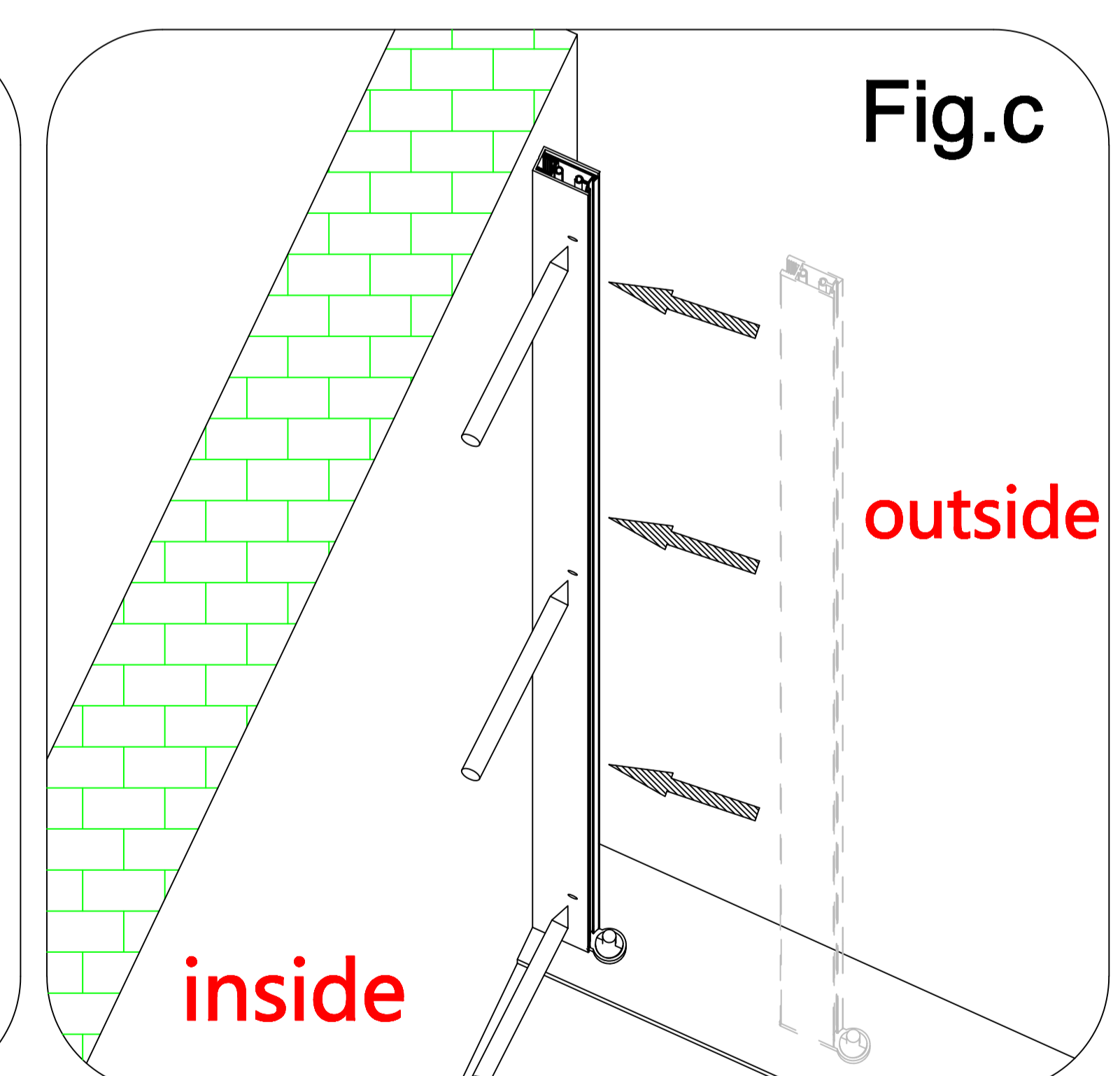
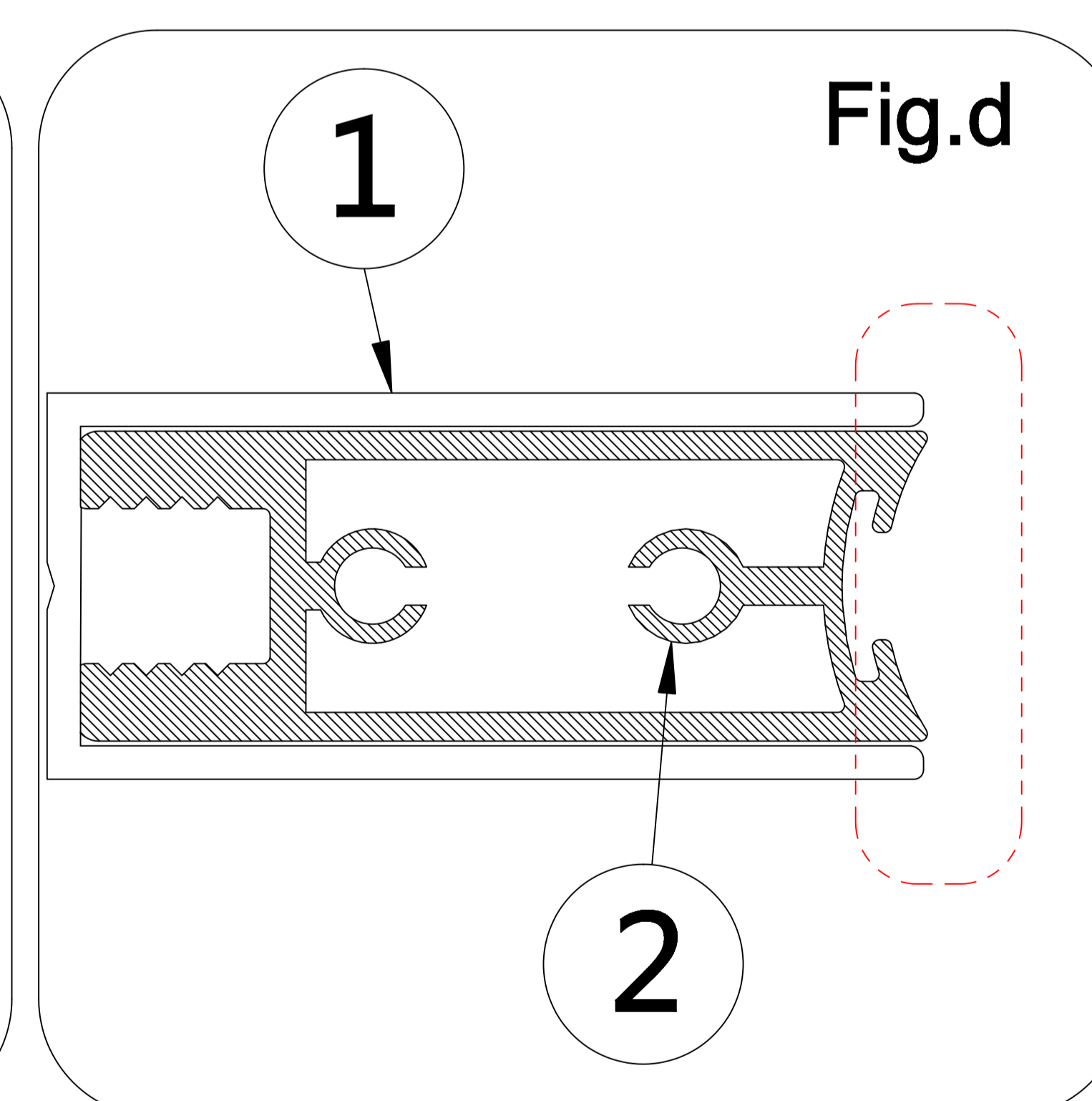
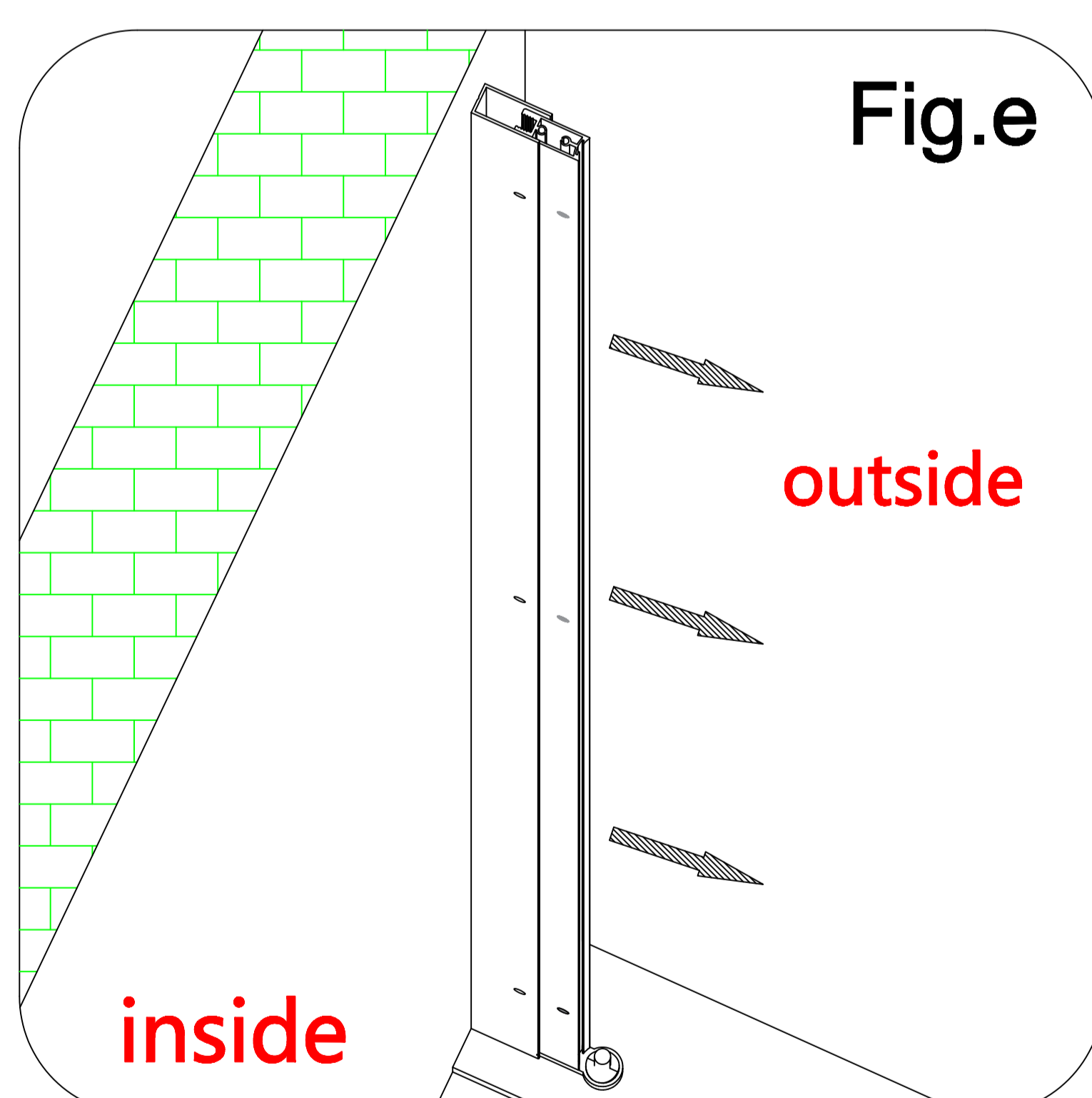
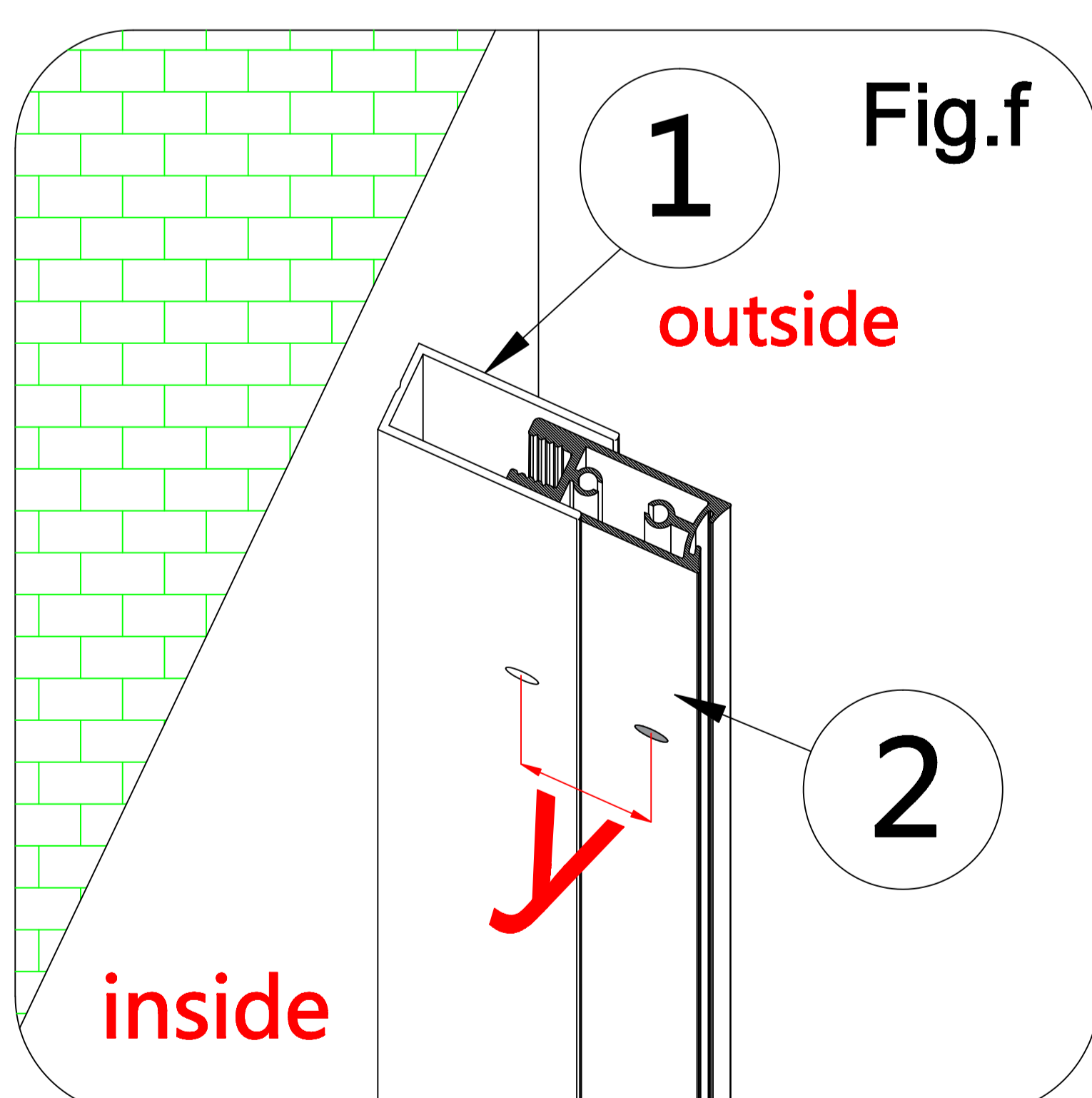
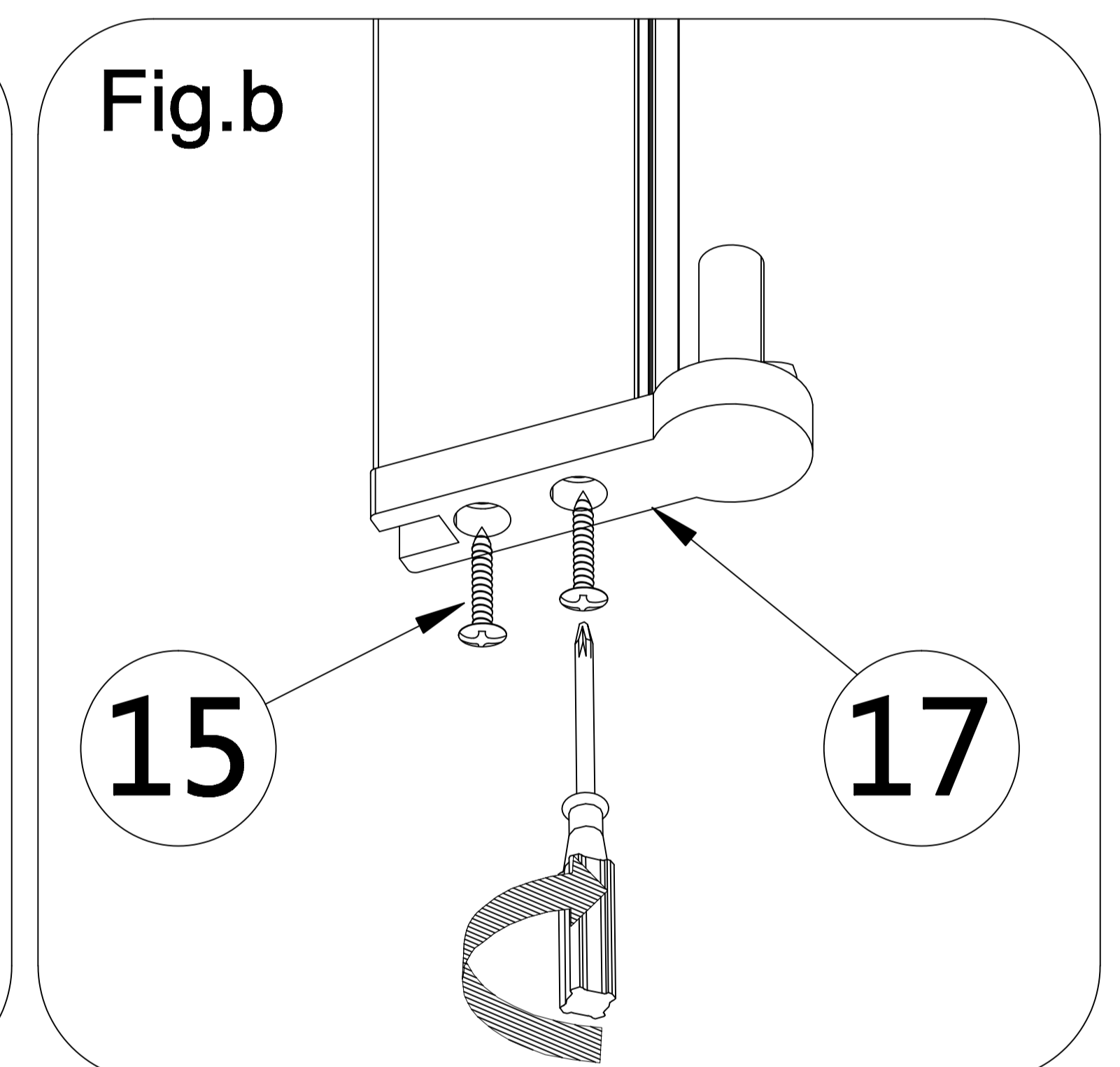
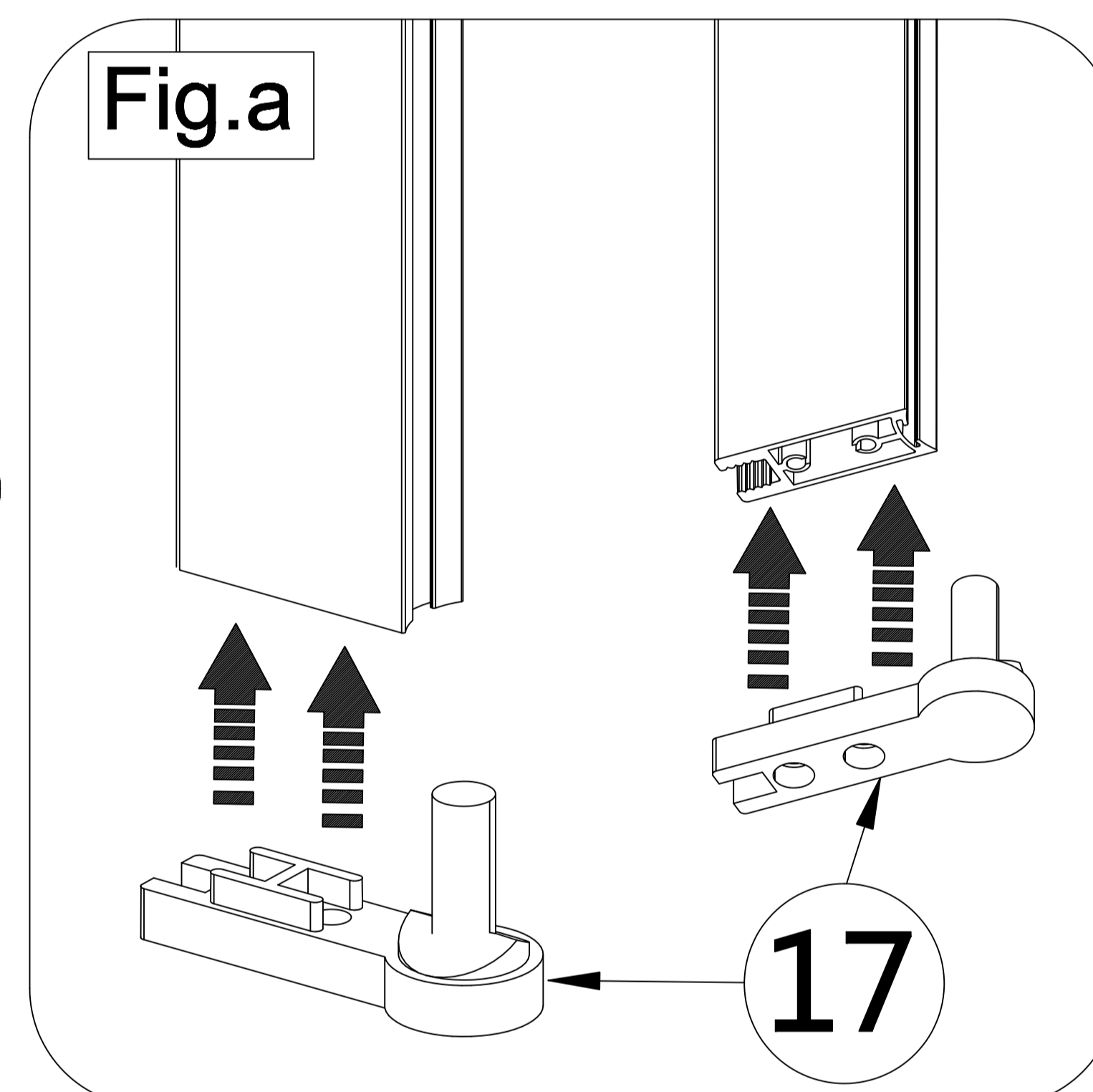
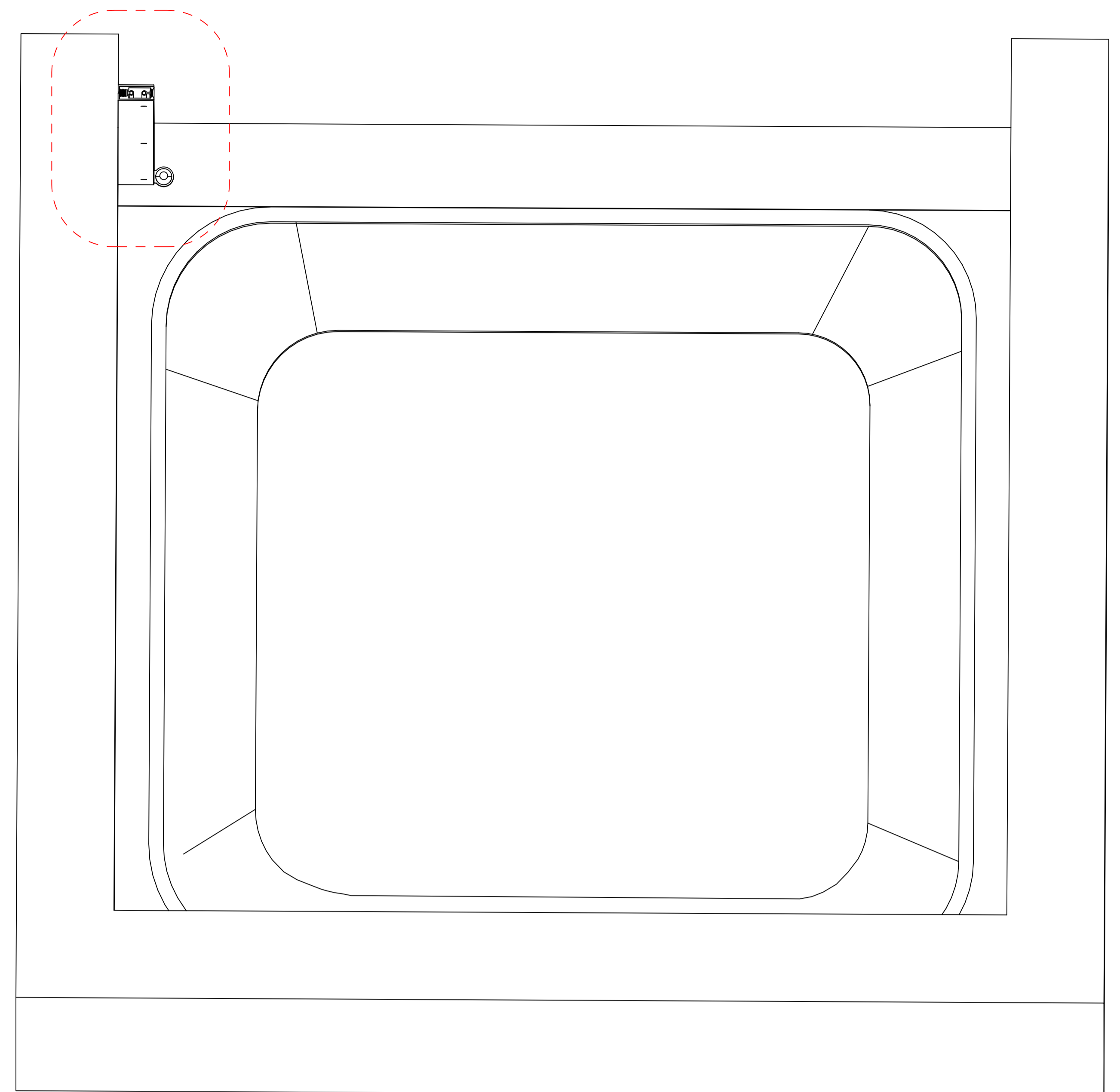

## STEP 3

4. Install Magnetic strip (6) on the glass (4).

**Note:** The swivel wall material is pre-installed with glue on the glass when leaving the factory.

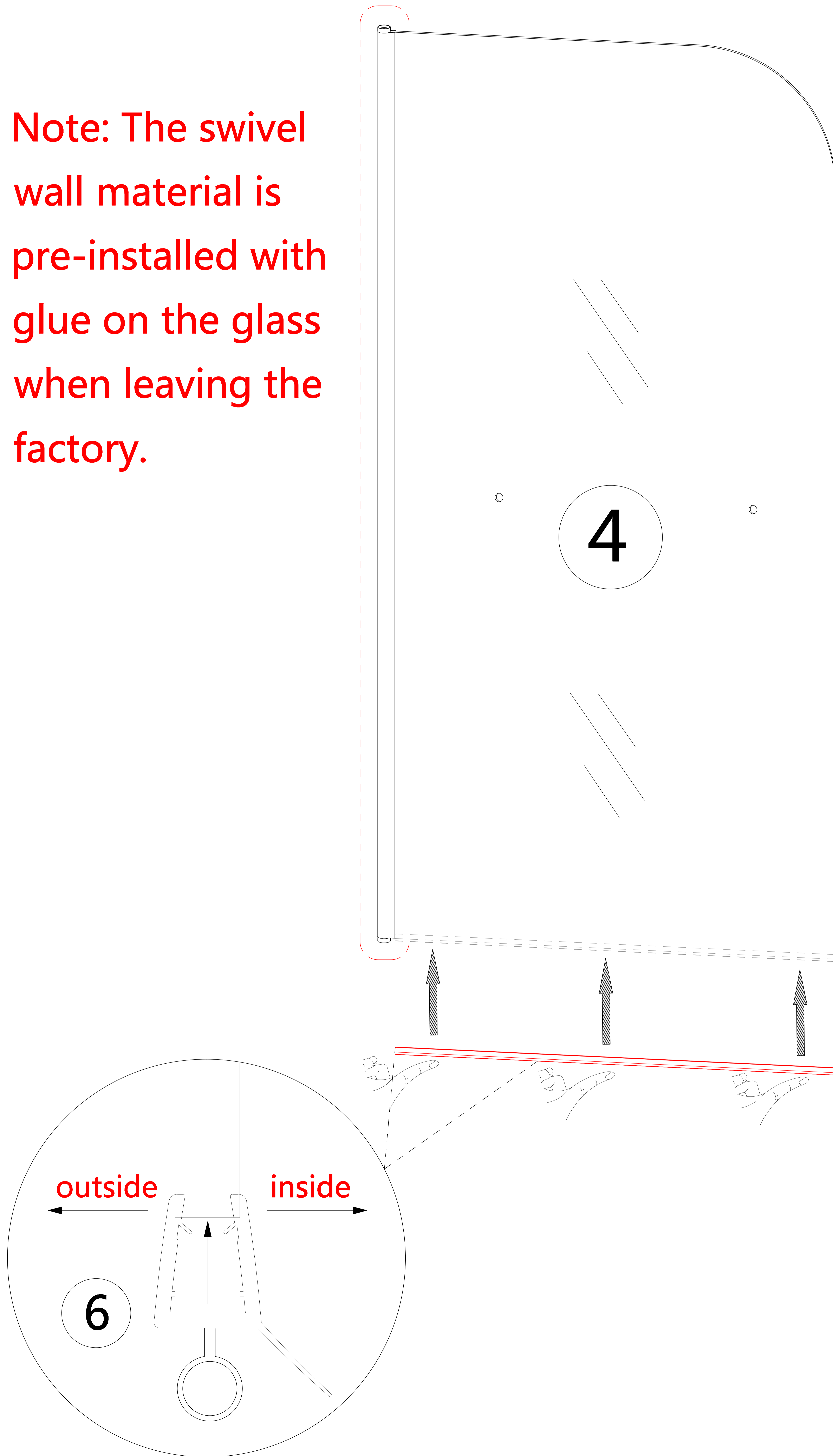

## STEP 3.1

4. Install Magnetic strip (6) on the glass (4).

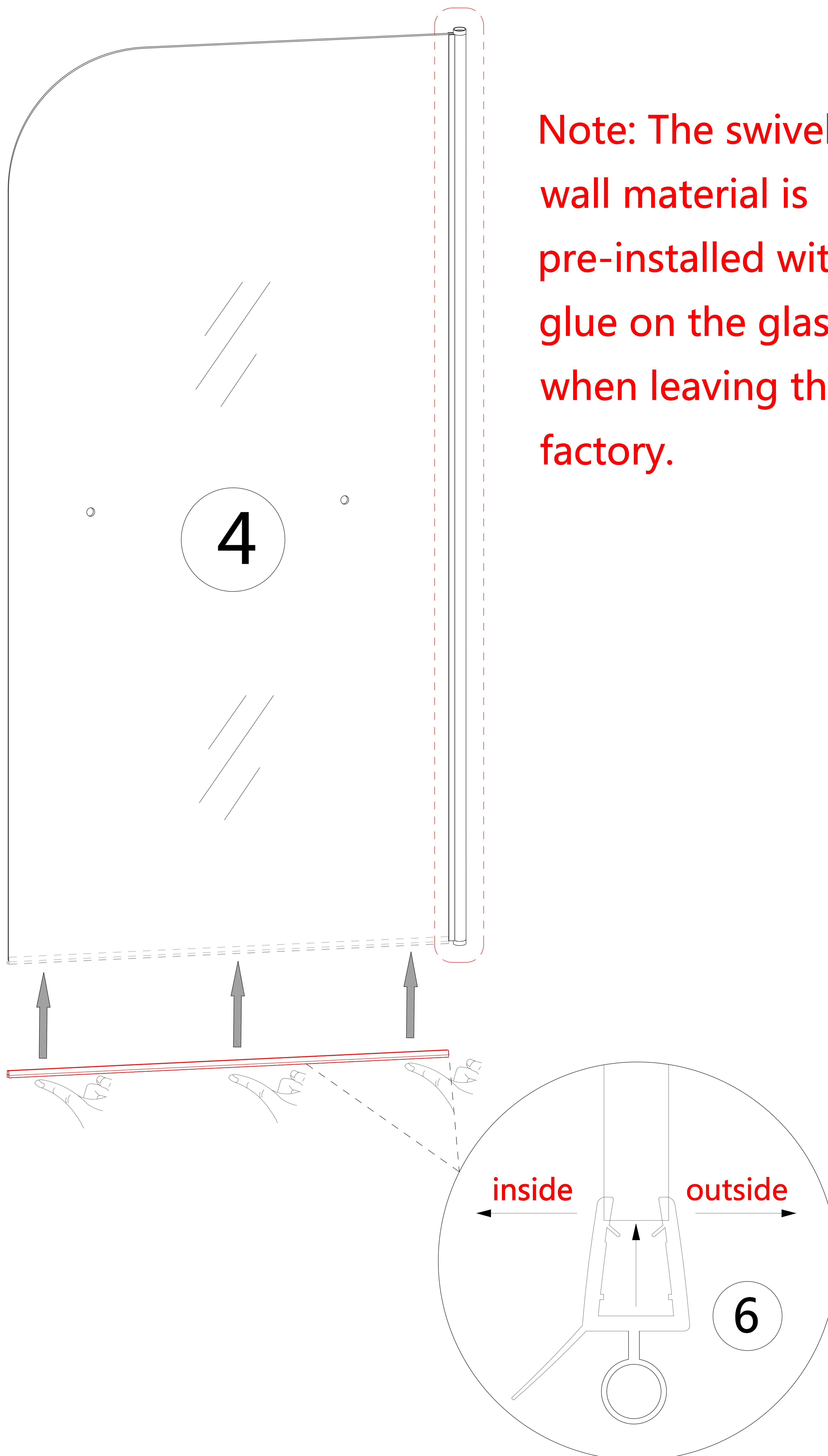

## (Left- hinged door)Active panel installation

### STEP 4

- 1.As shown in Fig.a and Fig.b , Attach the active panel to the hinge.
- 2.As shown in Fig.c and Fig.d , Install the Top lifting shaft (3) with ST4.0X20 screws (12).

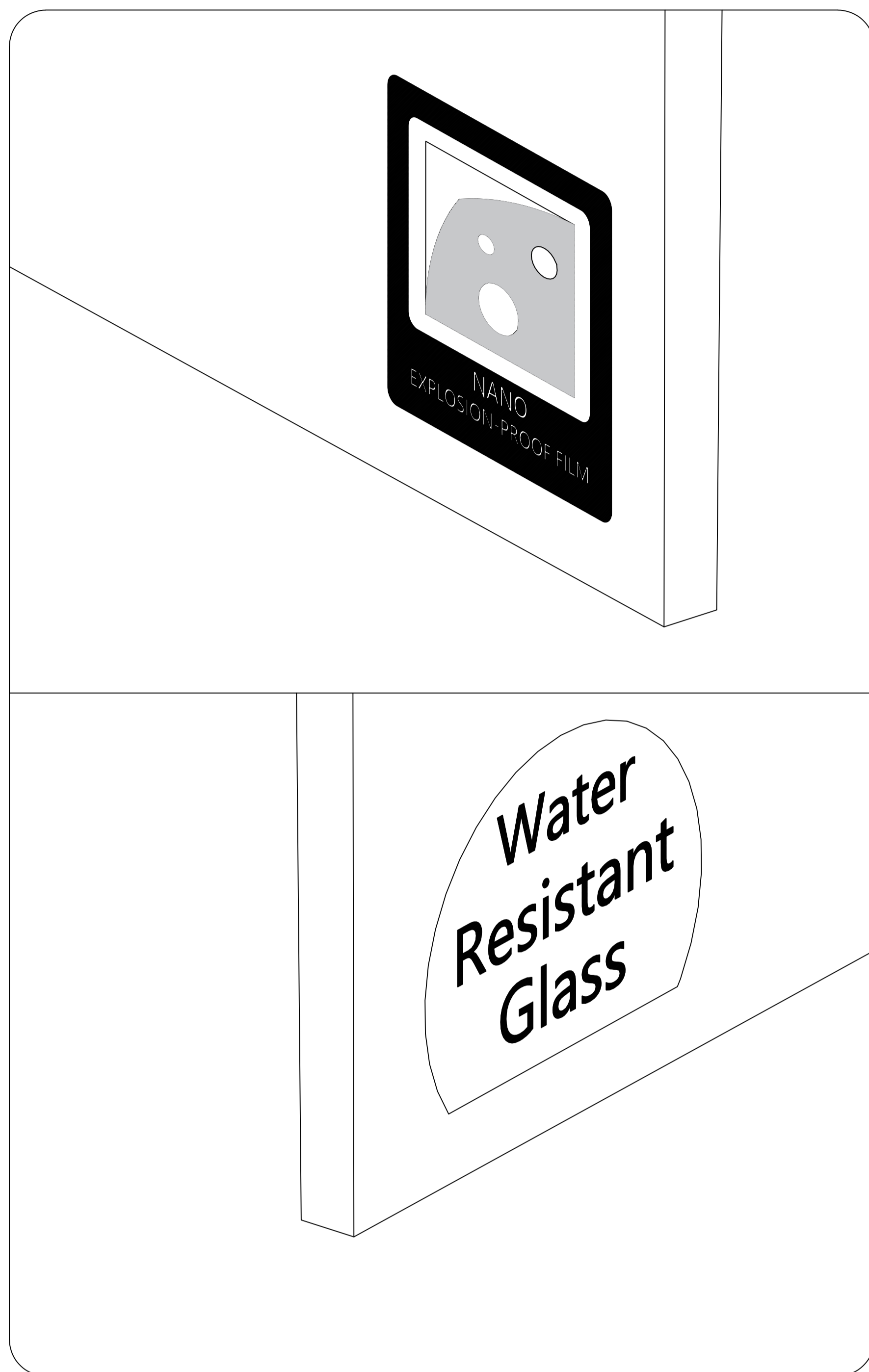

**Note:**The active glass is double-sided nano, and can be freely installed

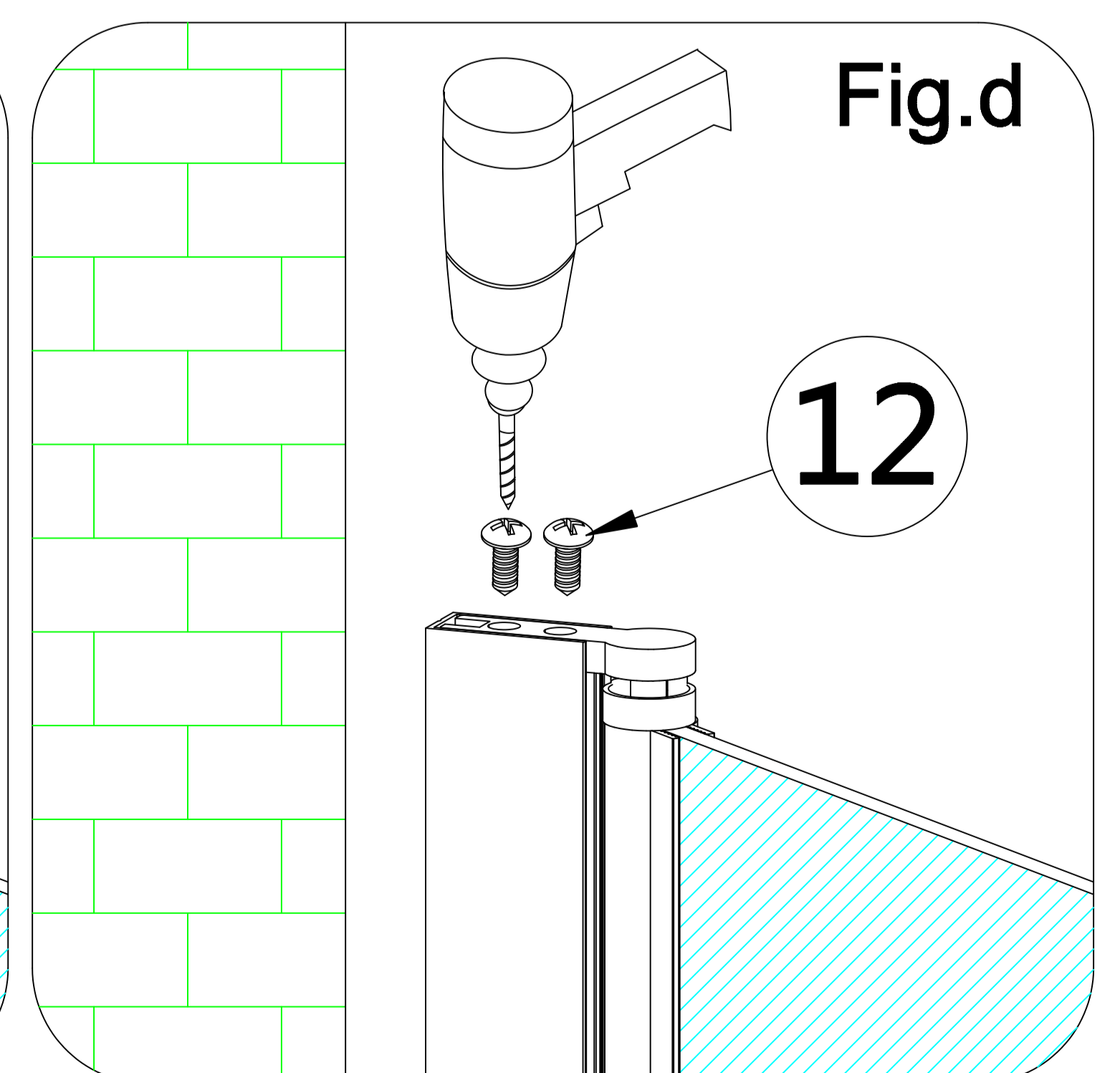
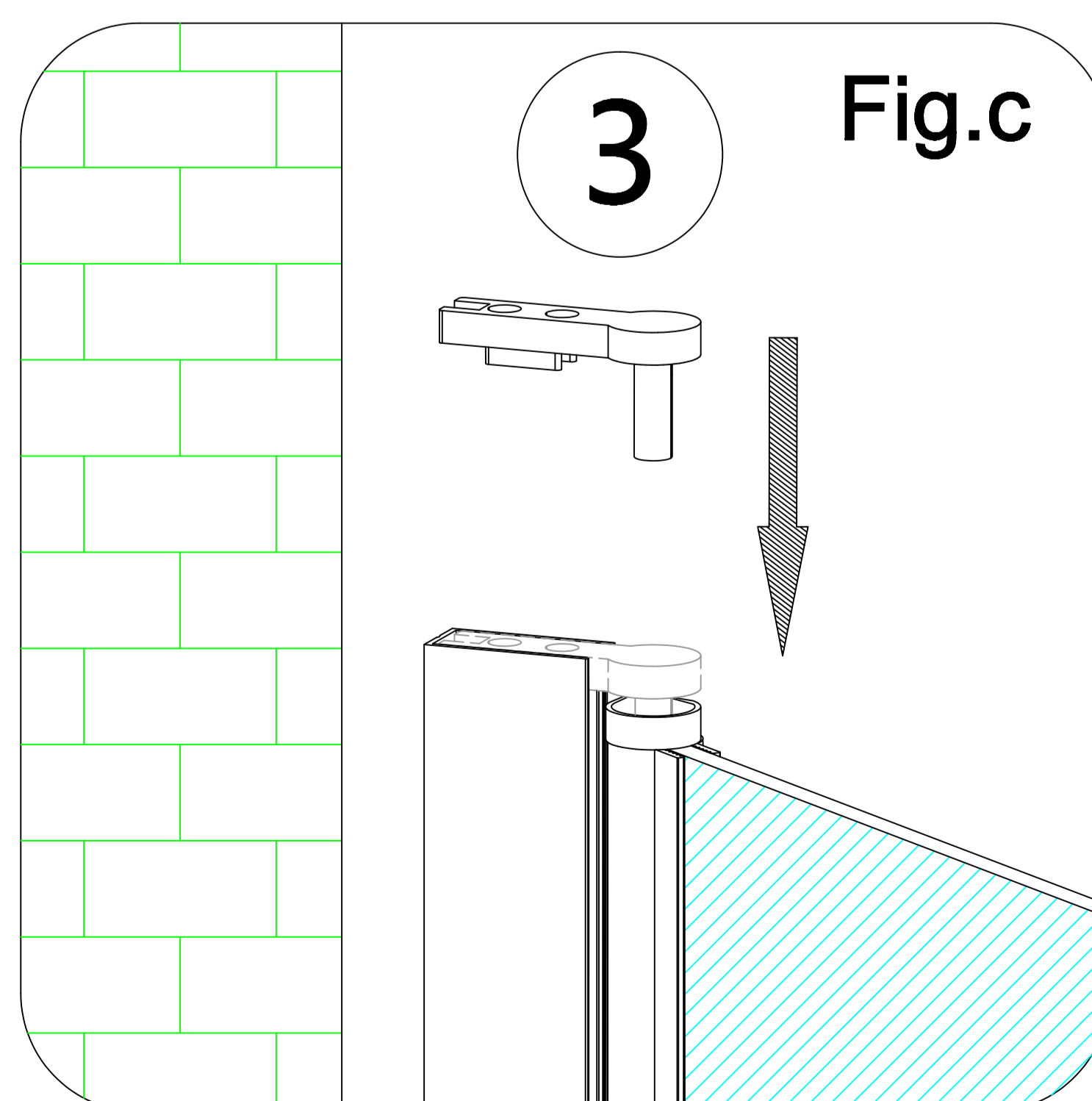
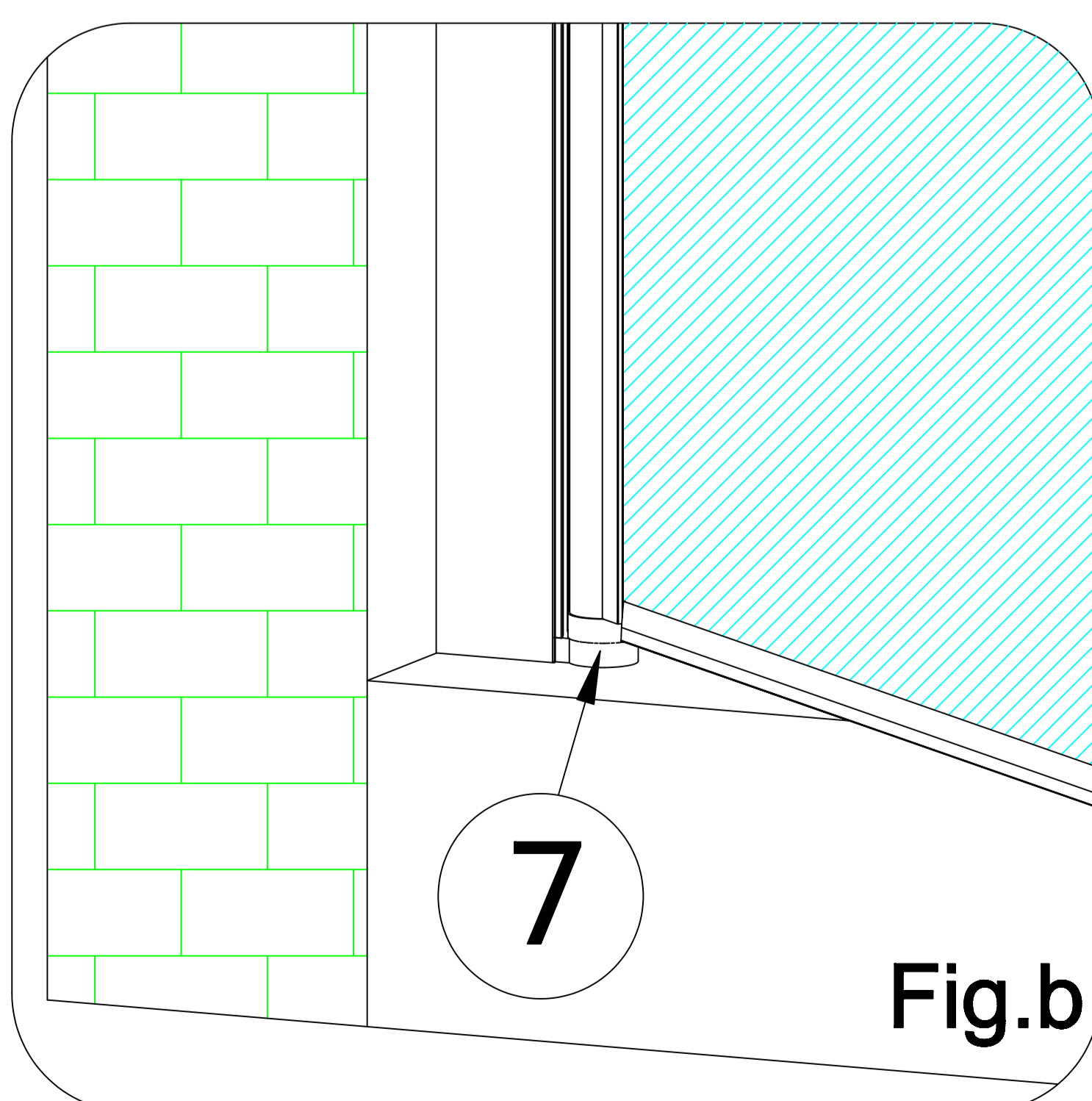
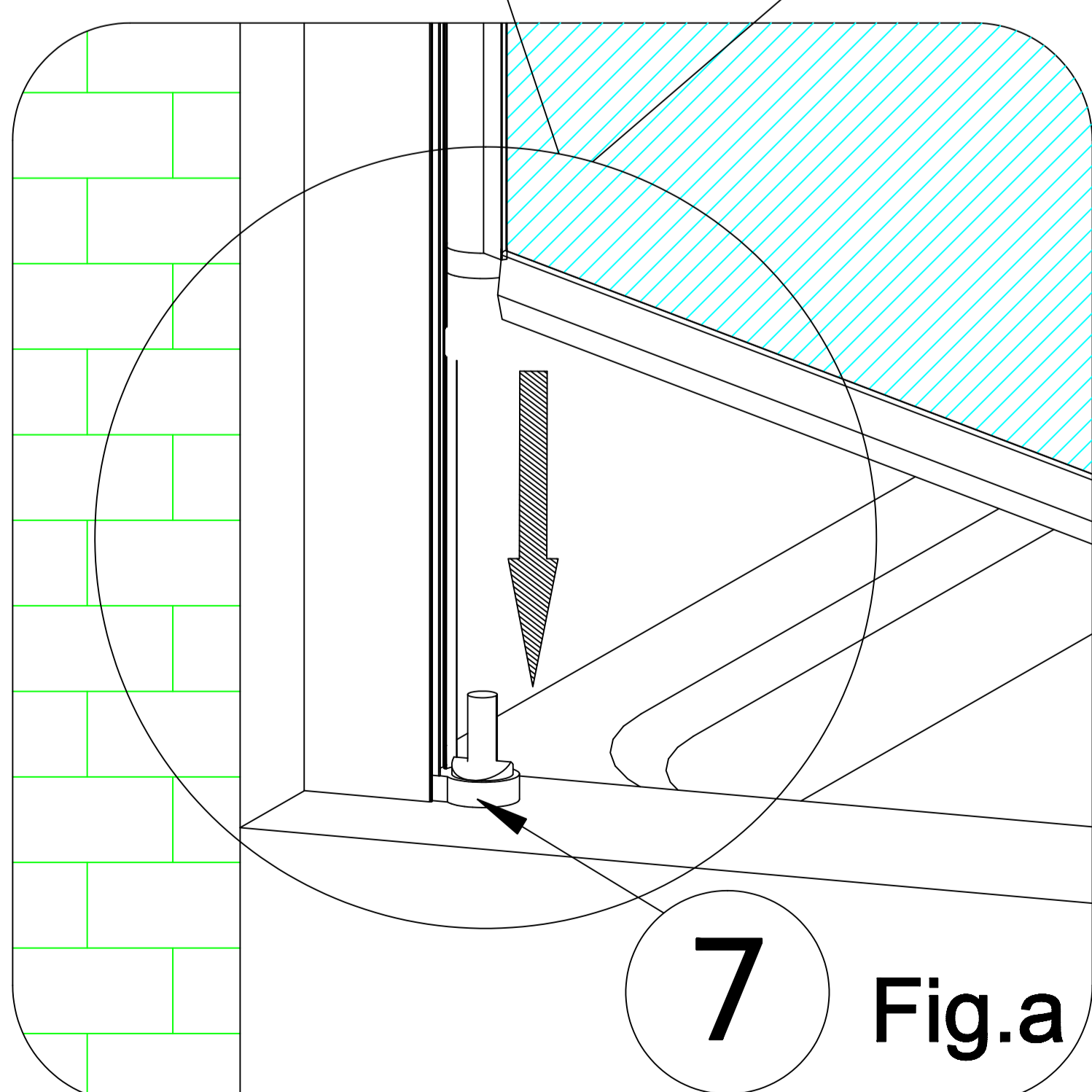
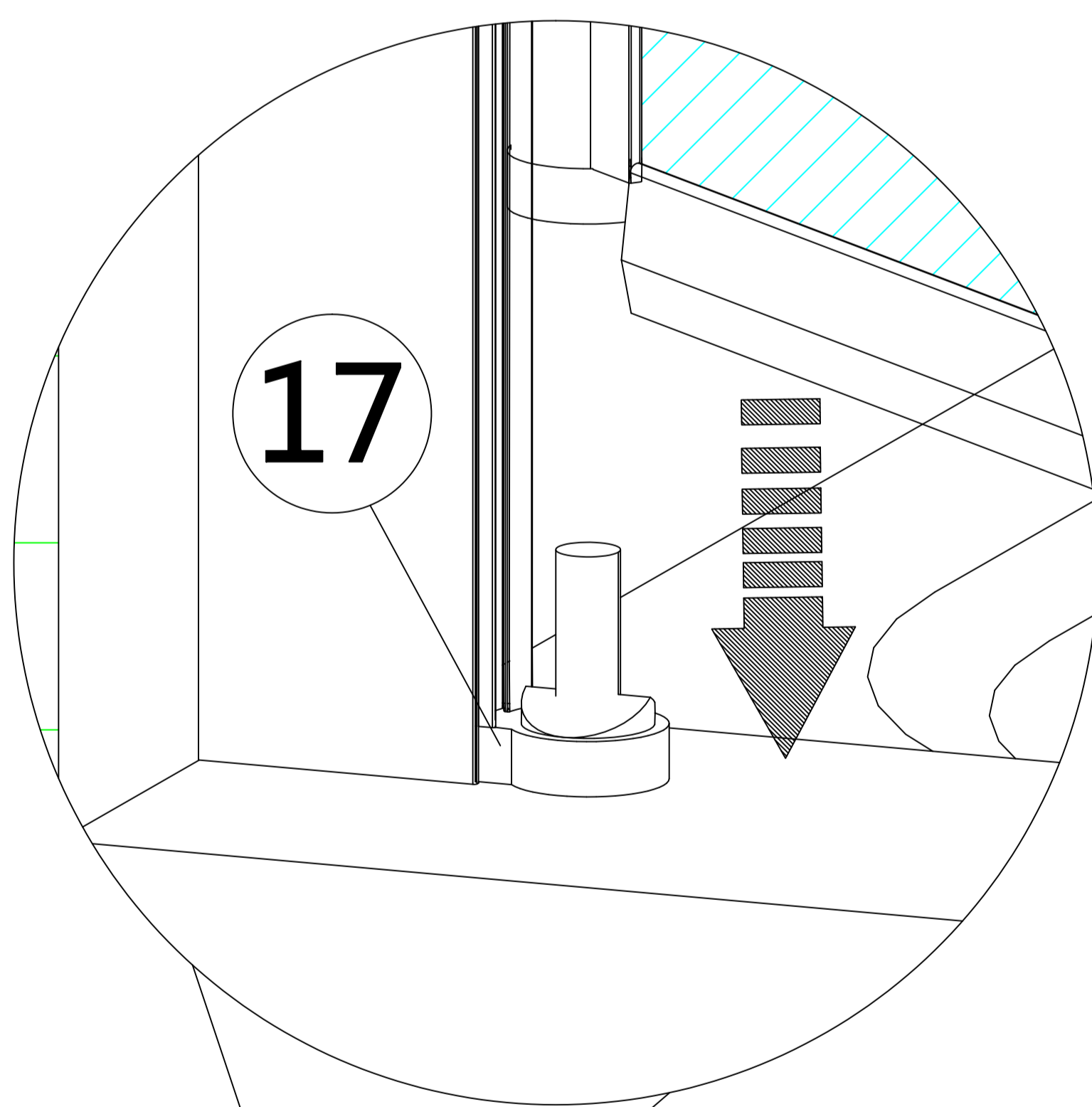
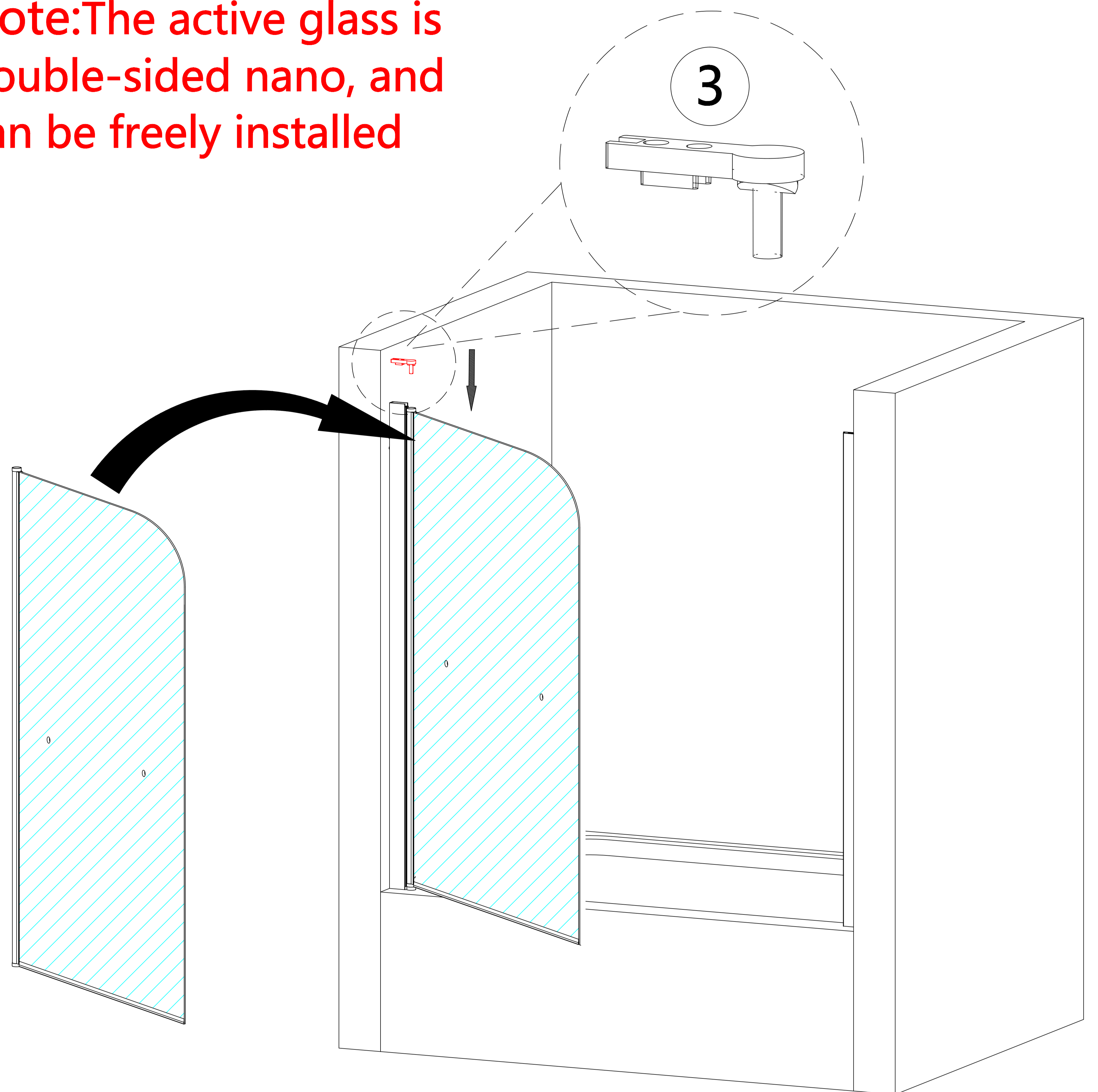

## (Right- hinged door) Active panel installation

### STEP 4.1

- 1.As shown in Fig.a and Fig.b , Attach the active panel to the hinge.
- 2.As shown in Fig.c and Fig.d , Install the Top lifting shaft (3) with ST4.0X20 screws (12).

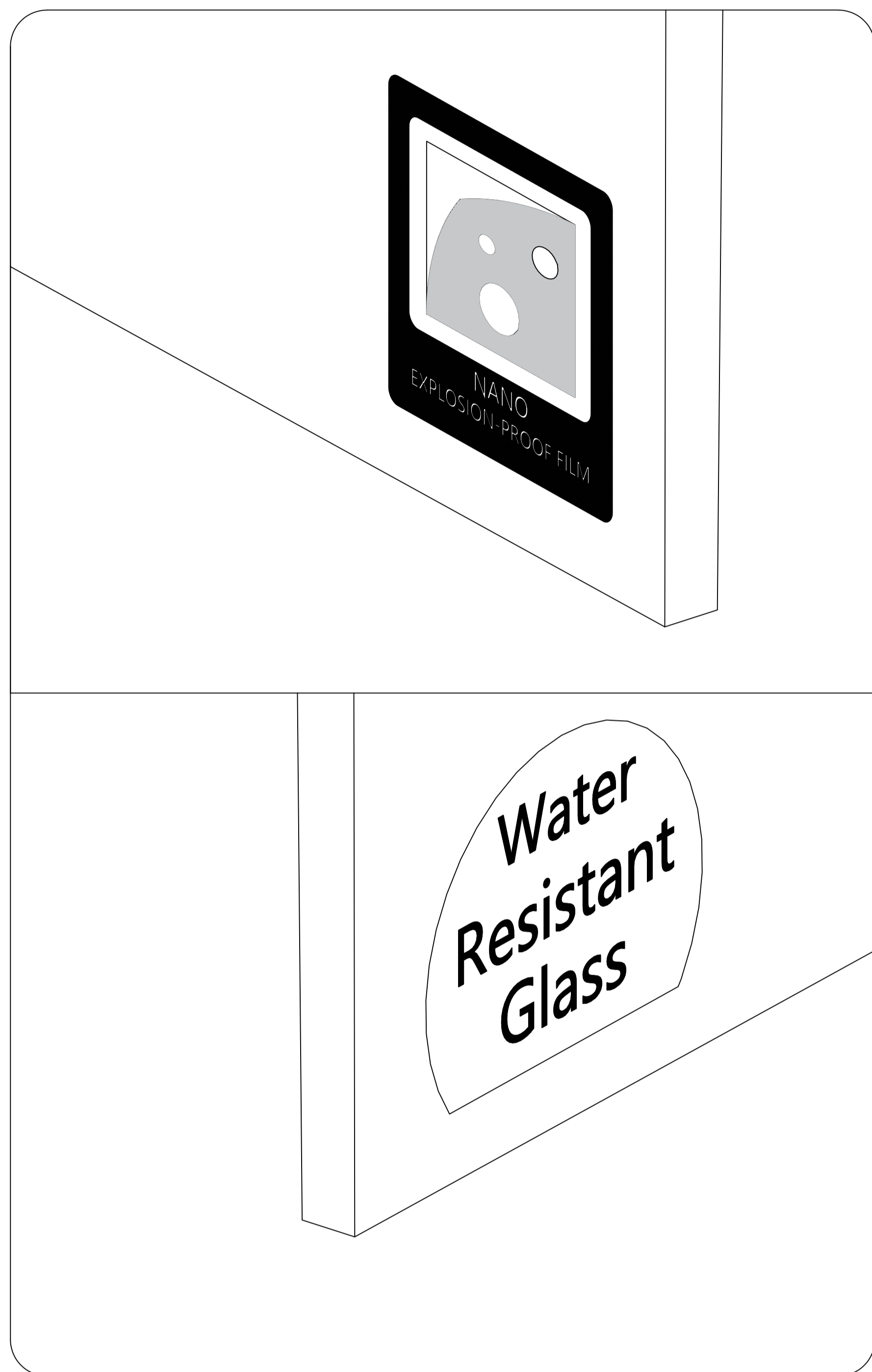

**Note:**The active glass is double-sided nano, and can be freely installed

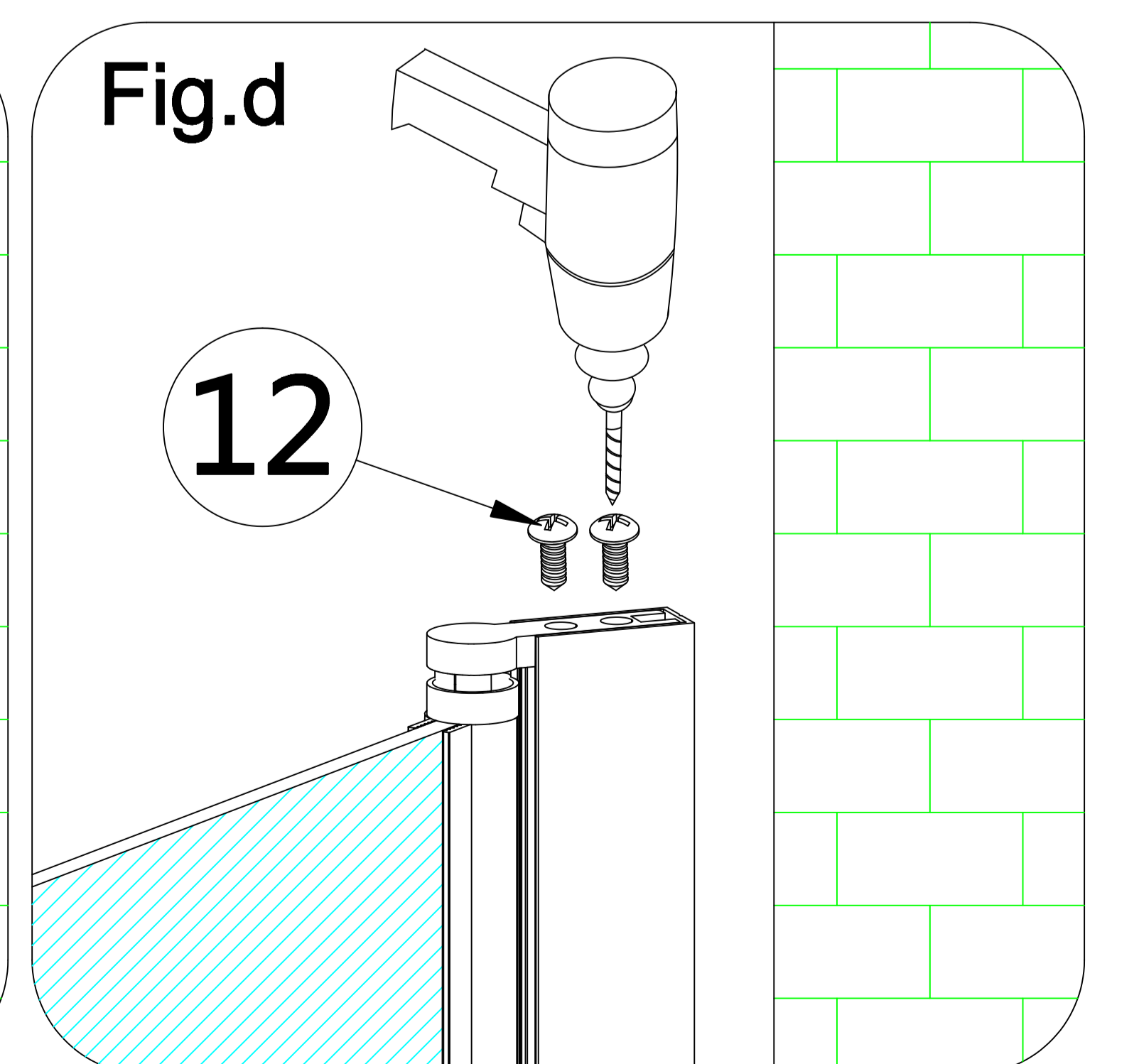
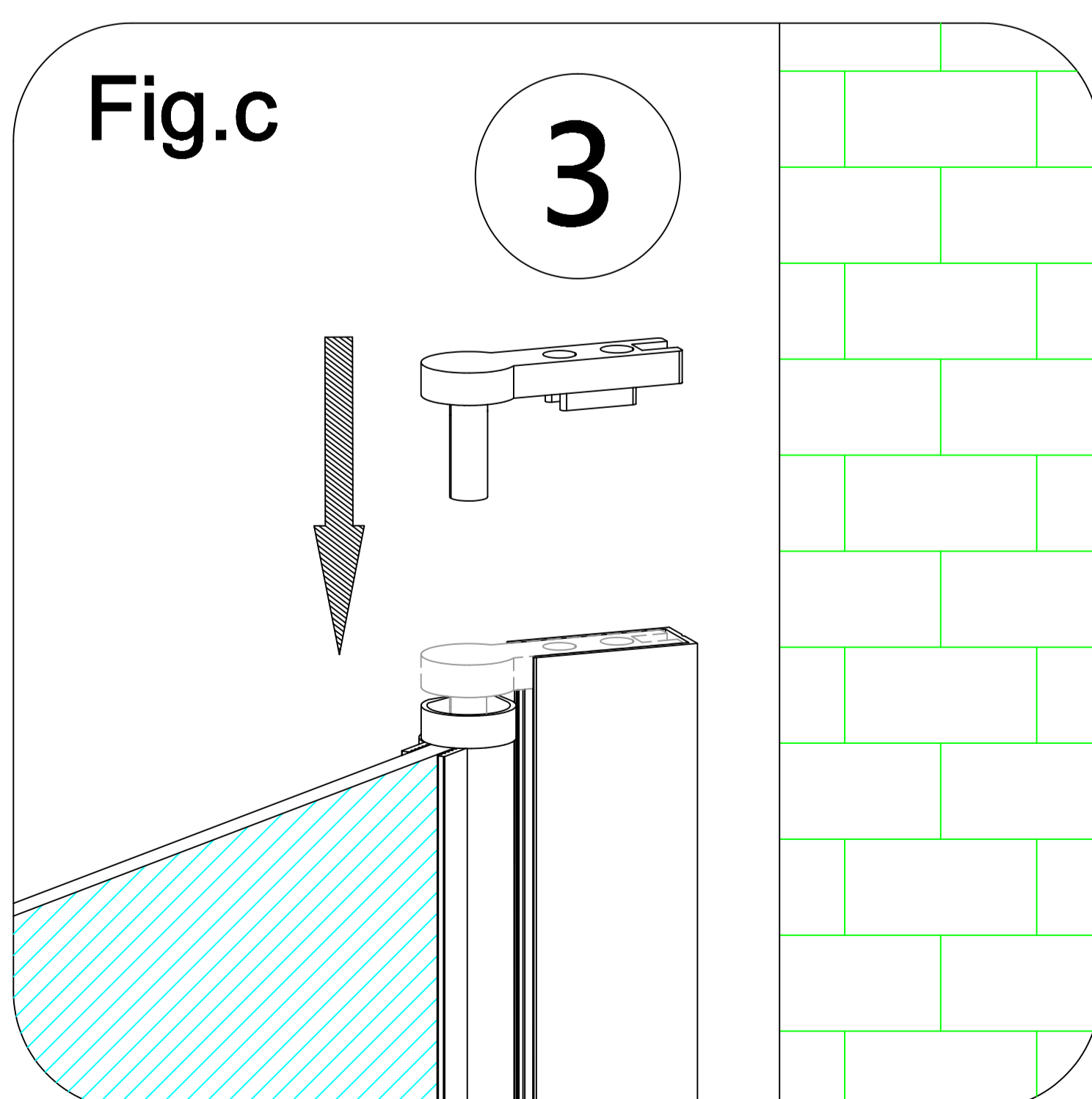
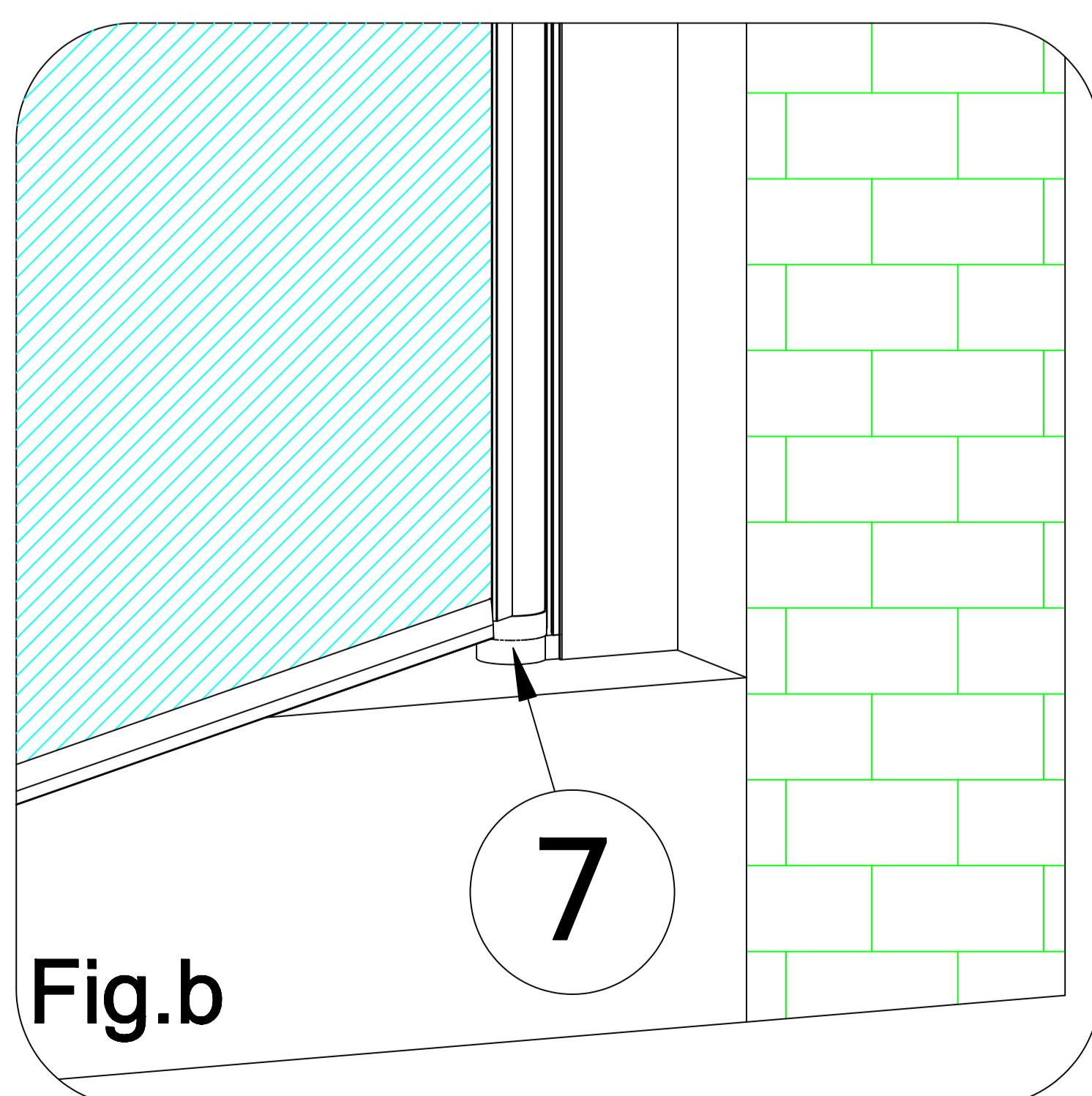
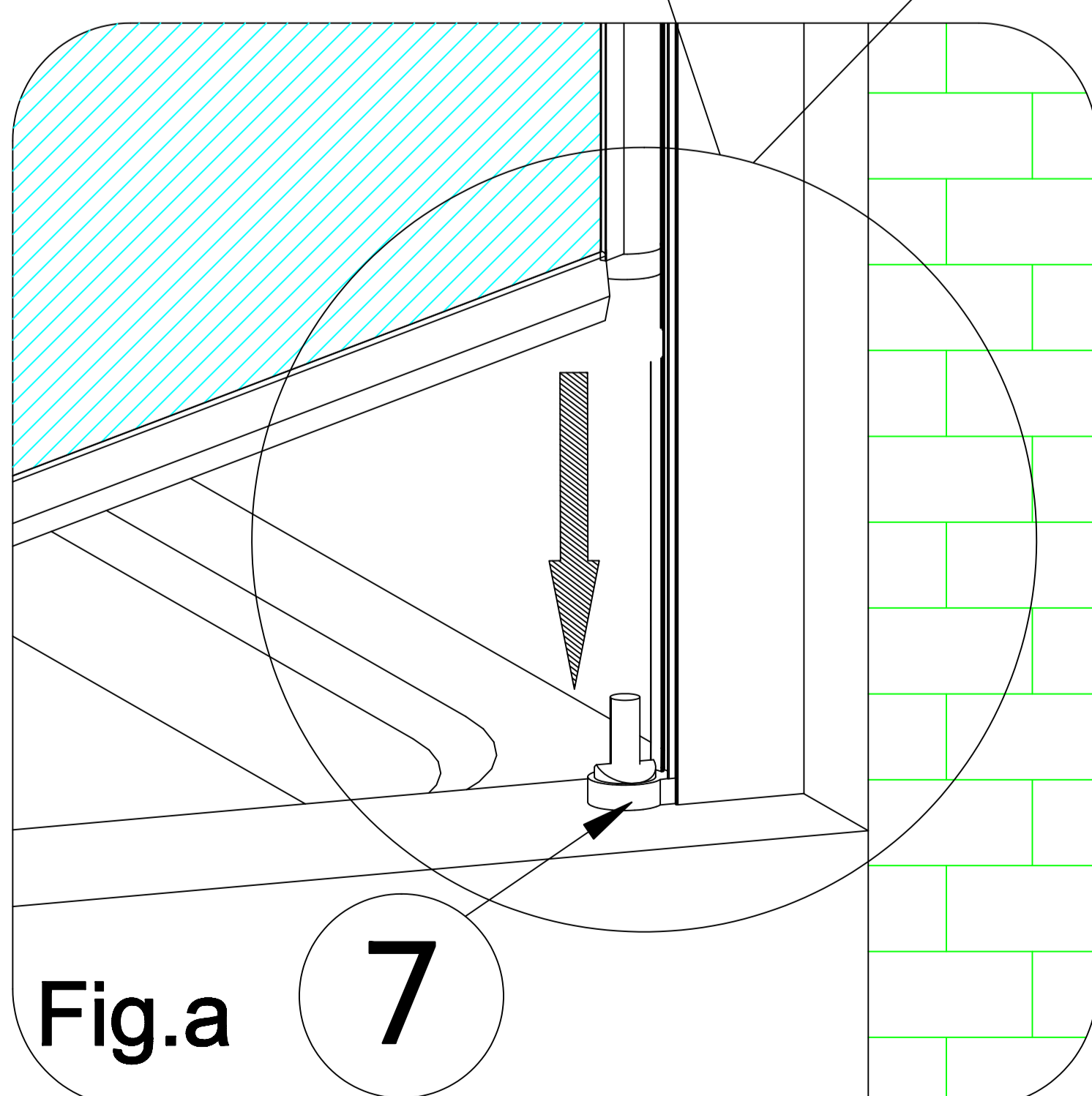
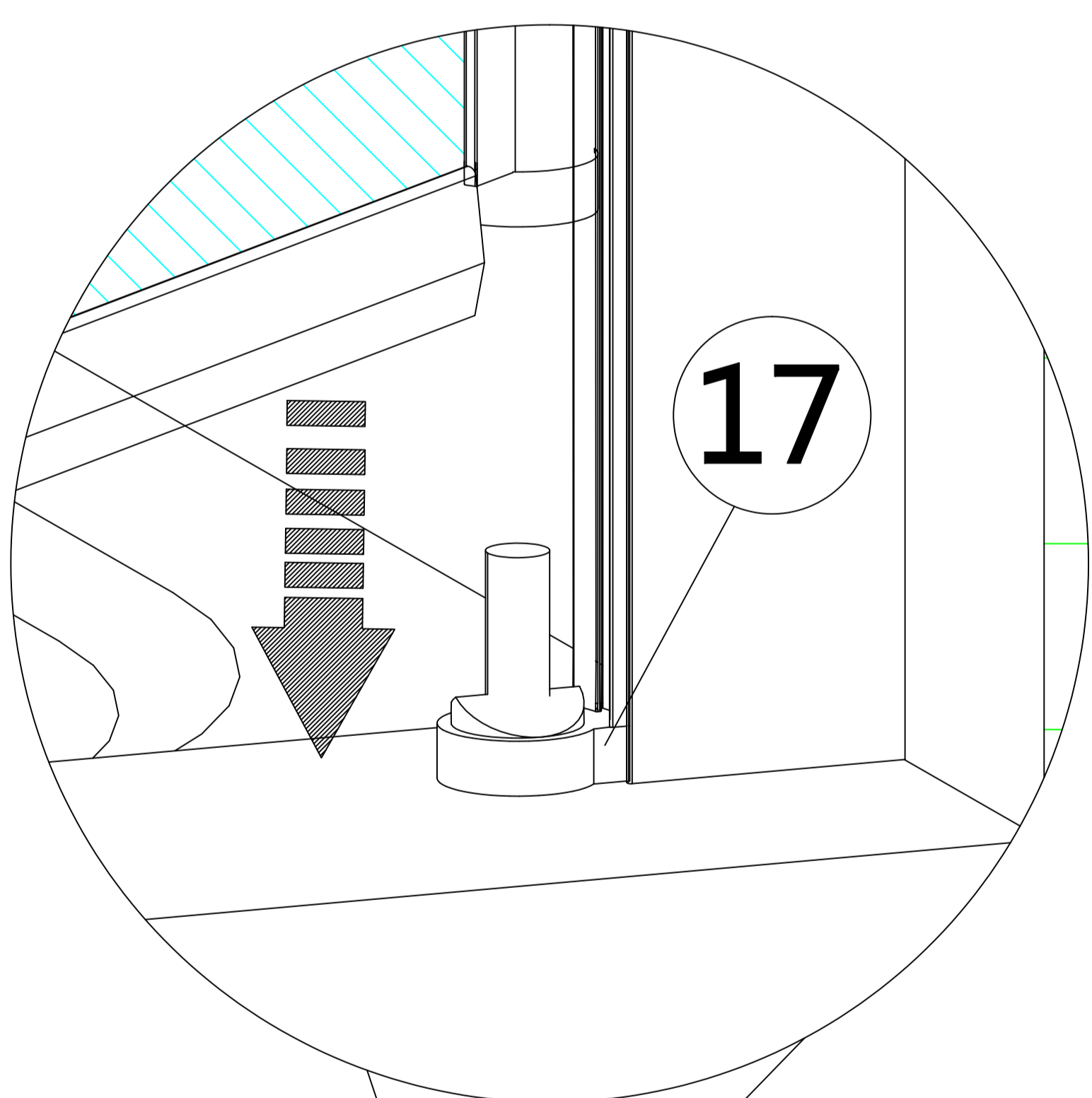
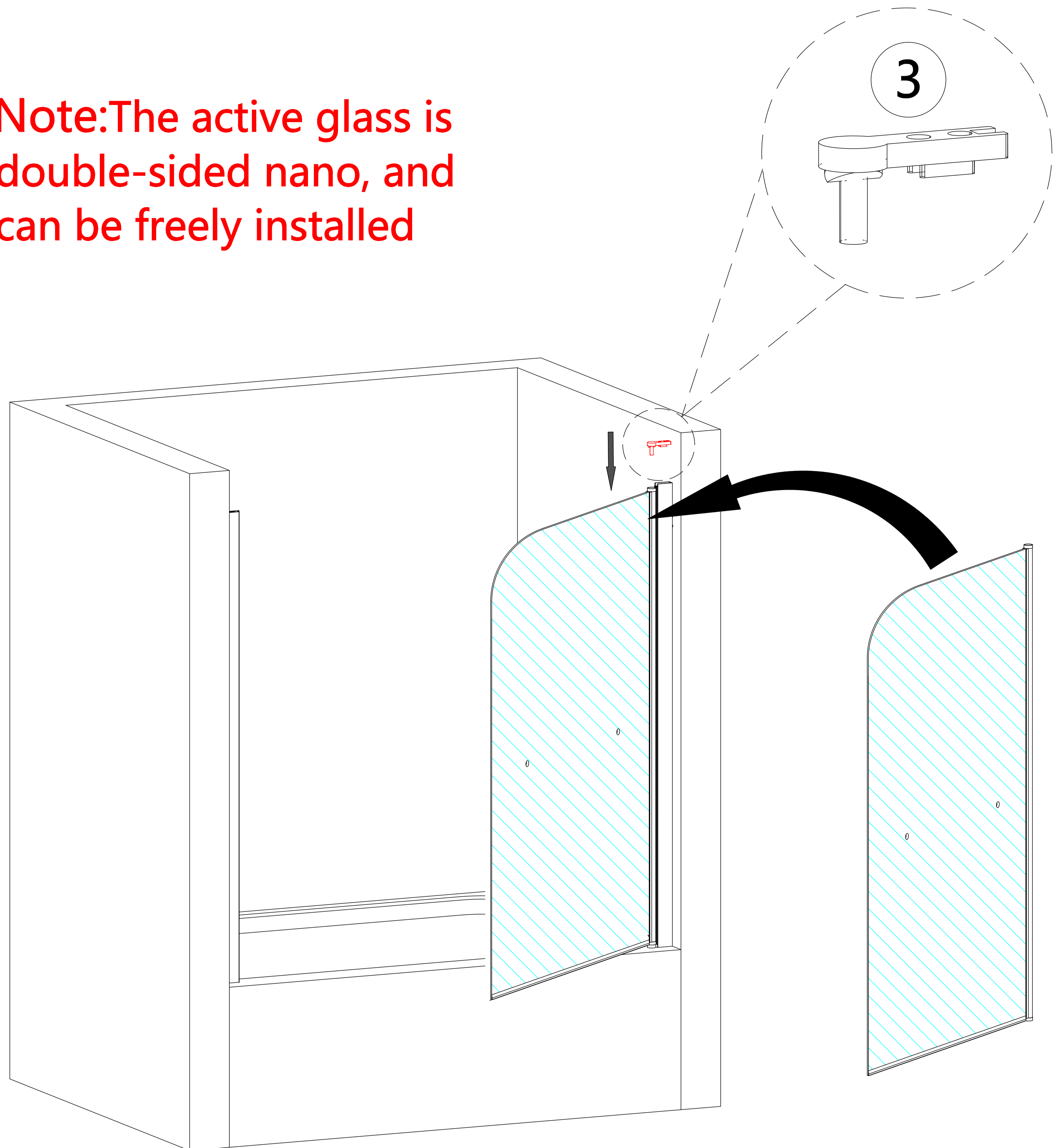

(Left- hinged door)Handle installation

**STEP 5**

1. Install the Handle (5)  
on the glass (4).

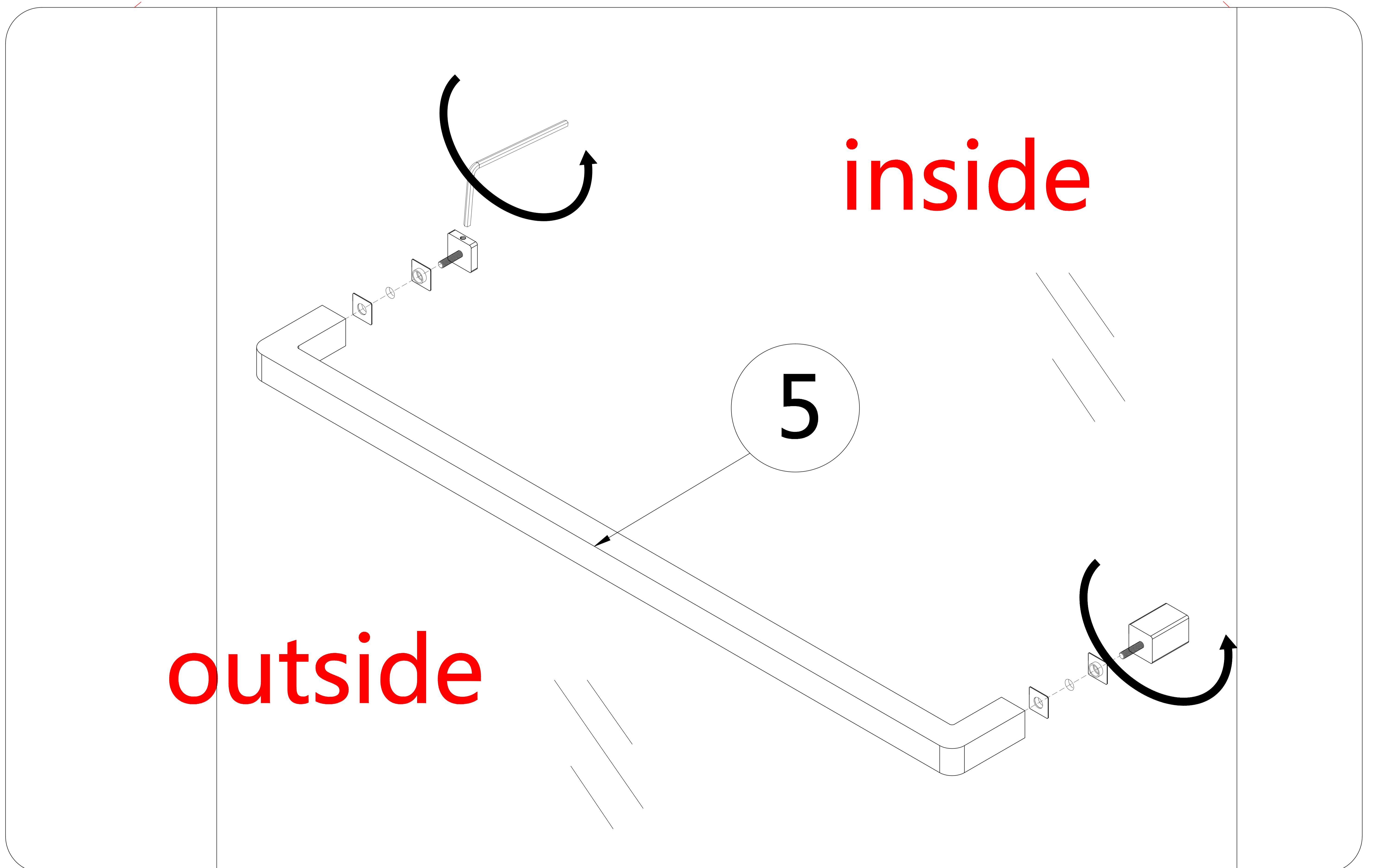
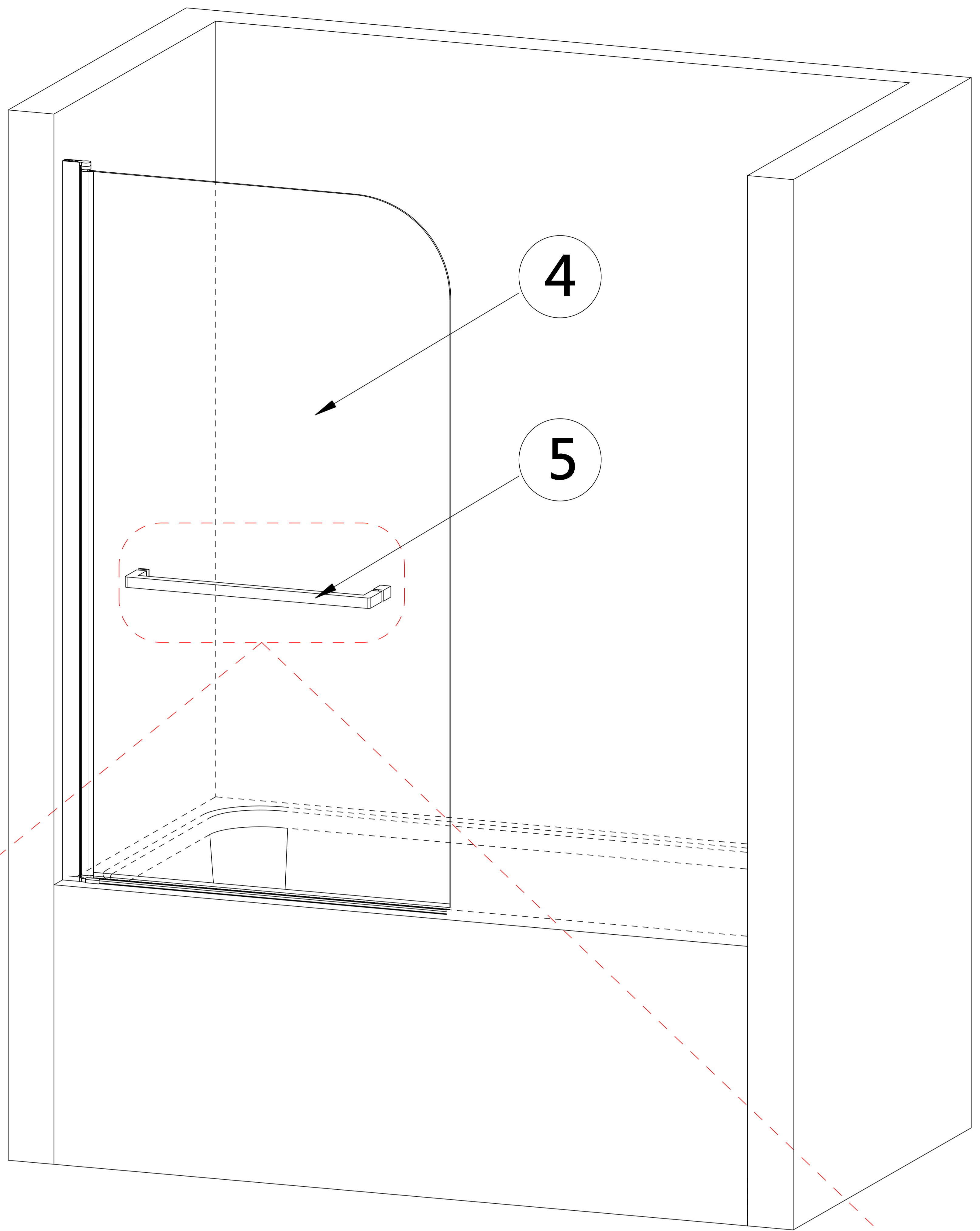

(Right- hinged door)Handle installation

**STEP 5.1**

1.Install the Handle (5)  
on the glass (4).

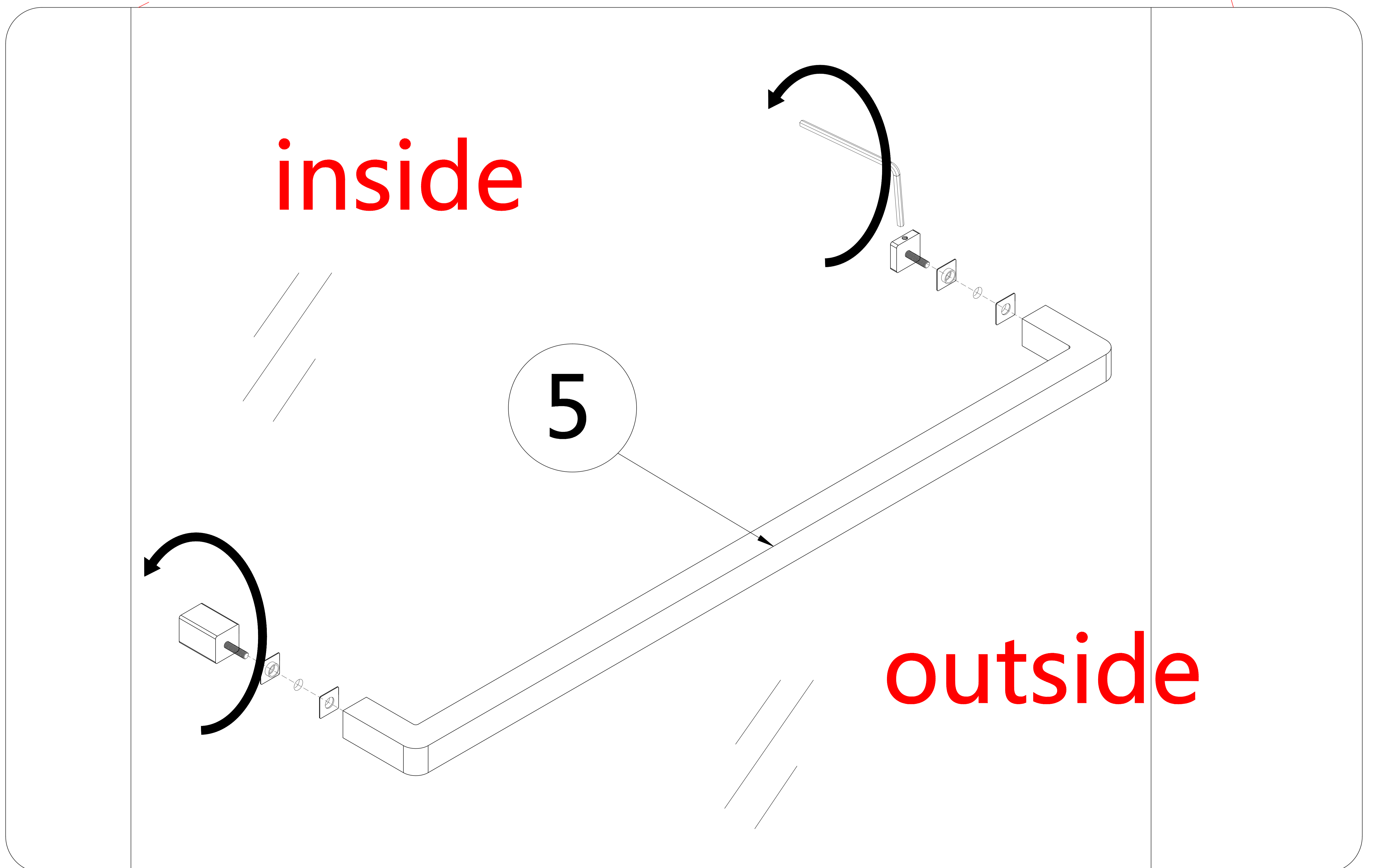
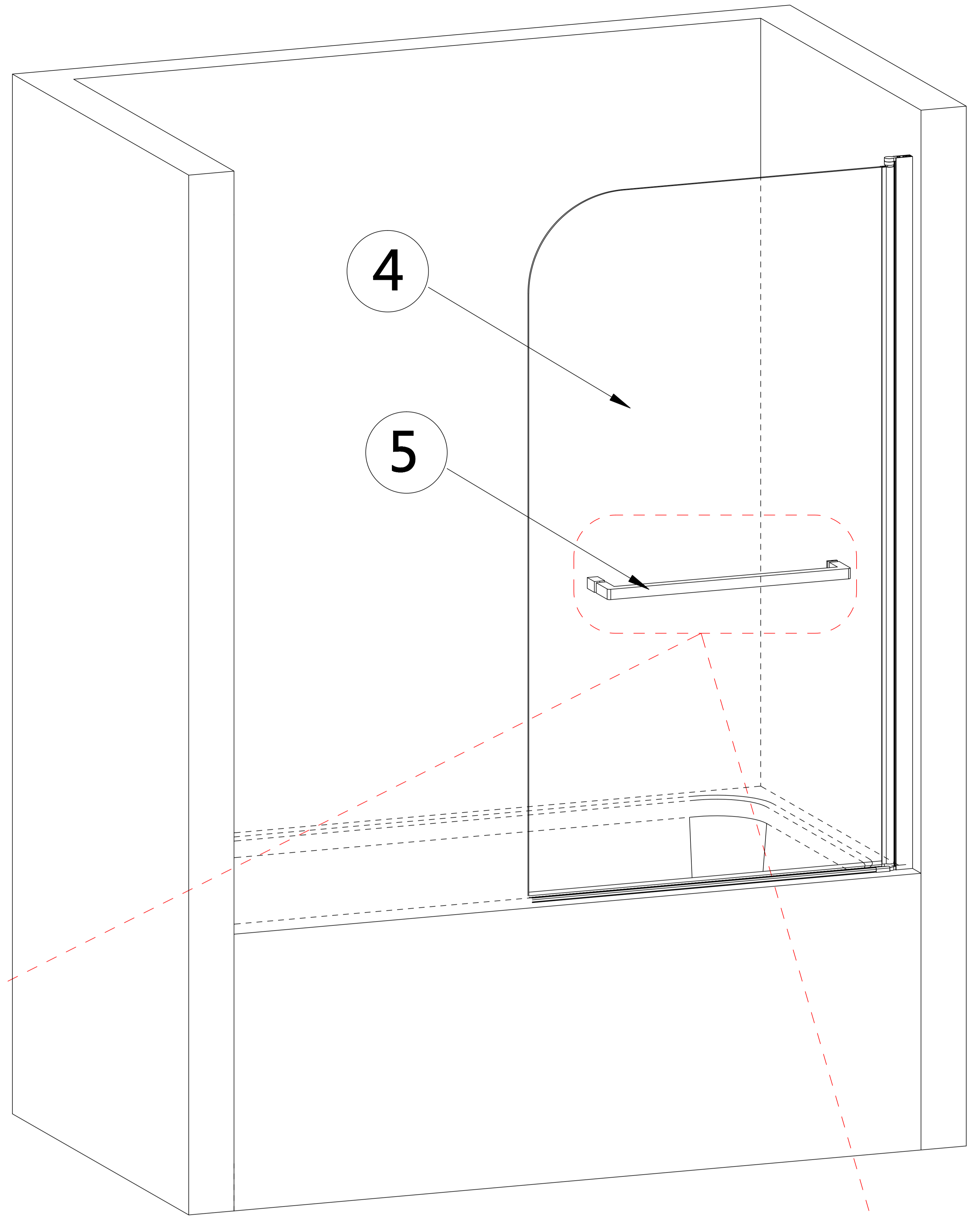

# Seal with glass glue and precautions

## STEP 6

- 1.The surface needs to be kept clean and free of debris before applying the glass glue.
- 2.Apply glass glue to seal the frame.
- 3.Wait 24 hours for the glass glue to dry before using the shower door.

