

ASSEMBLY INSTRUCTION

Power Double Reclining Love Seat with Center Console, Wireless Speakers, LED and Charging Ports



Hardware are stored in box, please take out for assembly.

NOTE: Do not use power tools for assembly. Power tools increase the risk of over tightening which lead to splitting or cracking the wood.

COMPONENT LIST

NO.	Sketch	QTY	Description	NO.	Sketch	QTY	Description
A		1 PC	Seat	E		1 PC	Left EAR
B		1 PC	Left Backrest	F		1 PC	Right EAR
C		1 PC	Right Backrest	G		1 PC	chair adaptor
D		1 PC	Console Backrest	H		1 PC	Speaker adaptor
I		2 PCS	Female bracket				

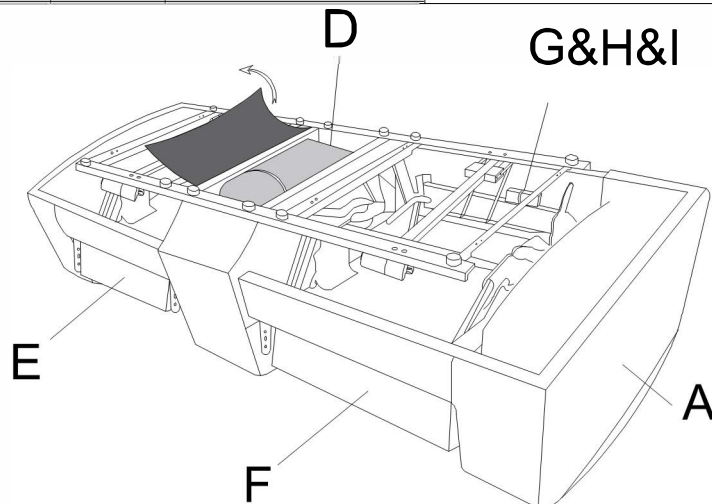

ASSEMBLY INSTRUCTION

Power Double Reclining Love Seat with Center Console, Wireless Speakers, LED and Charging Ports

STEP 1:

Align metal bracket on back to the base, push to the end to secure in position.
 NOTE: Console backrest(D) is packed in the bottom of base. Please take out for assembly.

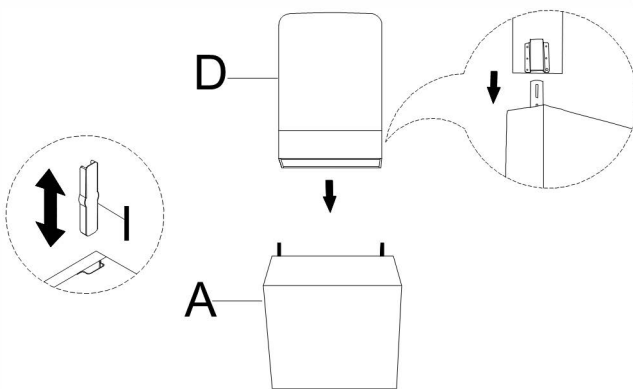

STEP 2:

Attach Left Backrest (B) and Right Backrest(C) to the Seat Body(A).

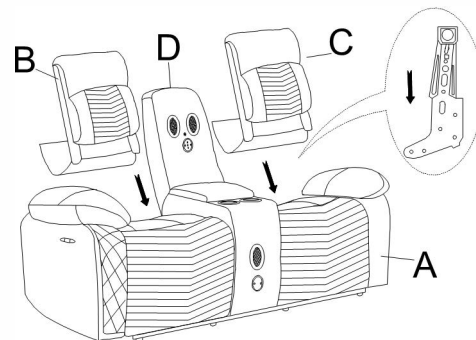

STEP 3:

Attach the Left EAR(E) and Right EAR(F) to the Backrest(B) and Backrest(C)

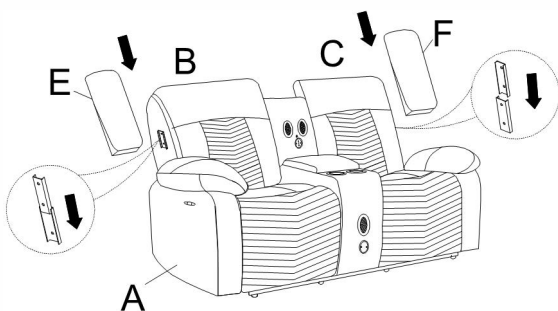

STEP 4:

Connect the power cord

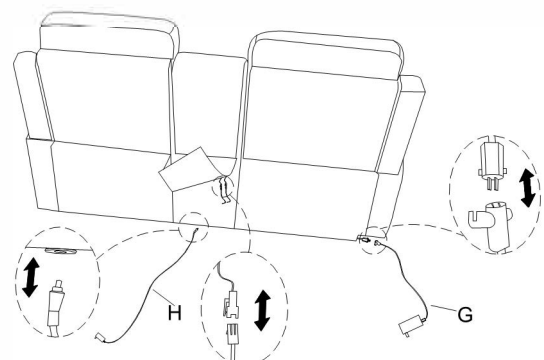

ASSEMBLY INSTRUCTION

Power Double Reclining Love Seat with Center Console, Wireless Speakers, LED and Charging Ports

STEP 5:

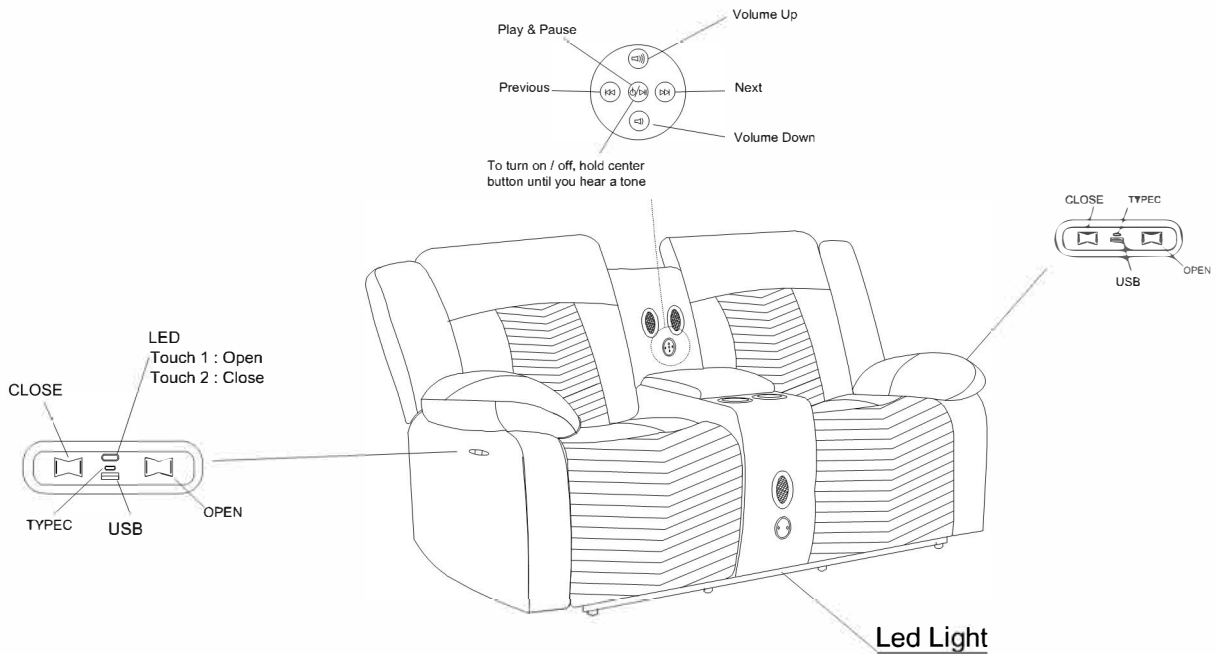

STEP 6:

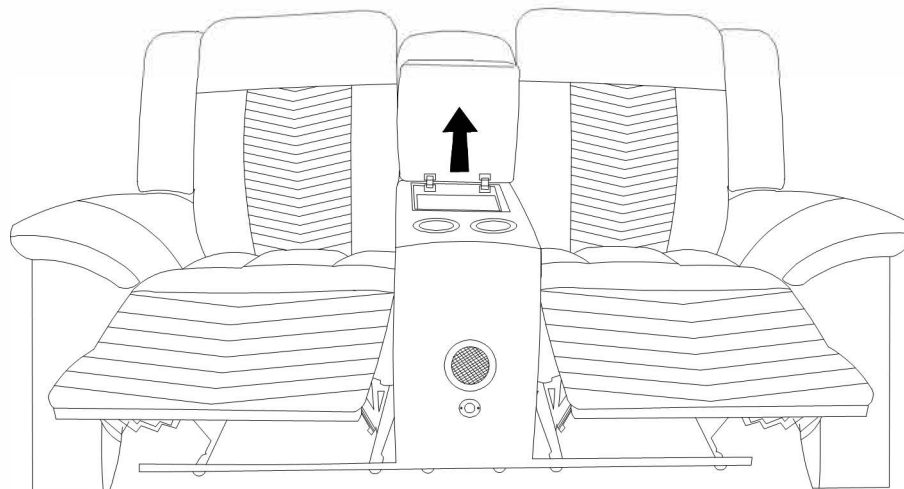



ASSEMBLY INSTRUCTION

Power Double Reclining Love Seat with Center Console, Wireless Speakers, LED and Charging Ports

STEP 7:
Completed

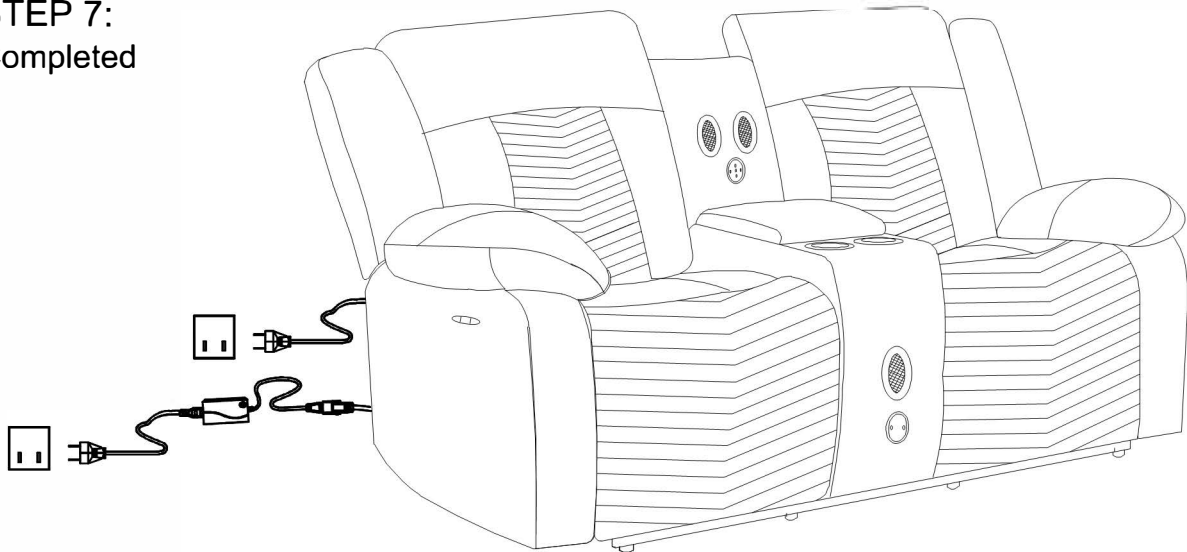

Care instruction on for PU furniture:

In order to maintain the original appearance of your PU furniture, please follow below simple care procedures:

- Avoid exposing furniture directly to sunlight or heating or heating conditioning outlets. Sunlight and or exposure to heating and air conditioning outlets will fade/damage PU.
- Do not place your upholstered furniture too close to windows, radiators, or vents, and be sure to use windows, radiators, or vents.
- Vacuum or wipe with a cloth regularly to remove dust.



For items used on wooden floor, hard surfaces or carpets, it is recommended to install protective pads under all legs and supports to avoid/prevent from damages/scratches and discoloration.

Warning!

Do not allow electrical cord to be pinched between moving parts or between the frame and the floor. Do not place cord under carpet or in location where it could become worn.

To avoid damage, please use scissors to remove this tag