

3 pcs Wicker Rocker Conversation Set

- Thank you for purchasing product.
- We are committed to providing customers with quality products and a good purchasing experience.
- Need any help regarding purchase or customer service, please email us!
(will be responded within 24 working hours)

Attention for assembly









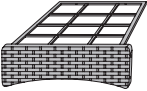

1. Read the instruction carefully and completely before assembling the product.
2. Follow the instructions step by step. Any wrong operation might damage the product, which will not be considered as quality defect of product itself. Any return caused by this reason will not be accepted.
3. Place product on soft floor (carpet, cardboard, wood) for assembly to prevent scratching or damage, never on concrete, sand or slate floor.
4. Verify all components and hardware are included according to the part list before start assembling. In case of missing of any part, stop assembling and contact us right away.
5. Electrical tools (not included) help assembly yet do not over drive the screws, bolts, nuts, etc.
6. Do not fasten screws, bolts, nuts tightly until the whole product is assembled completely in place. In case you have difficulty to put the parts together, try to loosen the fastened screws, bolts, nuts, which might solve the problem.
7. Follow the manpower request for assembly. Shortage of manpower might cause unsuccessful assembly or personal injury.
8. Do not use the product until all the components, screws, bolts, nuts are fastened tightly.
9. Contact us when you have any problem regarding assembly or any product issues, we will respond as soon as possible to help you out of problem. Don't return the goods on your purchase platform right away.

Maintenance

1. Always protect furniture with outdoor covers — you never know when a summer storm can hit! It's best to make sure the furniture is as dry as possible before putting covers on or storing long term, so residual moisture doesn't mildew. We suggest putting covers on whenever you go out of town and during the off-season, too.
2. Store cushions separately — preferably indoors — where they can stay dry. Be sure to remove cushions while cleaning your wicker.
3. Use a soft bristle brush to keep dust and dirt off your wicker furniture.
4. Clean the product with a damp cloth.
5. Don't power wash your wicker furniture — like abrasive cleaners, they can wear finishes and coloring down.
6. Check all components and bolts to be secured regularly.
7. Please note: the weight limit of rocker chair is 250 lbs max, table is 22 lbs max.

Limited Warranty: 1 year (12 months)

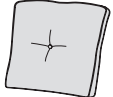
Part List

| No. | Description | Diagram | Qty (pcs) |
|-----|--------------|---|-----------|
| A | Chair Back |  | 2 |
| B | Seat Panel |  | 2 |
| C | Left Arm |  | 2 |
| D | Right Arm |  | 2 |
| E | Skid |  | 4 |
| F | Bolt 35mm |  | 20 |
| G | Washer |  | 20 |
| H | Screw |  | 8 |
| I | Seat Cushion |  | 2 |
| J | Back Cushion |  | 2 |
| K | Allen Wrench |  | 1 |

Rocker

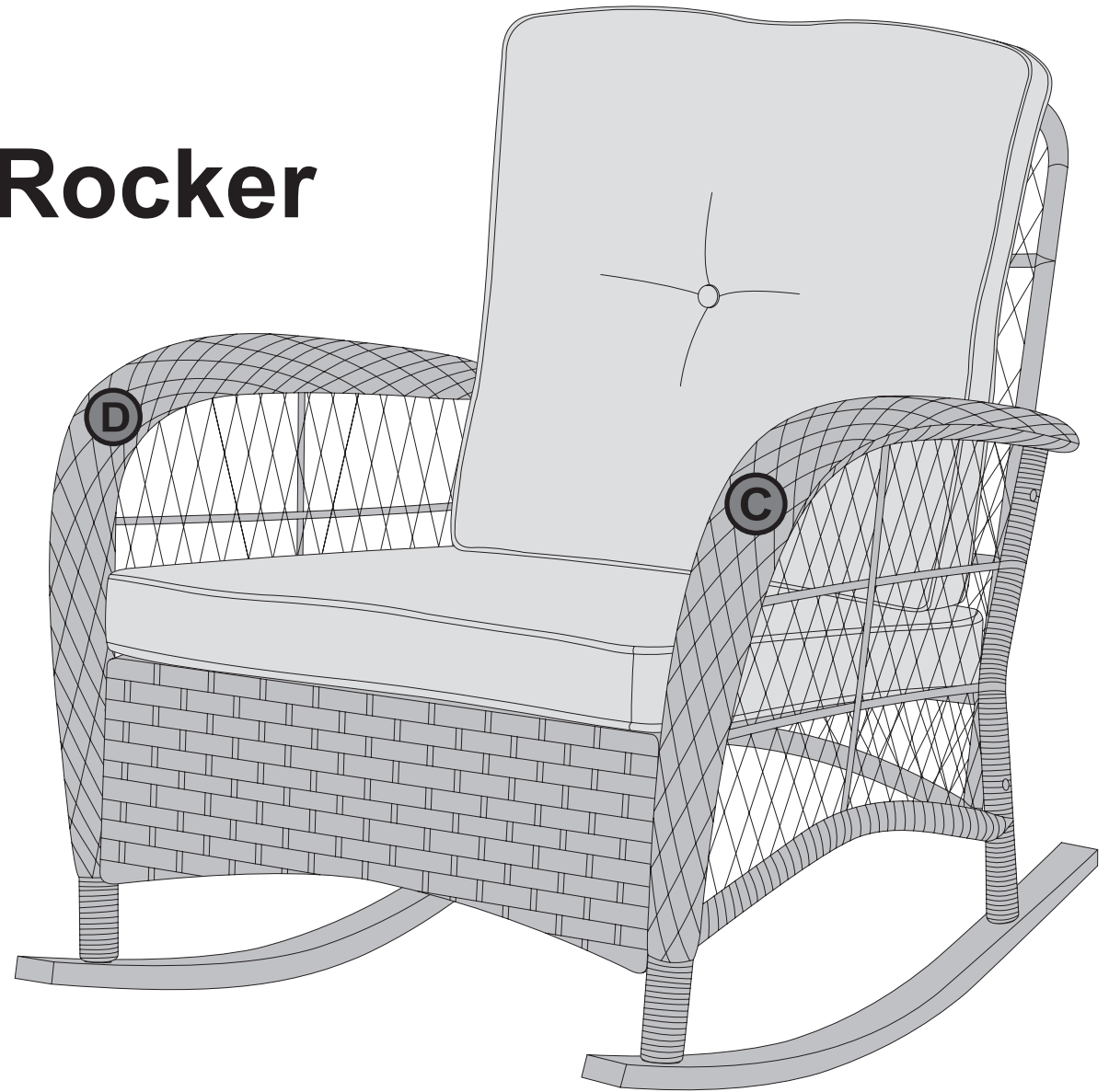

- ① People : 2
- ② Tool Required : Phillips Screwdriver
- ③ Estimated Time : 40 minutes
- ④ Don't fasten the bolts tightly until the whole product is assembled completely.

Step 1

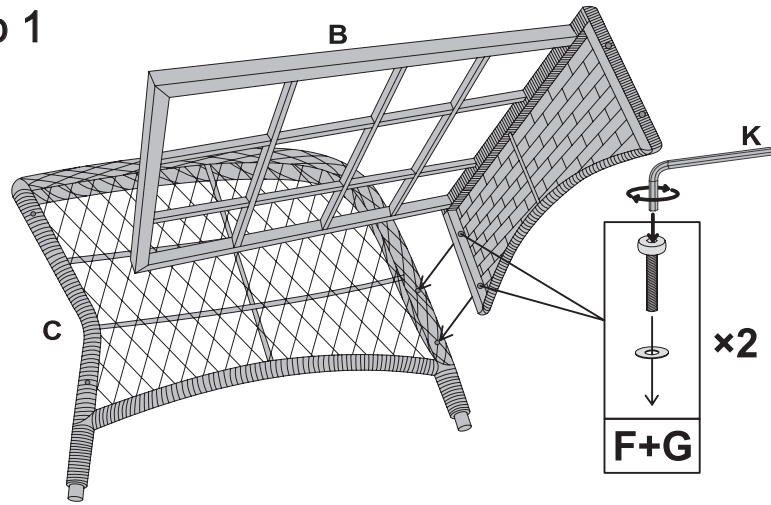

Place Left Arm(C) on the ground. Attach Seat Panel(B) and Left Arm(C) with 2 Bolts(F) & Washers(G) by Allen Wrench(K).

Step 2

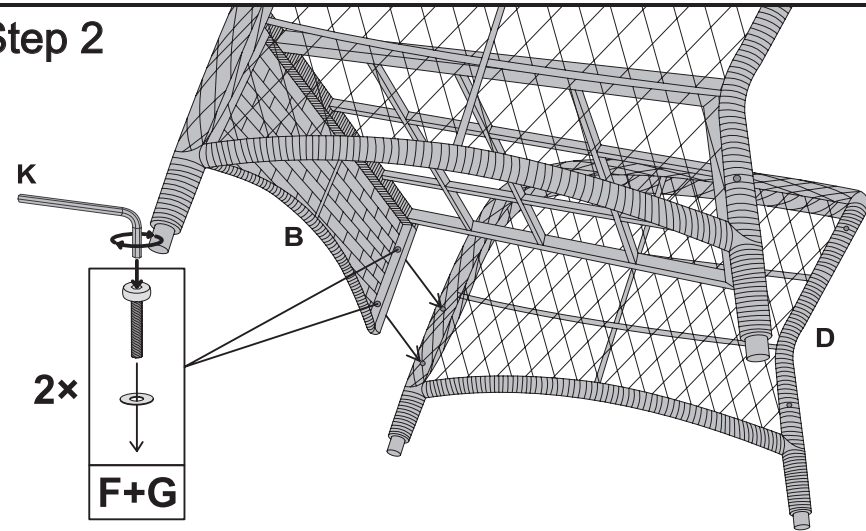

Place Right Arm(D) on the ground. Attach Seat Panel(B) and Right Arm(D) with 2 Bolts(F) & Washers(G) by Allen Wrench(K).

Step 3

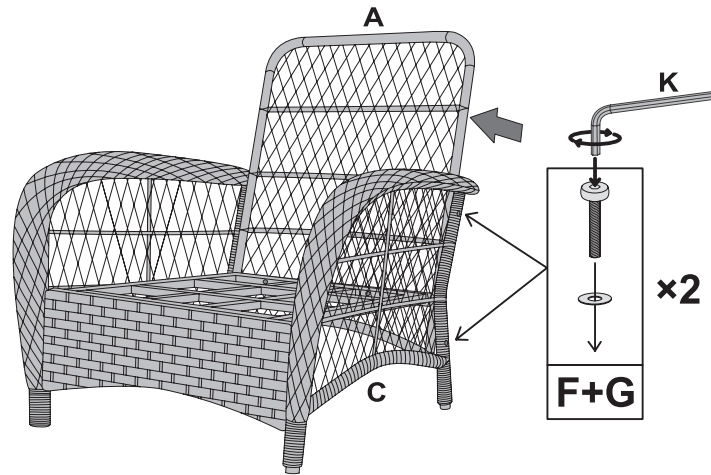

Attach Back Panel(A) and Left Arm(C) with 2 Bolts(F) & Washers(G) by Allen Wrench(K).

Step 4

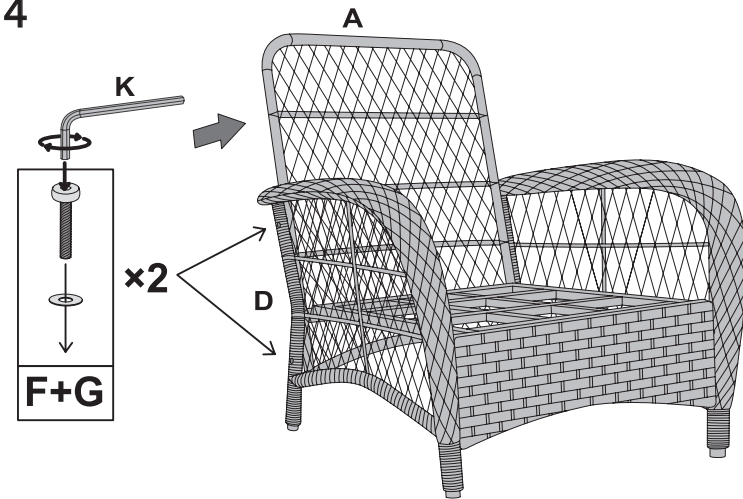

Attach Back Panel(A) and Right Arm(D) with 2 Bolts(F) & Washers(G) by Allen Wrench(K).

Step 5

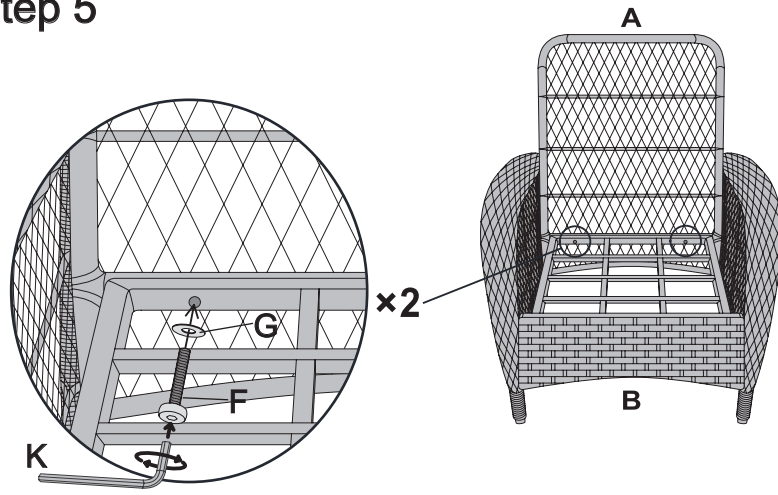

Attach Back Panel(A) and Seat Panel(B) with 2 Bolts(F) & Washers(G) by Allen Wrench(K).

Step 6

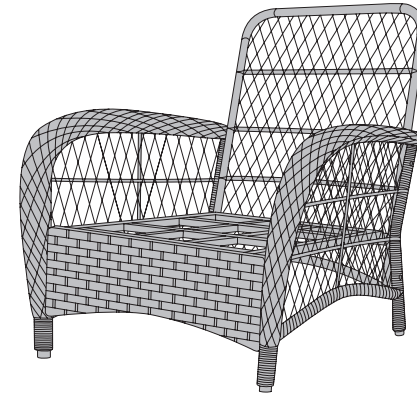

Check the chair frames are assembled in place. Then you can fasten all the bolts tightly.

Step 7

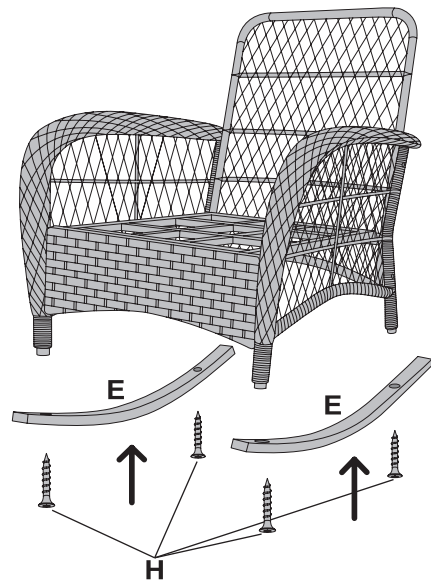

Attach Skids(E) to the chair with 4 Screws(H).

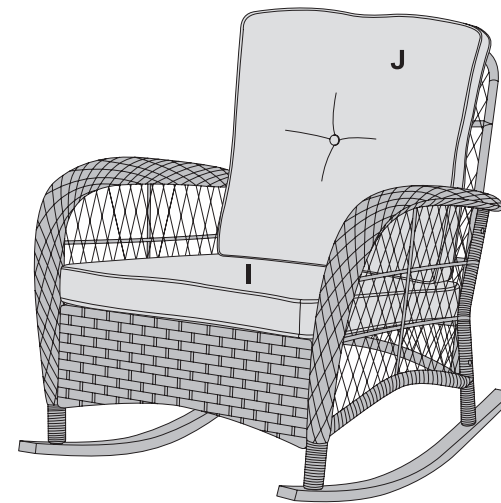

Step 8



Put the Seat Cushion(I) and Back Cushion(J) on the chair. Ready for use.

End Table

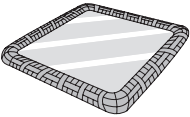
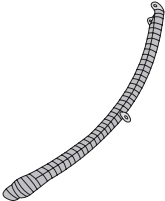
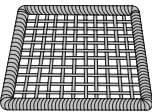
Part List

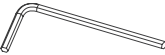
| No. | Description | Diagram | Qty (pcs) |
|-----|--------------|---|-----------|
| A | Table Top |  | 1 |
| B | Leg |  | 4 |
| C | Bottom Shelf |  | 1 |
| D | Bolt |  12mm | 12 |
| E | Washer |  | 12 |
| F | Allen Wrench |  | 1 |

1
Attach 4 Legs(B) and Table Top(A) with Bolts(D) & Washers(E) by Allen Wrench(F).

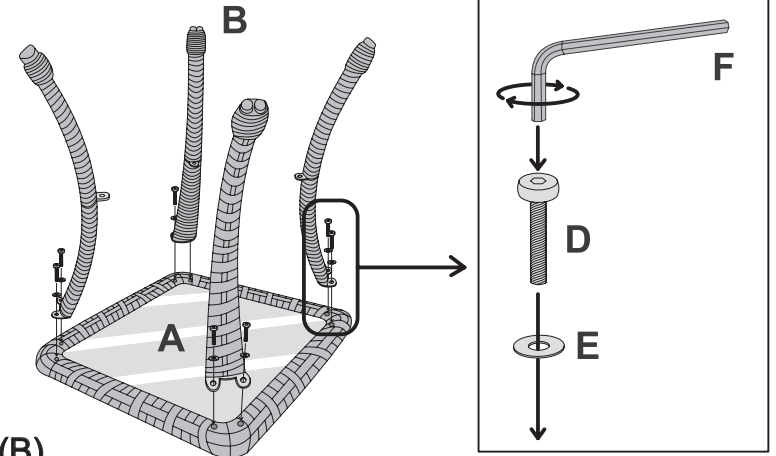

2
Attach Bottom Shelf(C) and 4 Legs(B) with Bolts(D) & Washers(E) by Allen Wrench(F).

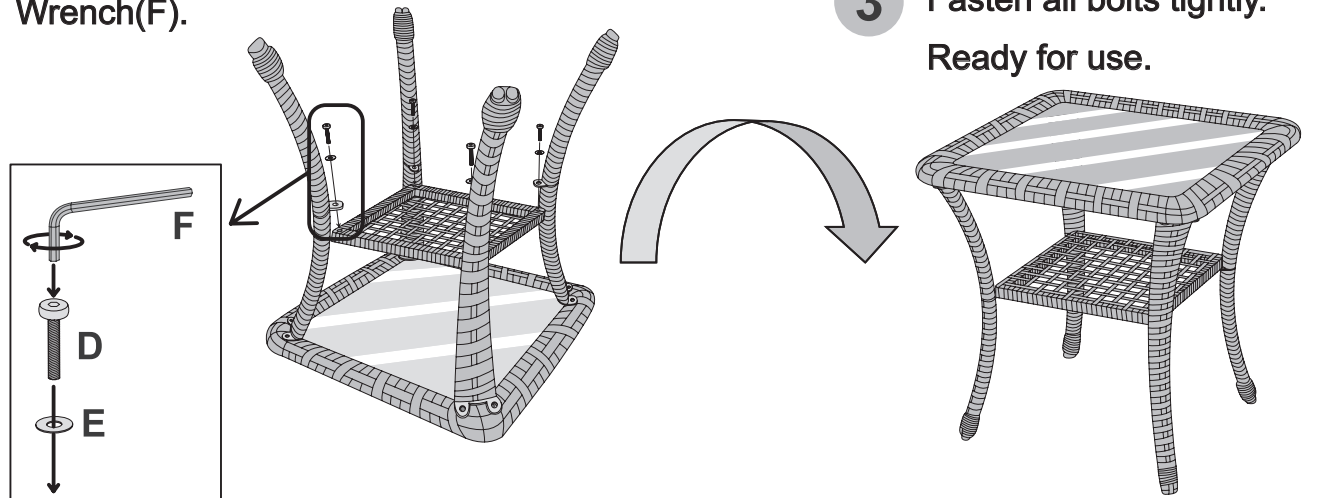

3 Fasten all bolts tightly. Ready for use.

