

Shoe Rack

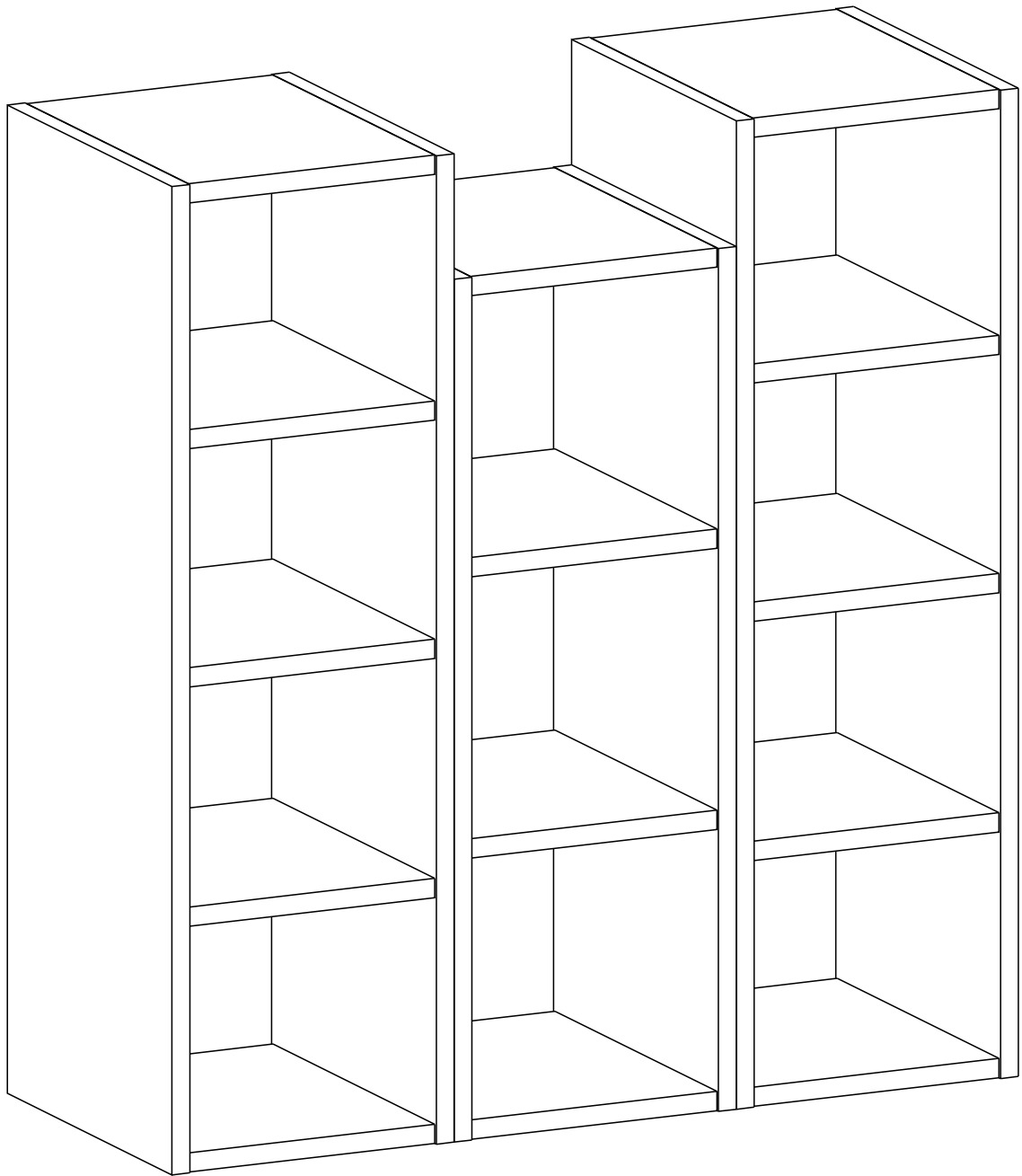

Dear Customer,

We design and produce our products for people to love and have fun with them as we do.

The product you bought was subjected to all sorts of tests and control before sending out to you.

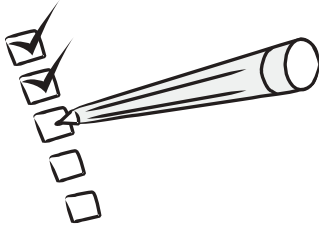

Before start assembling, please check the whole components and accessories according to the lists. If you bought more than one product, to prevent confusion be sure that you completed the first product. Then start the other product's assembling.

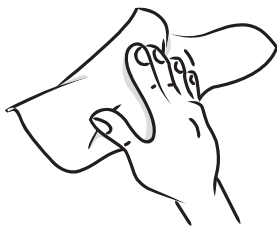

Before start assembling, please clean all the components with a damp cloth. Also for usual cleaning, this will be enough.



Although all the products are produced and packed carefully, sometimes happen that some component is damaged during the transportation. In such a case please check the missing or damaged part and do not hesitate to contact us.

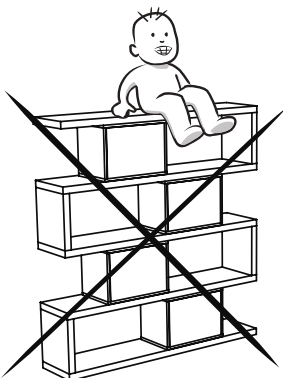



Do not use your furniture for out of purposes. If you would like to use it, please contact us for further questions.

Do not directly contact your furniture with excessive heat, cold and humidity because the product can be affected..

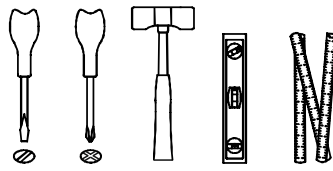
ACCESSORY LIST

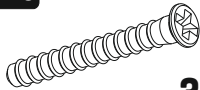
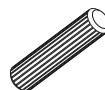

A13 KBN VDS  6x50 32x	A04 KVLV  24x	A06 18 mm  R1 32x
----------------------------------------------------------------------------------------------------------------------------	--------------------------------------------------------------------------------------------------------------------	------------------------------------------------------------------------------------------------------------------------

GENERAL VIEW

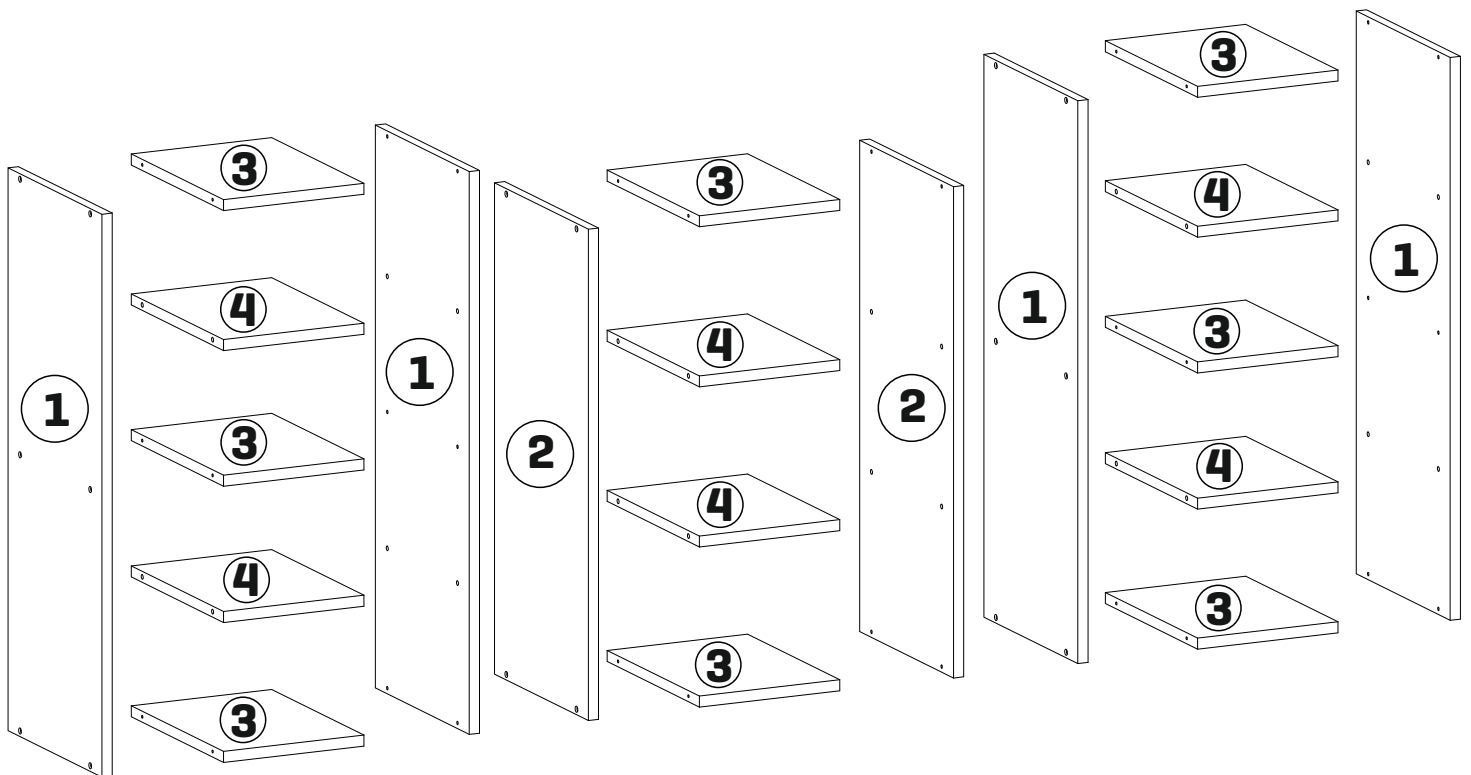

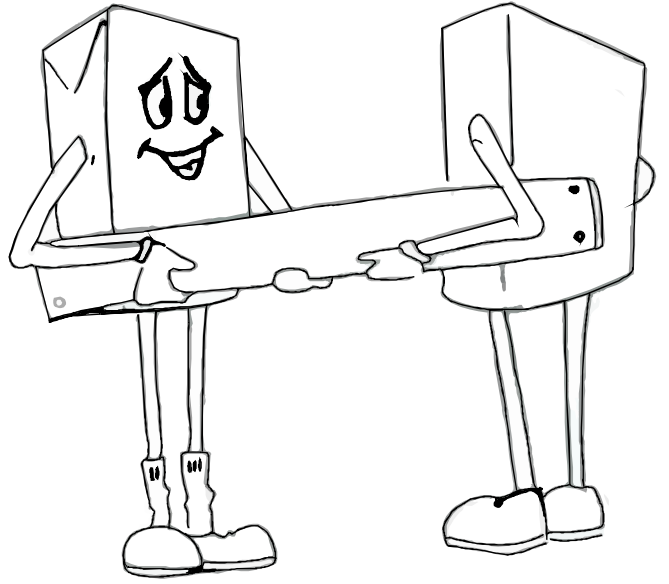
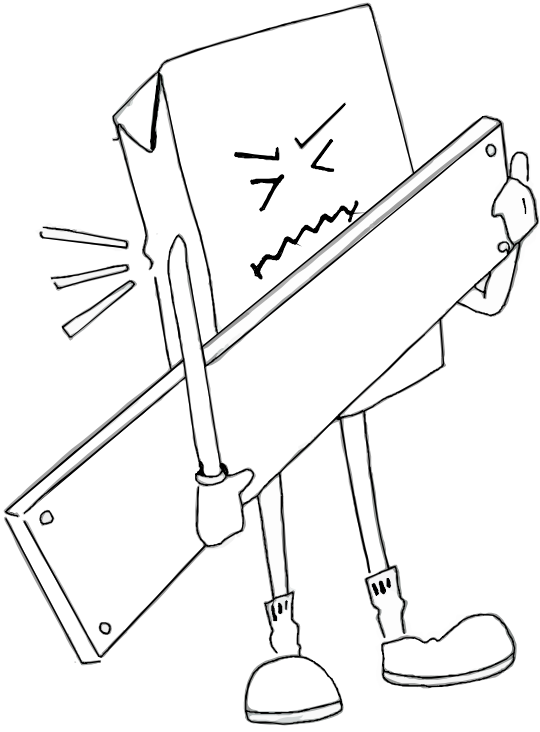

1

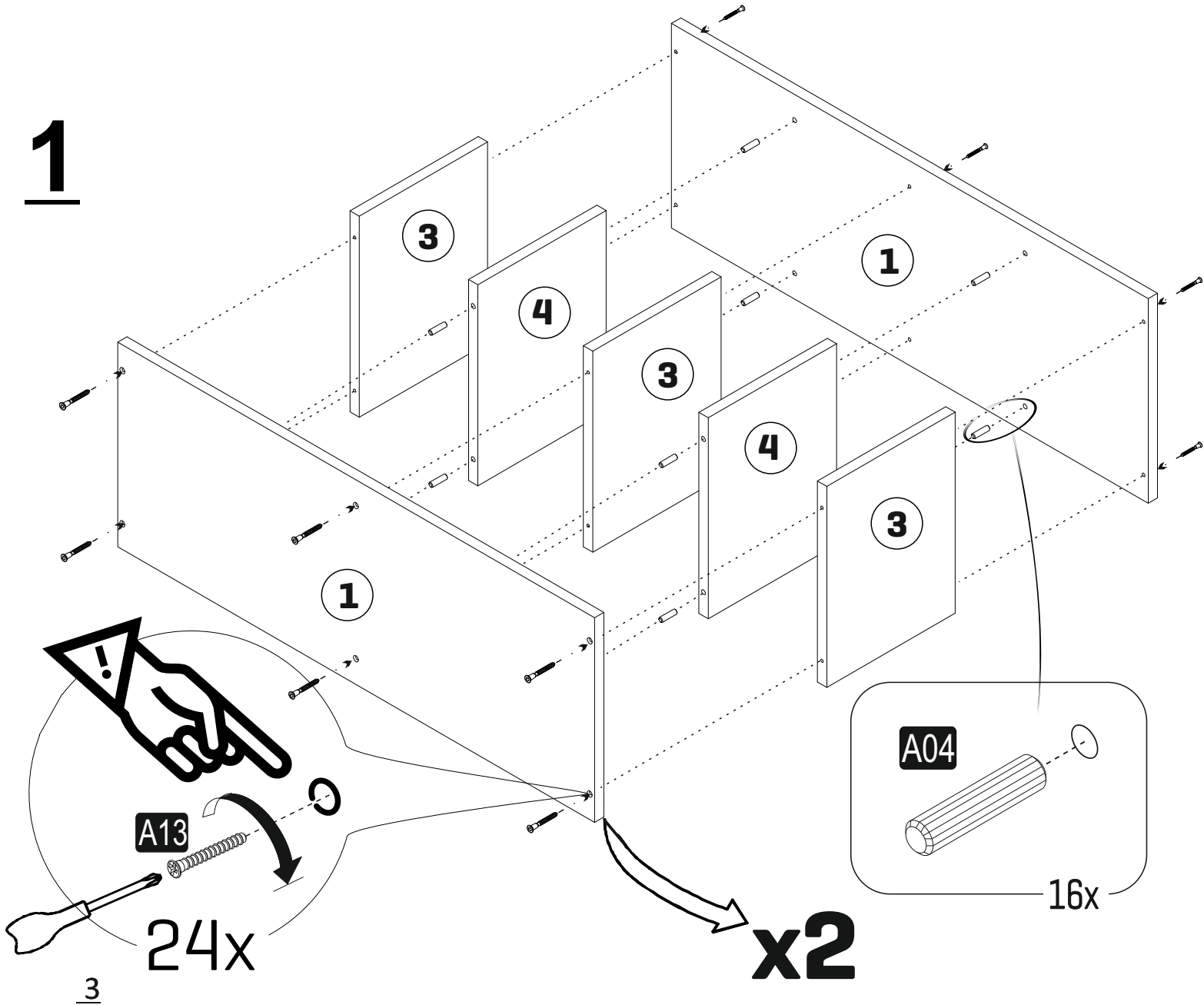

2

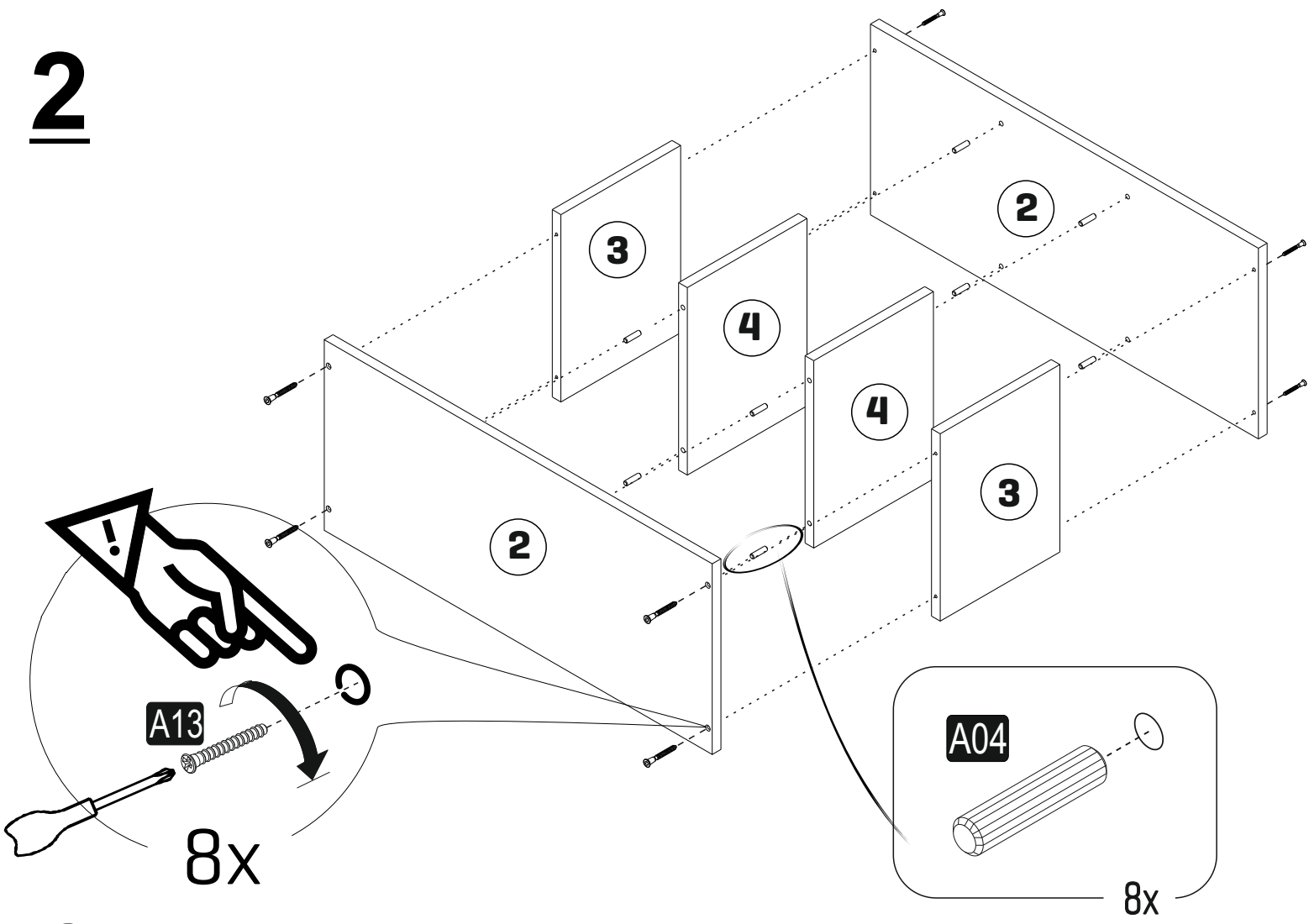

3

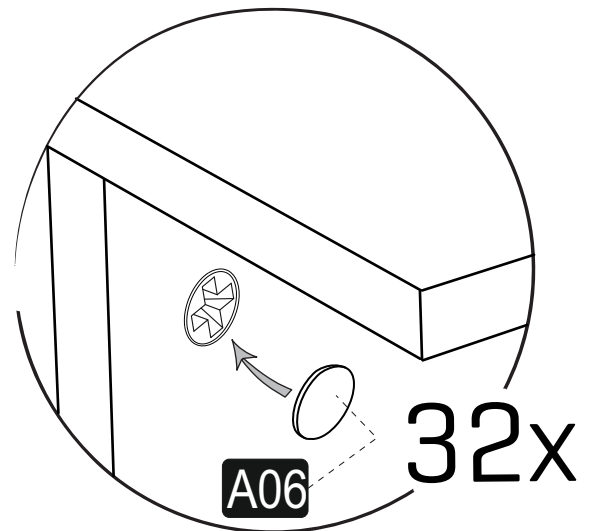
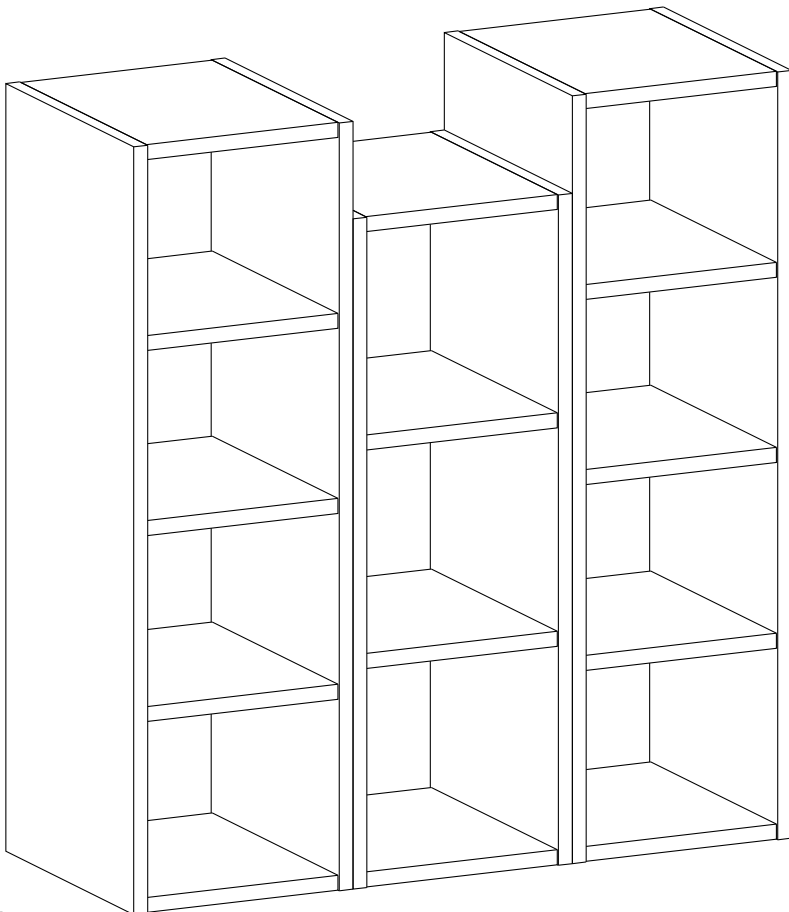

4



WARNING

CHOKING HAZARD

- This unit contains small parts which could be a choking hazard for small children. Children should be under adult supervision at all times.
- Do not overload the unit. Each shelf has a recommended capacity of 13 pounds, and the total weight on the unit should not exceed 39 pounds for wall shelves.
- Do not climb, step, or stand on the unit.
- Do not mount or attach items to the front, rear, or sides of the unit. This can cause the unit to become unbalanced and fall.
- Do not stack units.
- All units must be secured individually to wall studs using hardware provided. If wall studs are not accessible, consult your local hardware store for appropriate mounting hardware.
- We recommend you hand-tighten screws. Use care not to overtighten if using power tools. Follow proper safety procedures if using power tools and/or ladders.
- We recommend you protect your work surface during assembly to prevent scratching or damage to tabletops, wood floors, etc.
- Failure to follow the instructions listed here could result in bodily injury or damage to personal belongings. Use caution and follow safety procedures.