

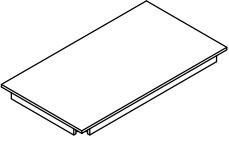



# Assembly Instructions

ITEM NO: 11027

Thank you for purchasing this quality product. Be sure to check all packing material carefully for small parts that may have come loose inside the carton during shipment. (Note: Loosely thread all screws/bolts first. Once the item is assembled then completely tighten.)

PARTS LIST:				HARDWARE LIST:				
No.	Description	Sketch	Quality	No.	Sketch	Description	Size	Quality
1	Table Top		1 Pc	A		Allen Head Bolt	Ø8 x 50mm	12 Pcs
				B		Lock Washer	Ø9 x Ø13mm	12 Pcs
2	Shelf		1 Pc	C		Flat Washer	Ø8 x Ø20mm	12 Pcs
				D		Allen Key	4 x 110mm	1 Pc
3	Leg		4 Pcs					

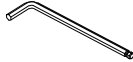
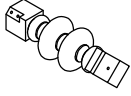
## STEP 1

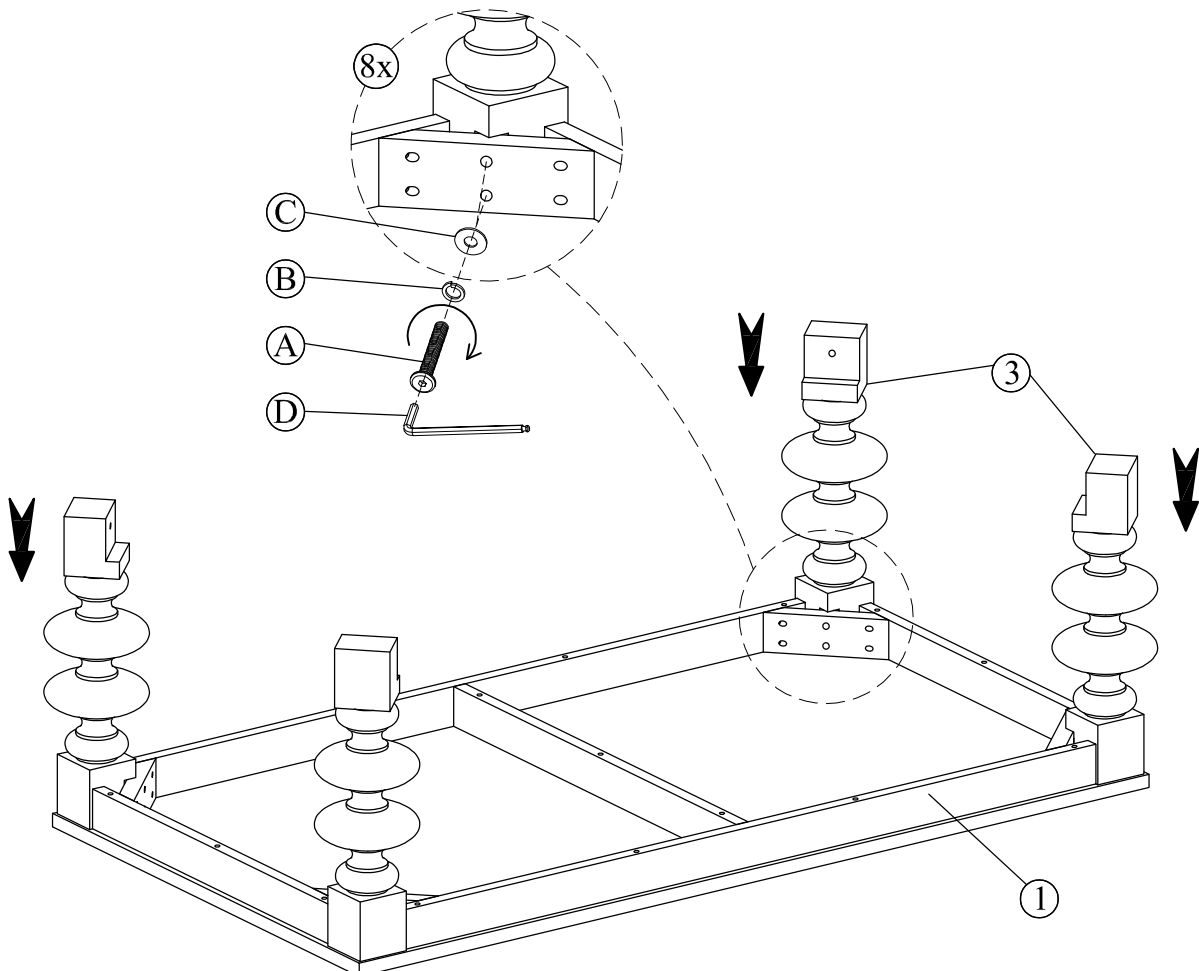

# Assembly Instructions

ITEM NO: 11027

## STEP 2

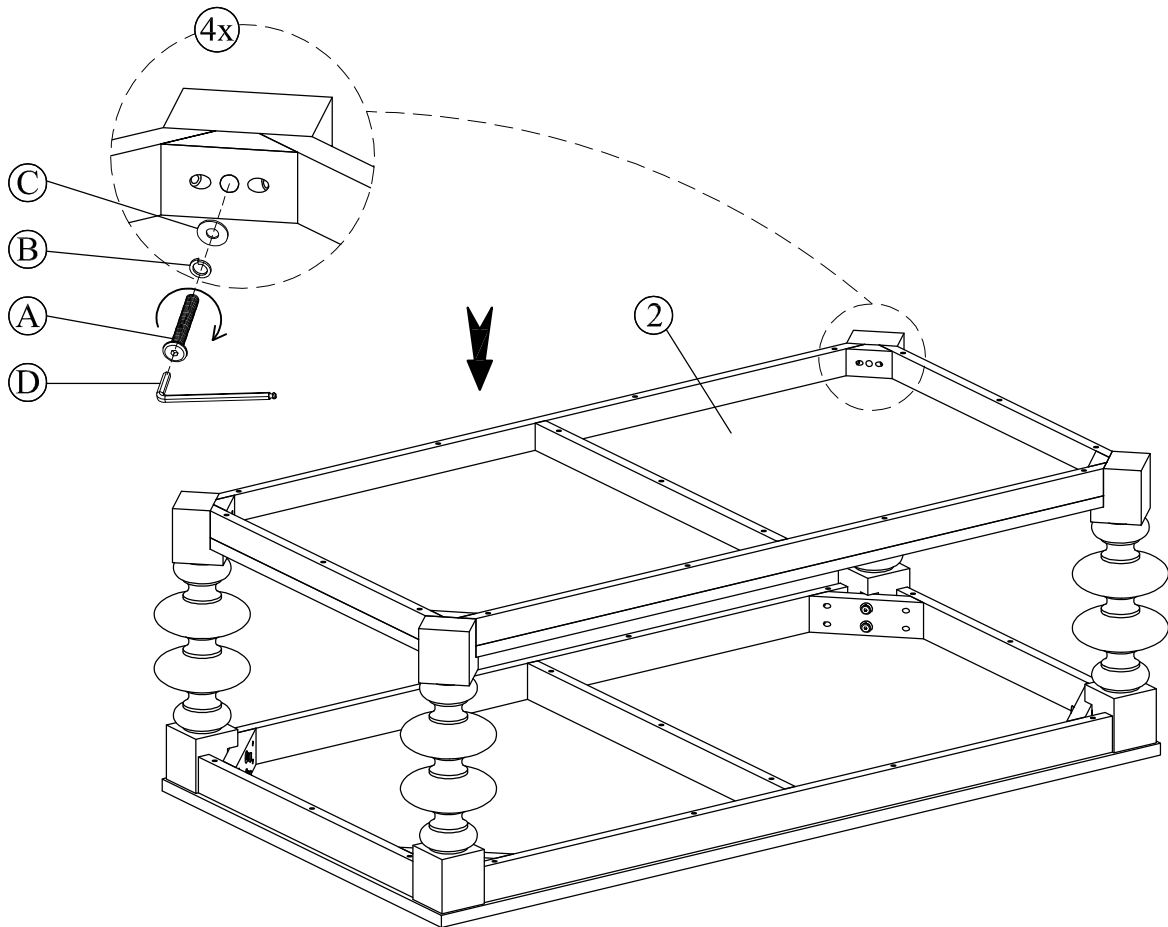

## STEP 3

