

# Assembly Instructions





## DRESSER MIRROR

Thank you for purchasing this quality product. Be sure to check all packing material carefully for small parts, which may have come loose inside the carton during shipment. Identify, count all parts and compare with the **HARDWARE LIST** below.

Caution: Please read the instructions thoroughly before assembly.

1. We recommend that you assemble this product with the assistance of another person; this will make the assembly easier, and will help eliminate damage to the product or injury to persons during assembly.
2. Please do not over tighten screws or bolts until the assembly is completed.
3. Please put all parts on a non-abrasive floor before assembly, and follow the assembly steps to assemble your newly purchased product correctly and efficiently.

### PART LIST

NO:	SKETCH	DESCRIPTION	Q'TY
A		Dresser	1 Pc
B		Support With Leveler	1 Pc
C		K.D. Foot	4 Pcs
D		Anti-tip restraint	1 Set

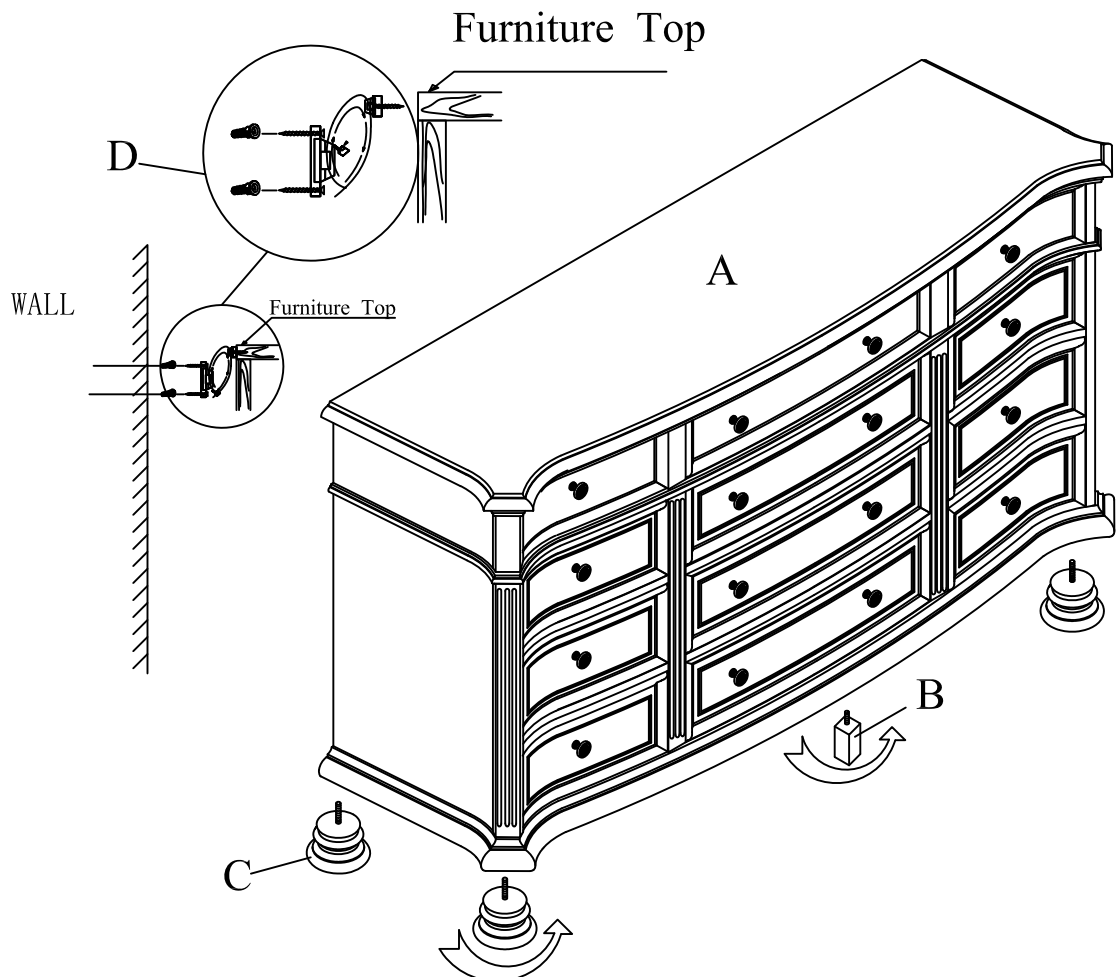

Note: Tipping hardware are attached to back panel







# Assembly Instructions

## DRESSER MIRROR

### PART LIST

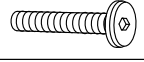
NO:	SKETCH	DESCRIPTION	Q'TY
A		Dresser	1 Pc
B		Mirror	1 Pc
C		Mirror Support	2 Pcs

### HARDWARE LIST

NO:	SKETCH	DESCRIPTION	Q'TY
1		JCBC Bolt 1/4" * 38mm	8 Pcs
2		Spring Washer 1/4" * 11mm	8 Pcs
3		Flat Washer 1/4" * 19mm	8 Pcs
4		Allen Key	1 Pc

