

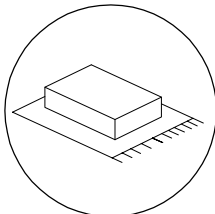

		30'
 		
		1

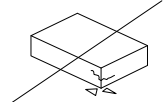

A

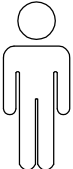
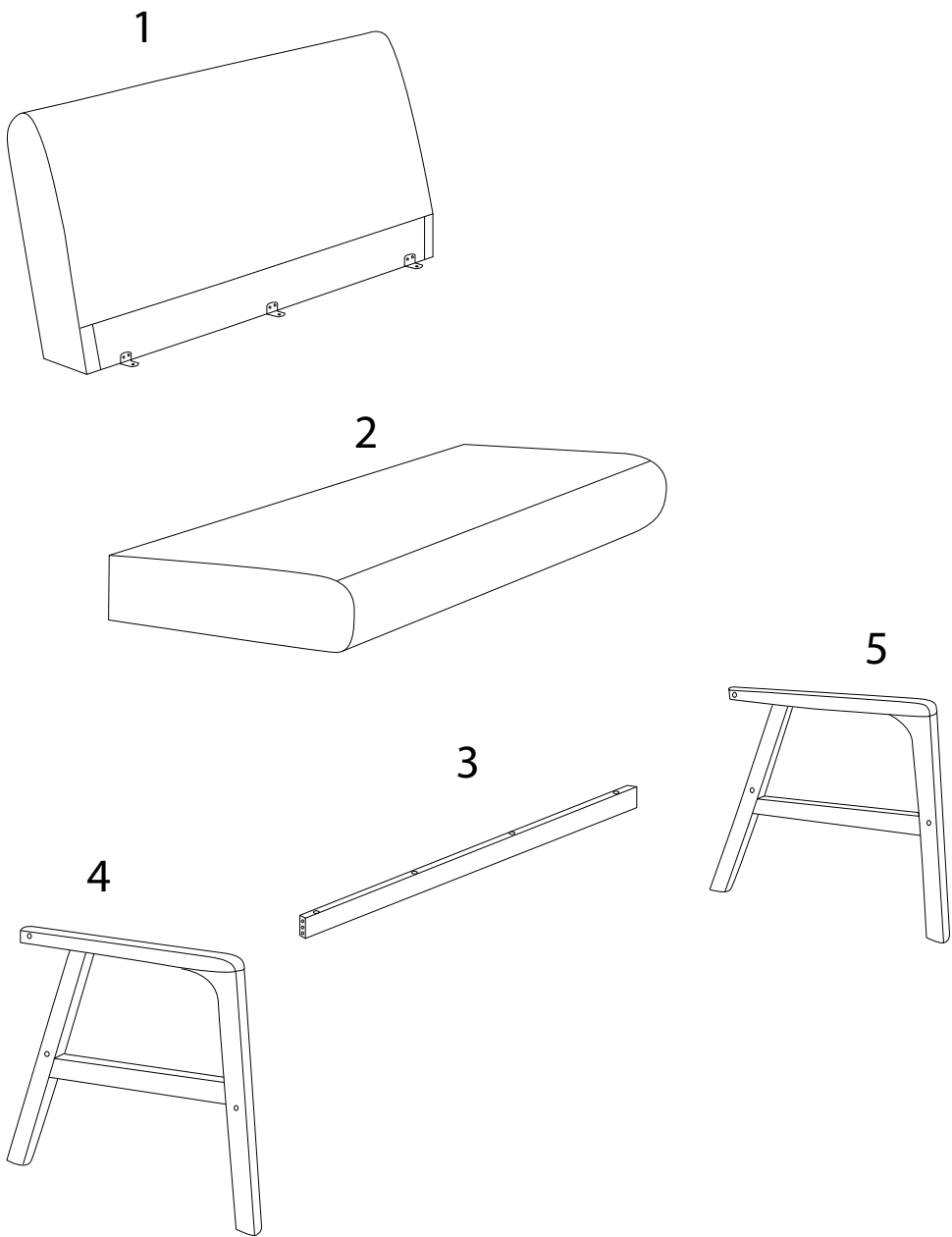
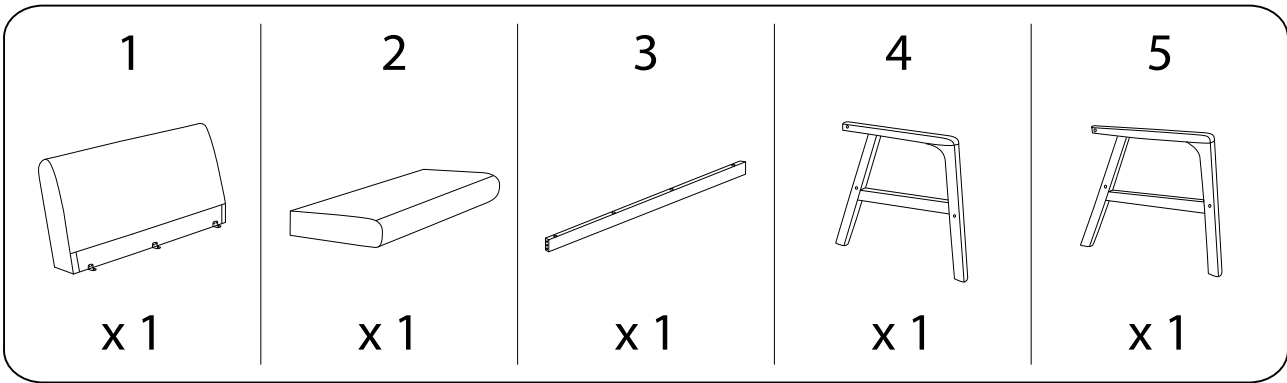
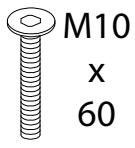

x 6

B

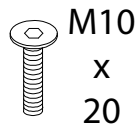

x 3

C

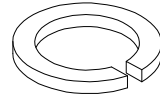

x 6

D

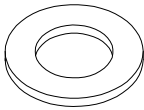

x 6

E



x 2

F



x 4

G

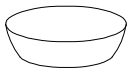

x 6

H

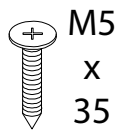

x 4

I

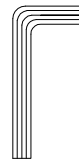

x 1

1

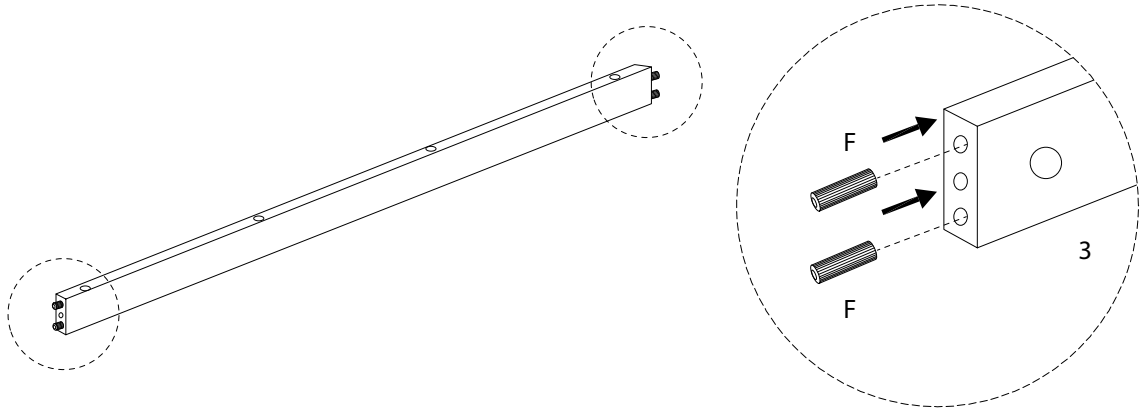
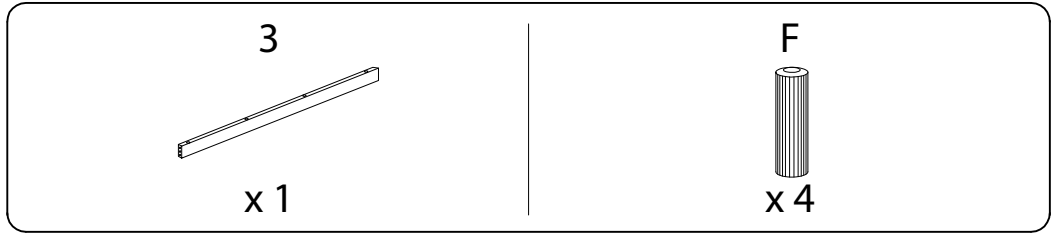

2

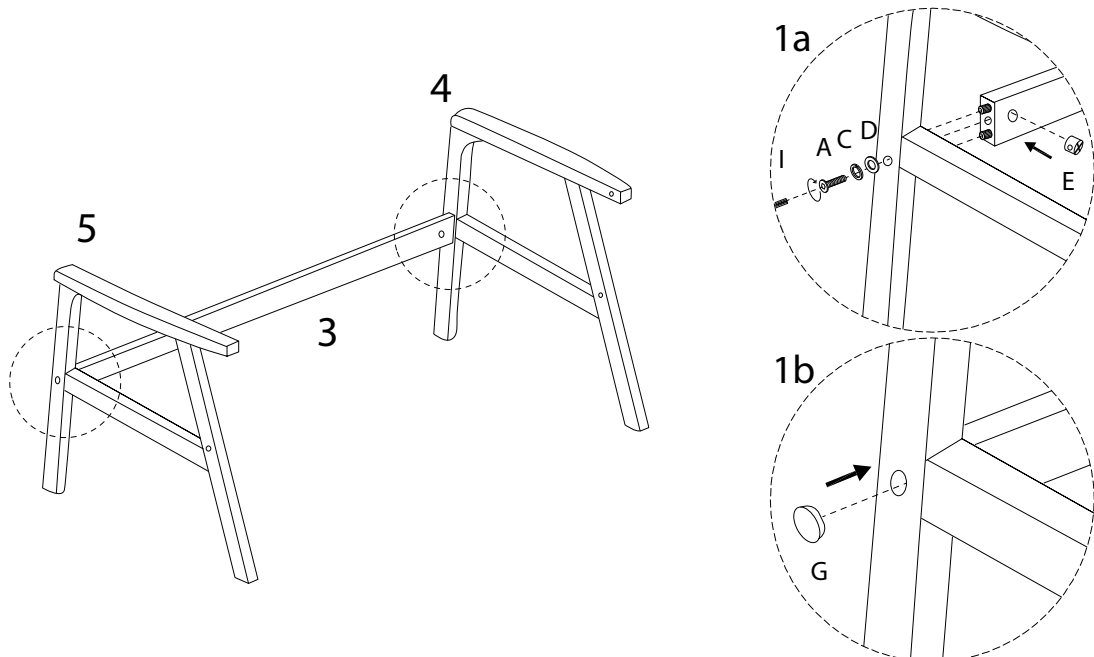
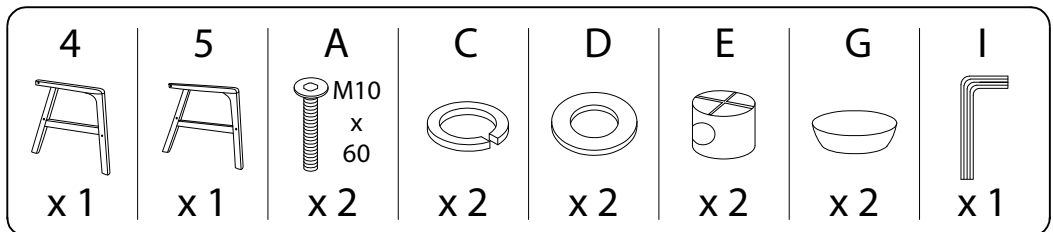

3

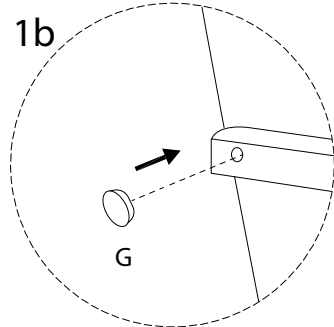
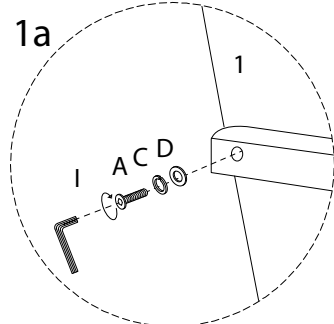
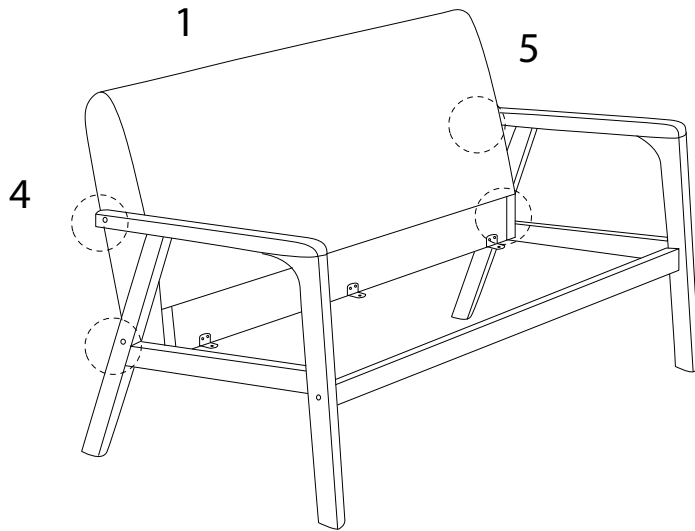
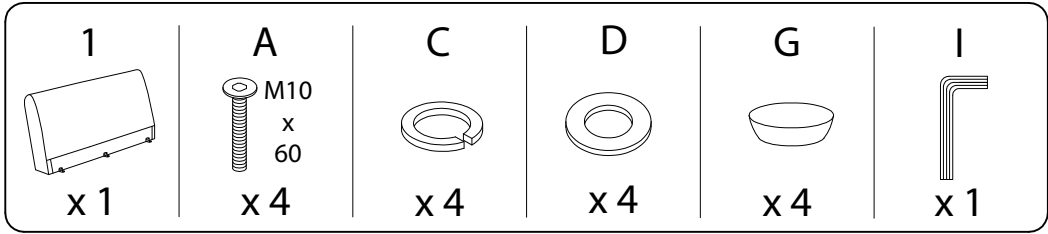

4

