

INSTRUCTION MANUAL

Arched Pergola

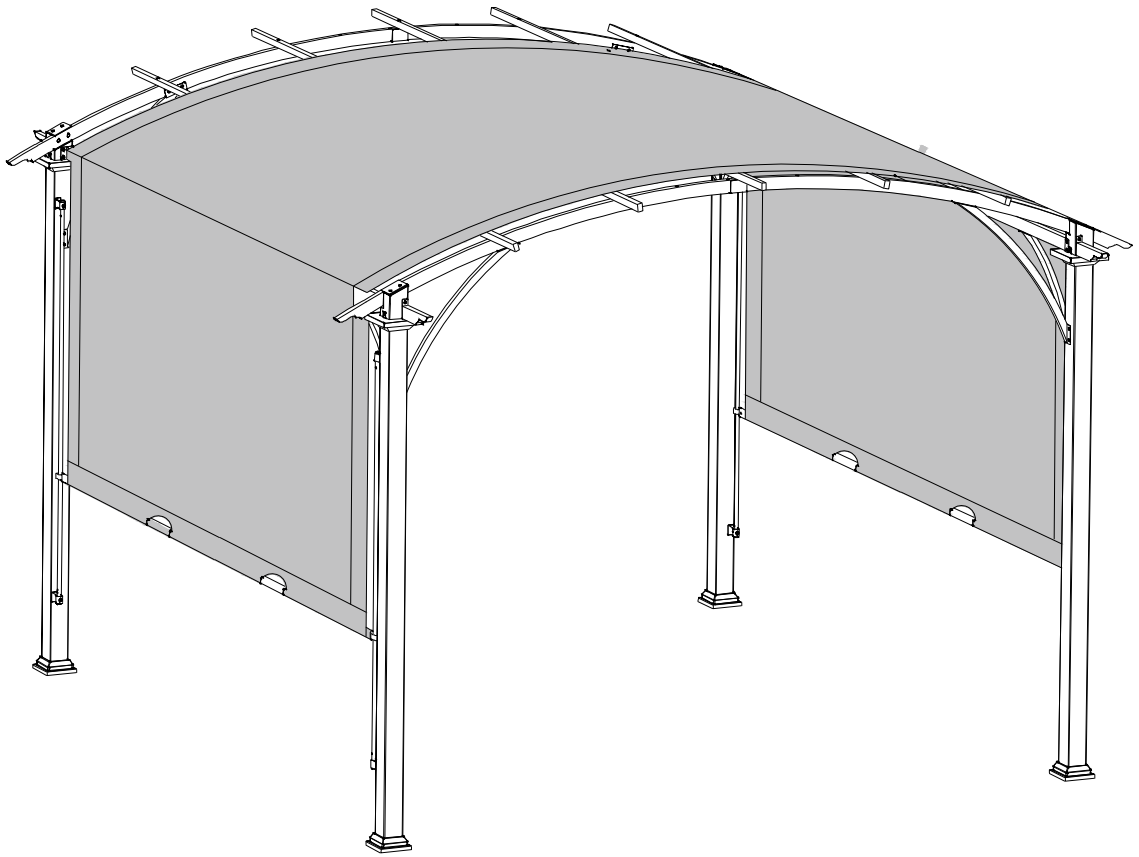

WARNING:



To reduce the risk of serious injury, read the following safety instructions thoroughly before assembling and using the gazebo.

- Check with your local governing authority/local municipal codes regarding installation and permitting of such structures before assembly.
- Use of personal protective equipment including gloves, safety glasses, and closed toe footwear is recommended during assembly.
- Requires two or more people to assemble and install safely and correctly.
- The product is required to be installed on level solid surface and is not intended for unsecured use. The gazebo is to be anchored to the surface with appropriate bolts or anchors. These anchors need to be purchased separately for the specific installation surface. Do not assemble the gazebo on soil, earth, or bare ground.
- Ensure enough clearance around the product. Before assembling the product, find level ground no less than 6' (1.8 m) away from any structures or obstructions, such as fences, buildings, or overhead obstacles.
- Do not assemble or install the gazebo underneath electrical lines or above underground utilities.
- Check for underground utilities before digging or driving stakes into the ground.
- This gazebo is not to be regarded as part of a building/house structure.
- All assembly and maintenance of the product must be carried out by adults only.
- Use all power tools and hand tools in accordance with their respective safety manuals.
- Keep children and pets away while setting up the gazebo.
- Do not hang heavy weights from the roof frame.
- Do not climb onto the roof of the gazebo for any reason.
- Check all nuts and bolts monthly to ensure bolts/nuts are tightened.
- Check the metal hardware monthly to ensure there are no exposed sharp edges or rust. Sand sharp edges or rust with sandpaper and apply touch up paint. Always use lead free paint that conforms to 16 CRF Part 1303.

Needed for assembly: *(The following tools are not included)*

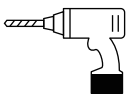

Pistol Drill

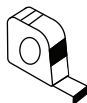

Tape Measure

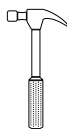

Hammer



Screwdriver



Level

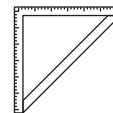

Framing Square















Ladder

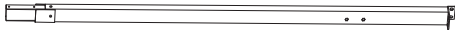

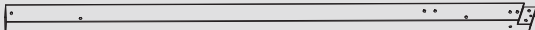
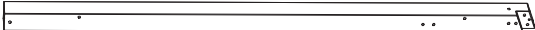









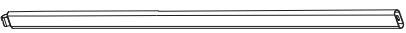

Two or more people

Part List

Label	Description	Sketch	QTY
A1	Roof Tube A1		5
A2	Roof Tube A2		5
B1	Roof Tube Curved B1		2
B2	Roof Tube Curved B2		2
B3	Connector B3		2
C1	Lintel C1		2
C2	Lintel C2		2
D	Decoration for Post		4
D4	Top Cover for Post		4
E	Post E		2
F	Post F		2
G	Base		4
H	Base Cover		4
I1	Corner Brace I1		2
I2	Corner Brace I2		2

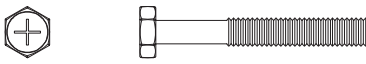
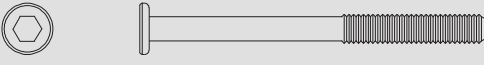
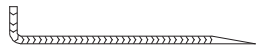
Part List

Label	Description	Sketch	QTY
J1	Corner Brace J1		2
J2	Corner Brace J2		2
L	Connector L		8
M	Weight Bar M		2
N	Weight Bar N		2
O	Guide Tube		4
P	Shade Fabric		1
AA	Bolt M6 x 15		88
BB	Bolt M6		124
CC	Bolt M6 x 15		18
DD	Bolt M6 x 45		18
EE	Bolt M6 x 70		8
FF	Stake Ø6 x 230		8
Z1	Wrench M6		2
Z2	Allen Key M6		1

Step 1

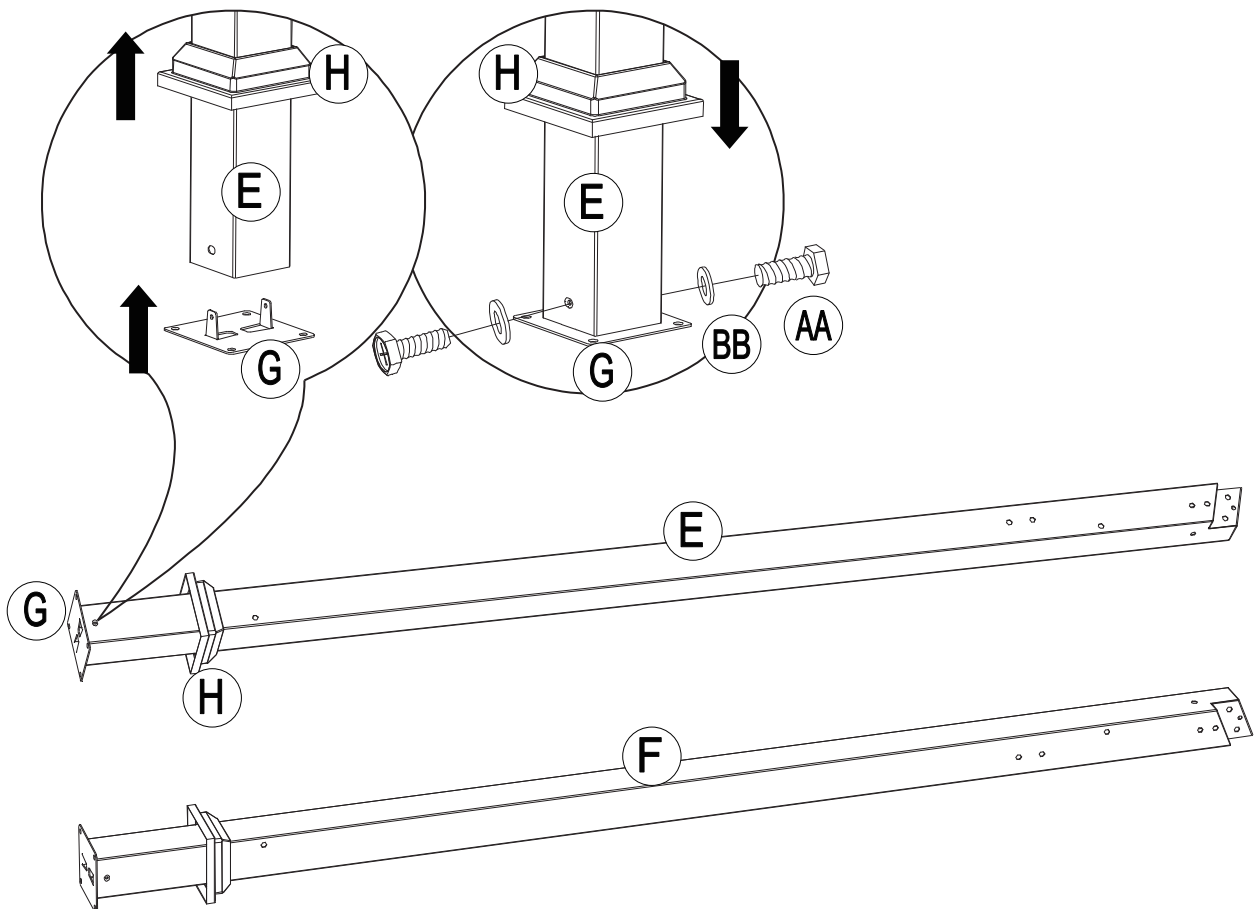
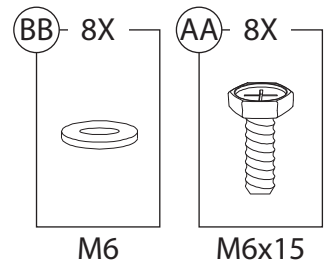
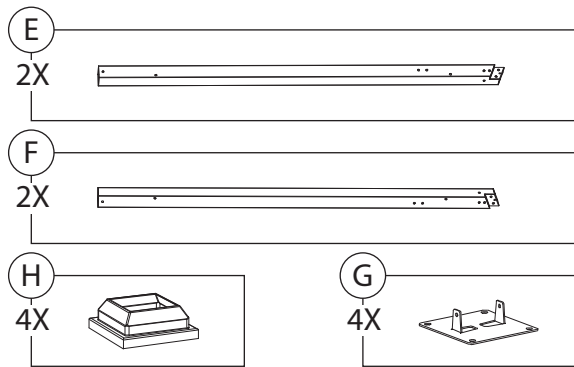

Step 2

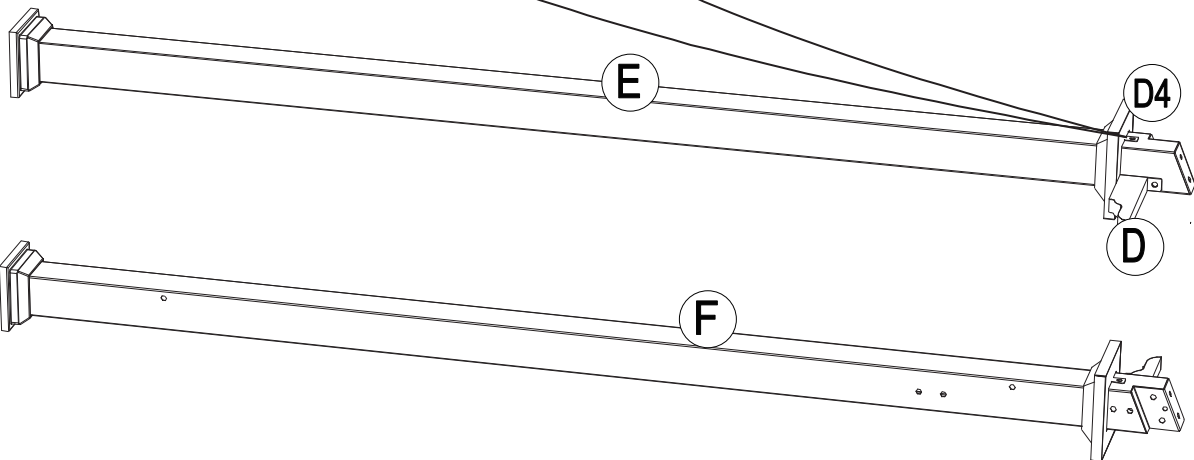
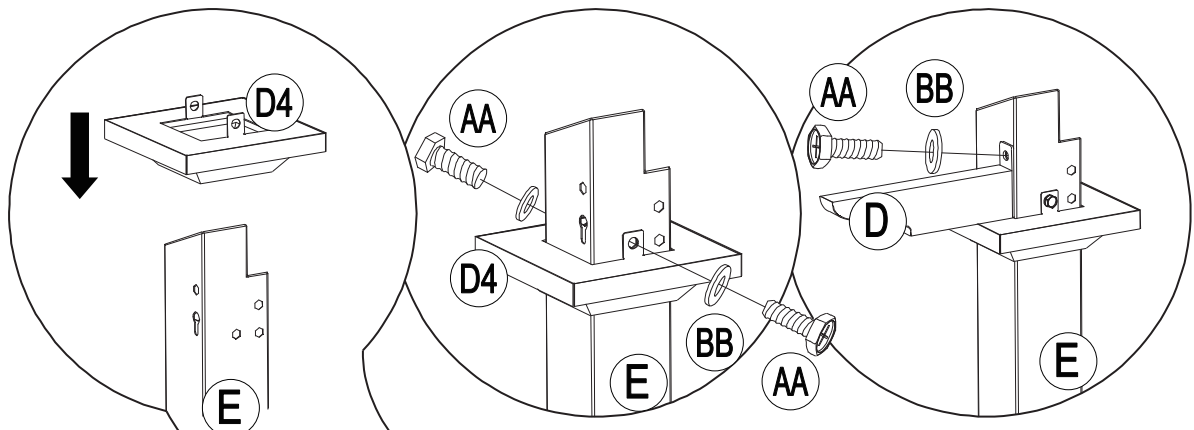
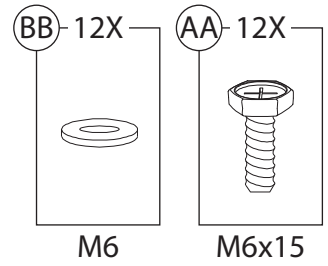
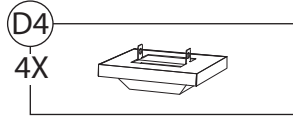
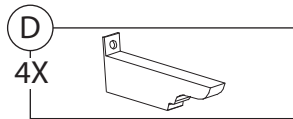

Step 3

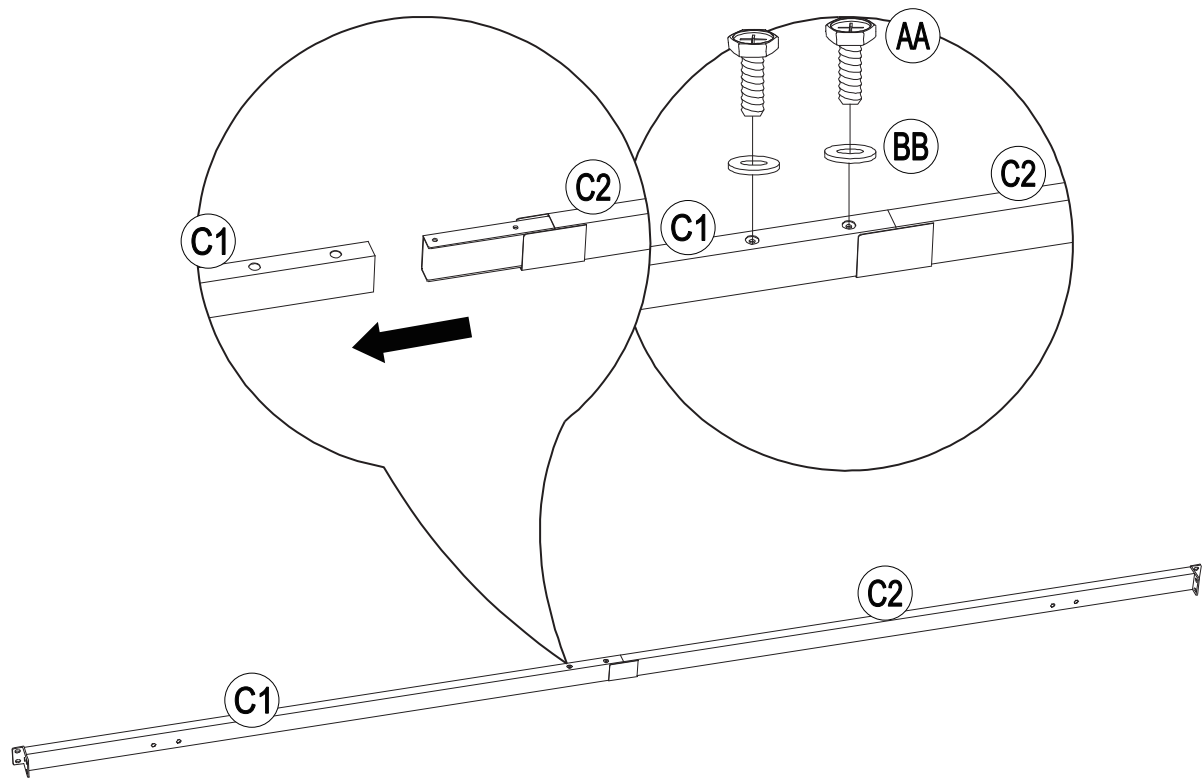
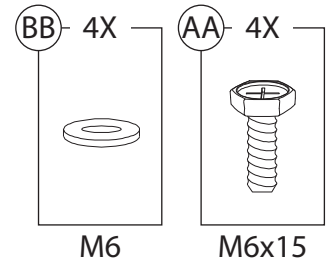
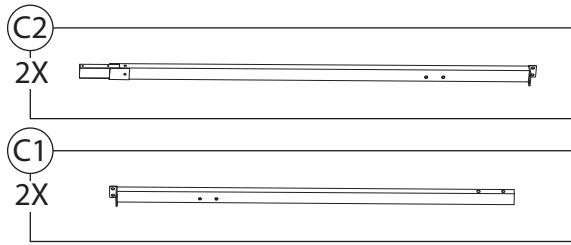

Step 4

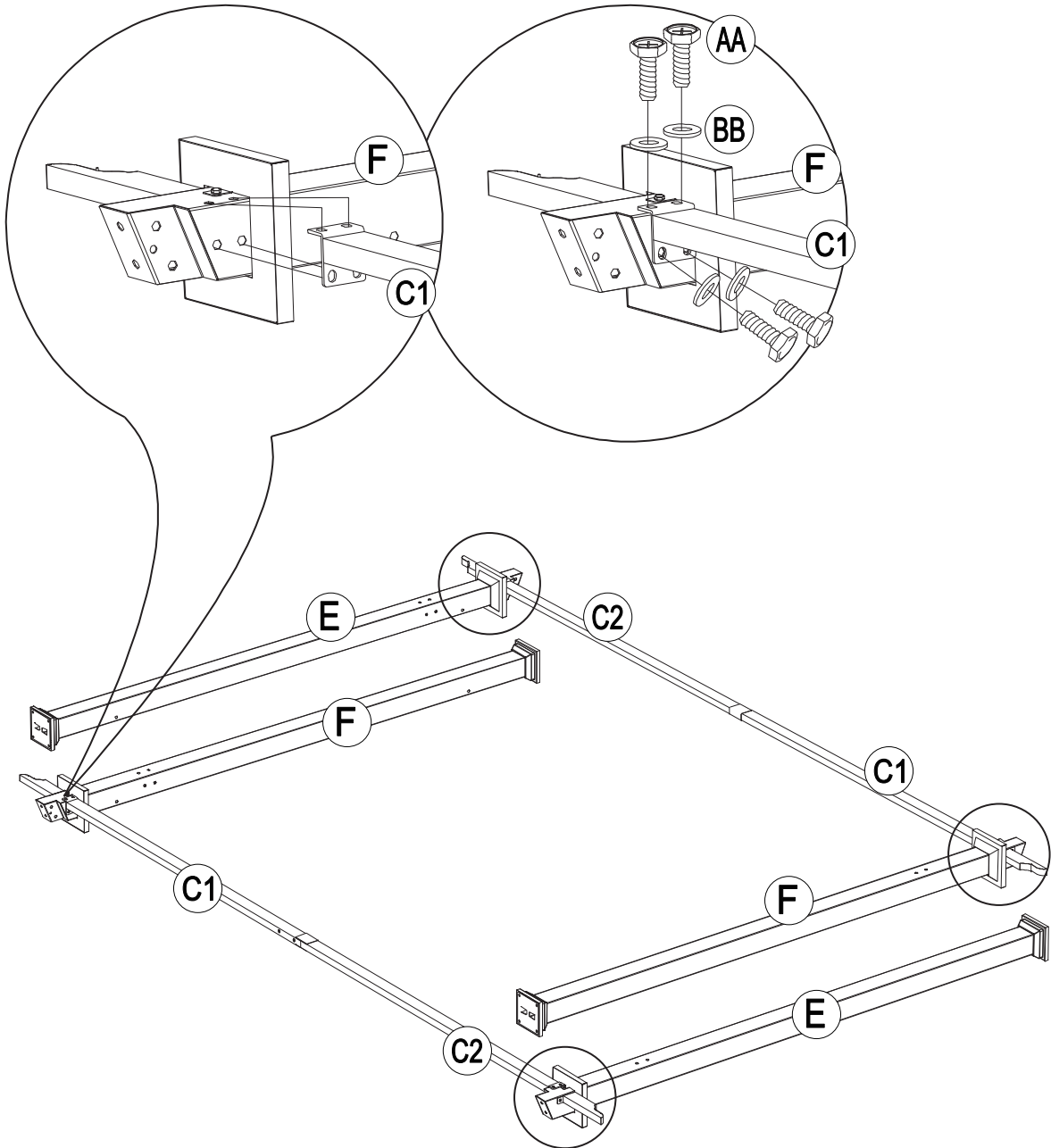
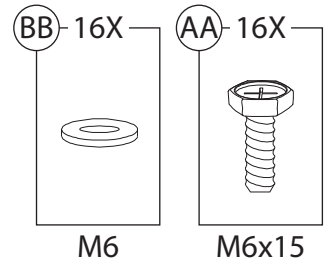

Step 5

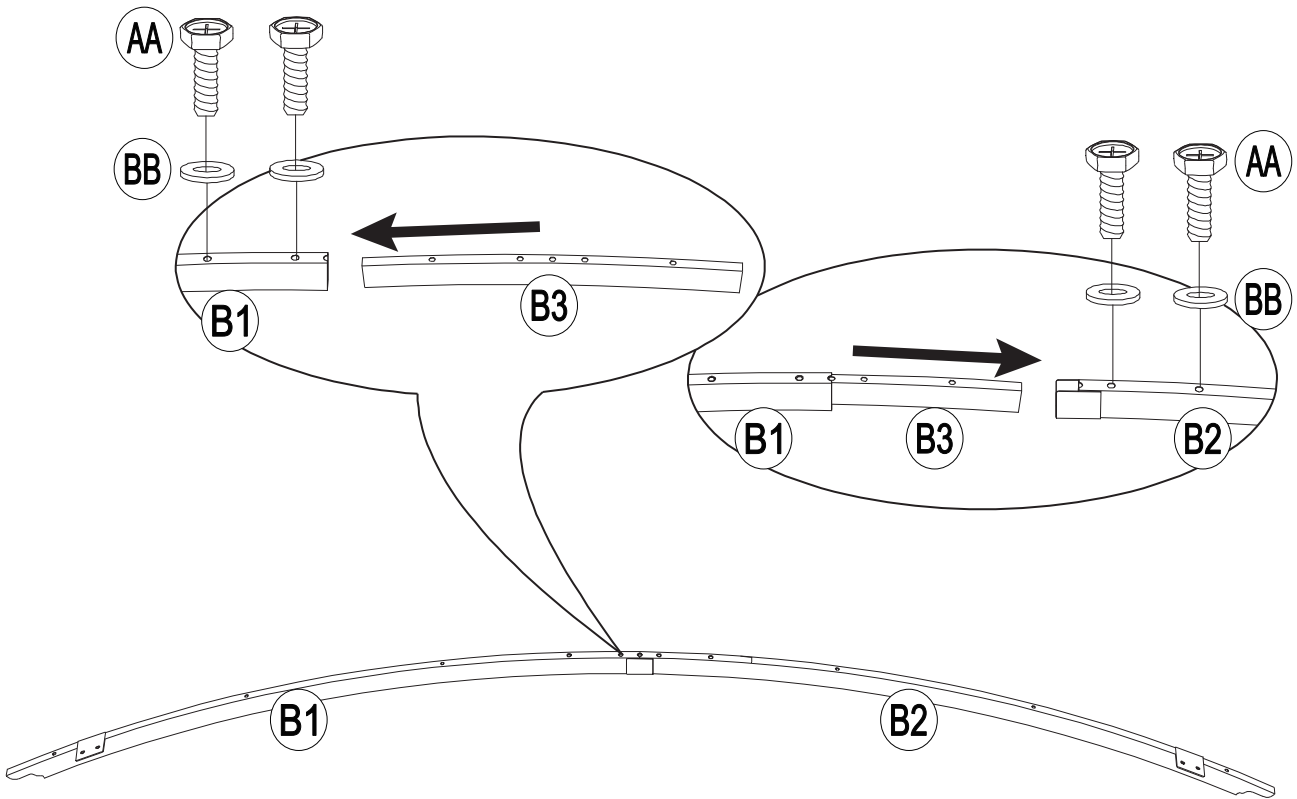
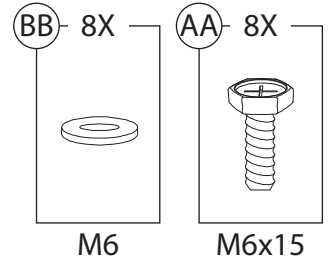
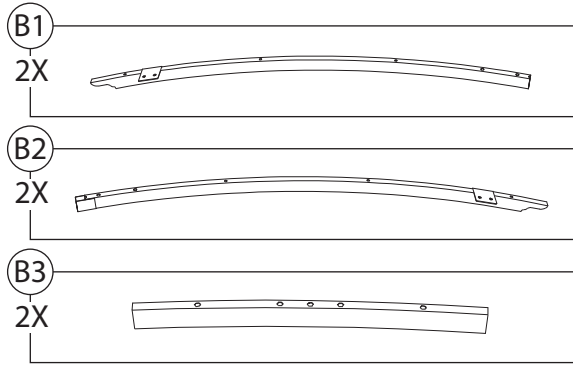

Step 6

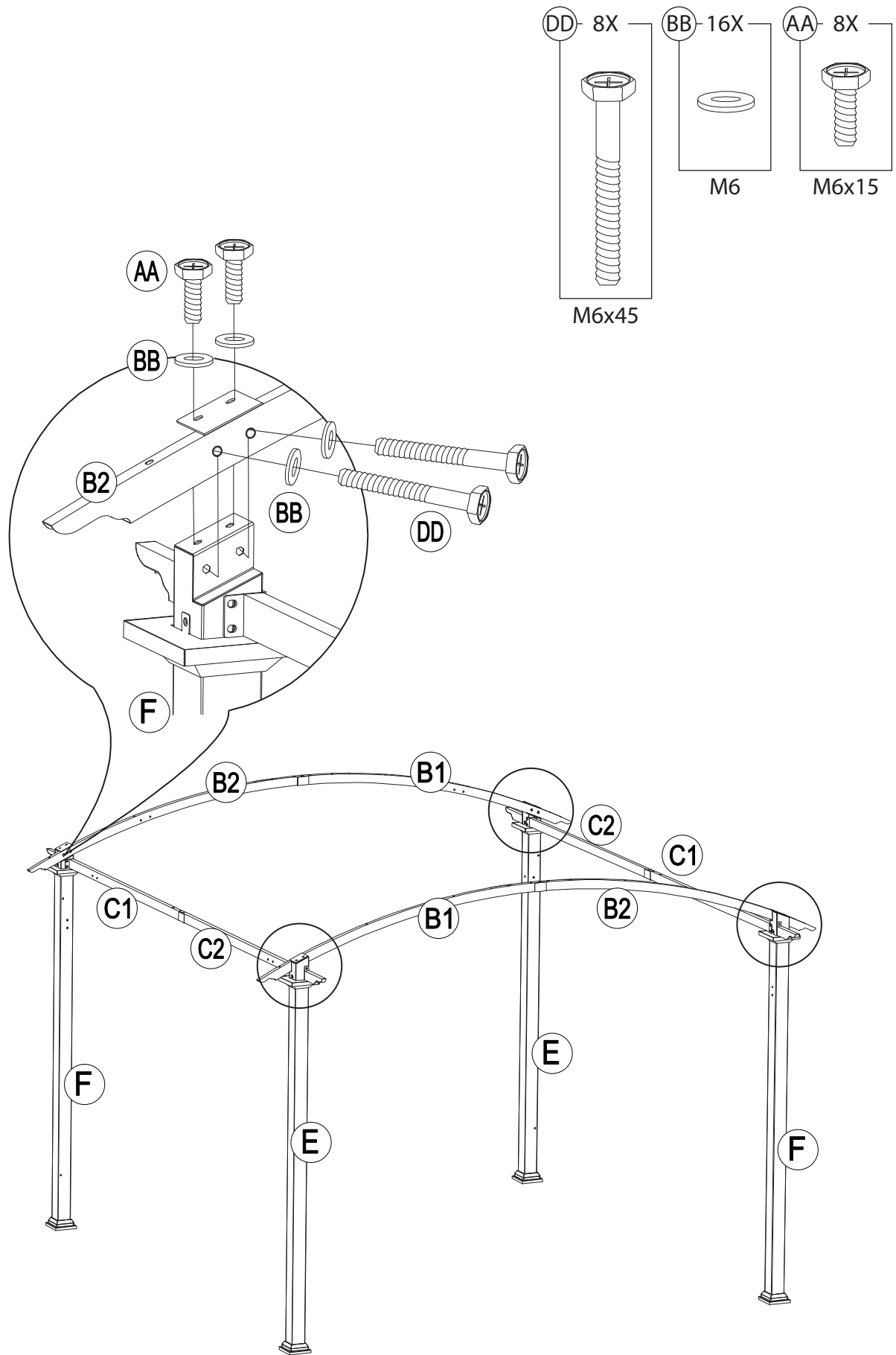

Step 7

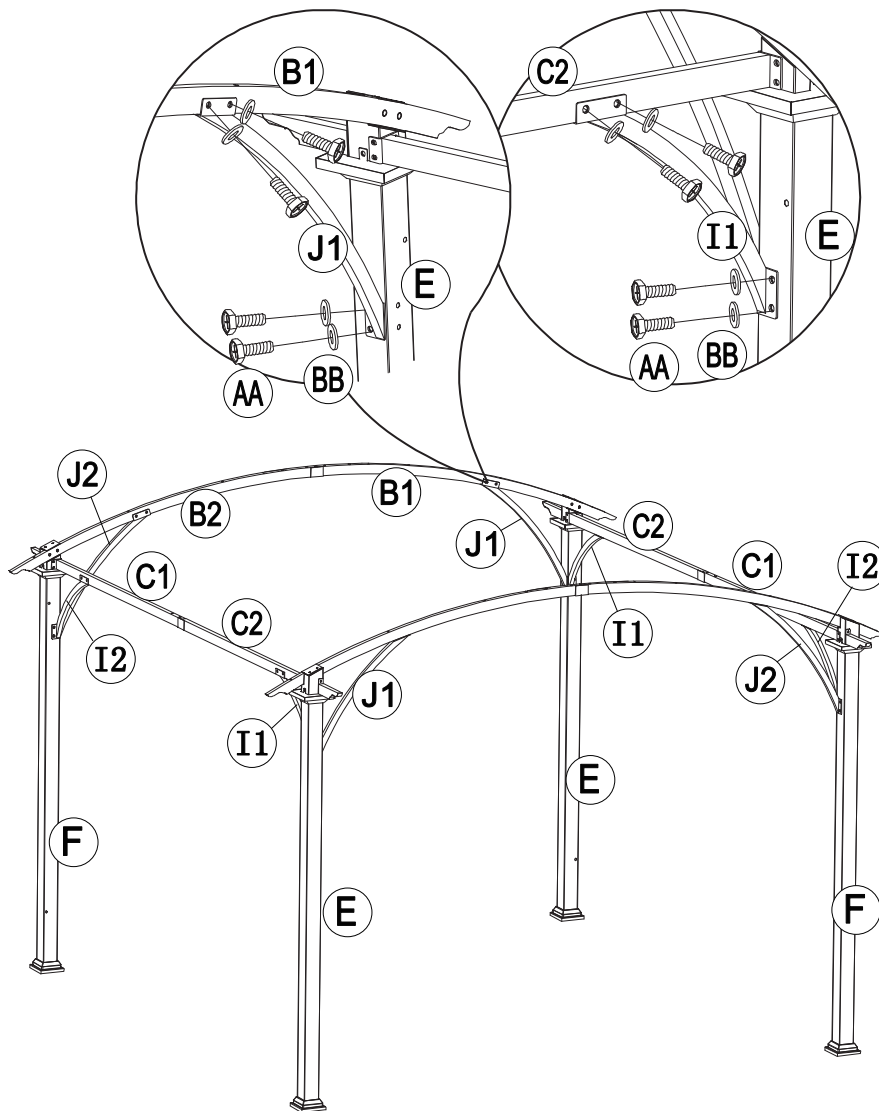
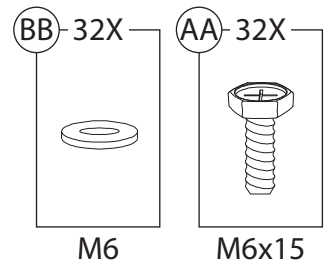
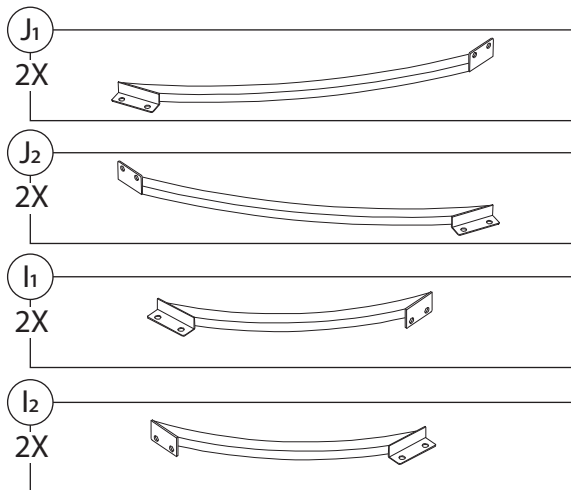

Step 8

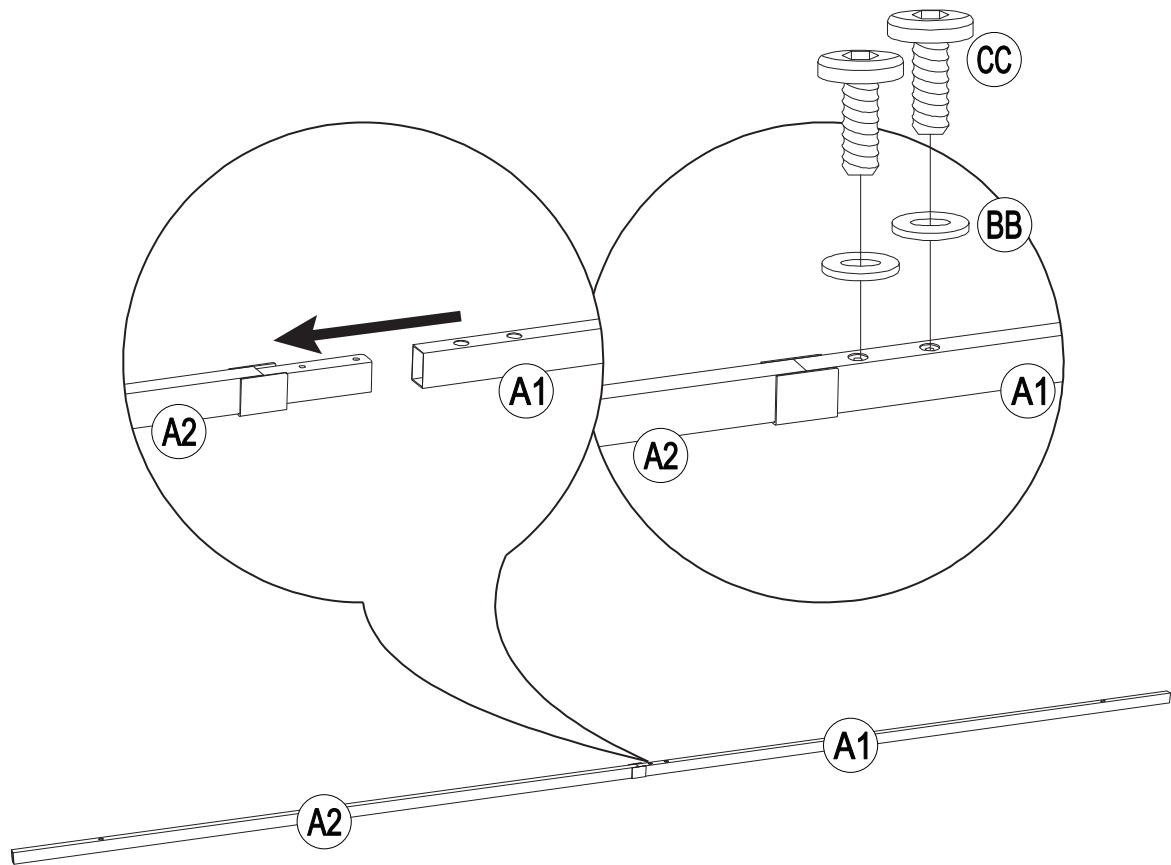
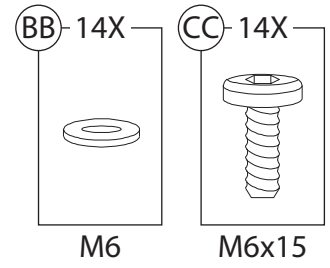
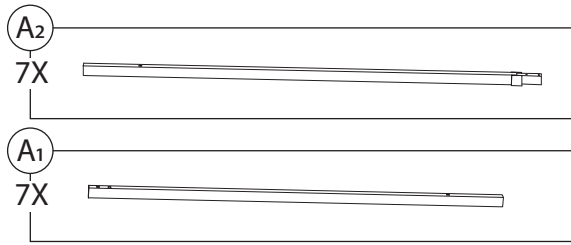

Step 9

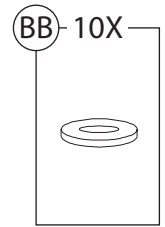
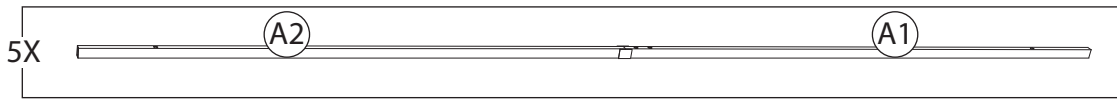

M6

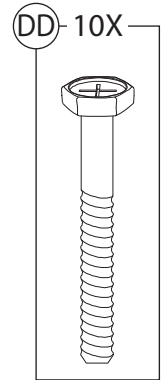

M6x45

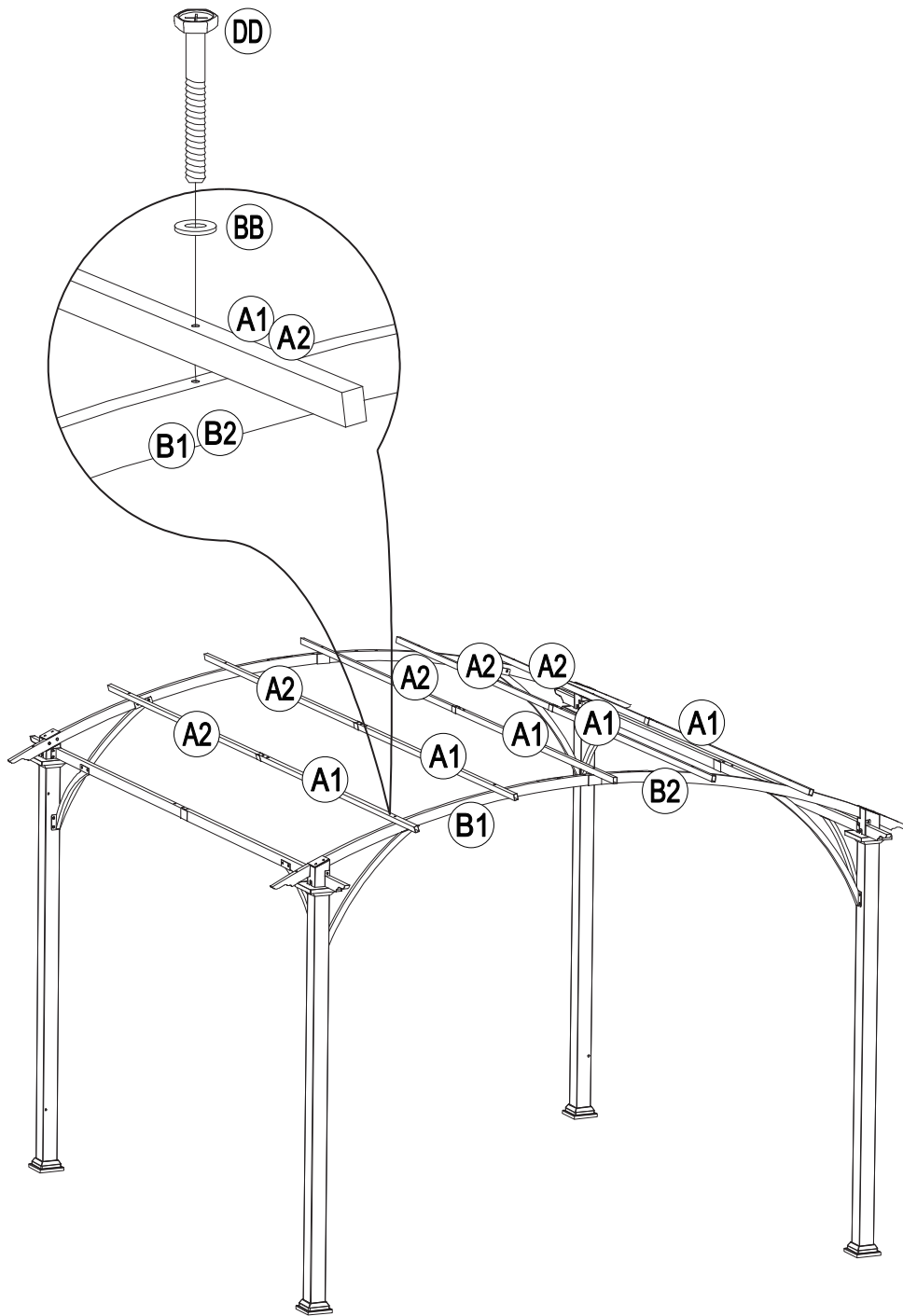

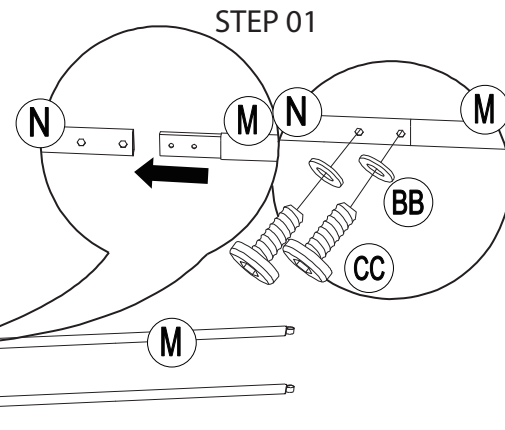
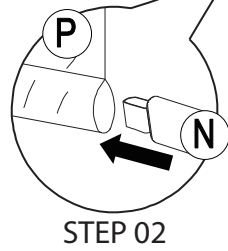
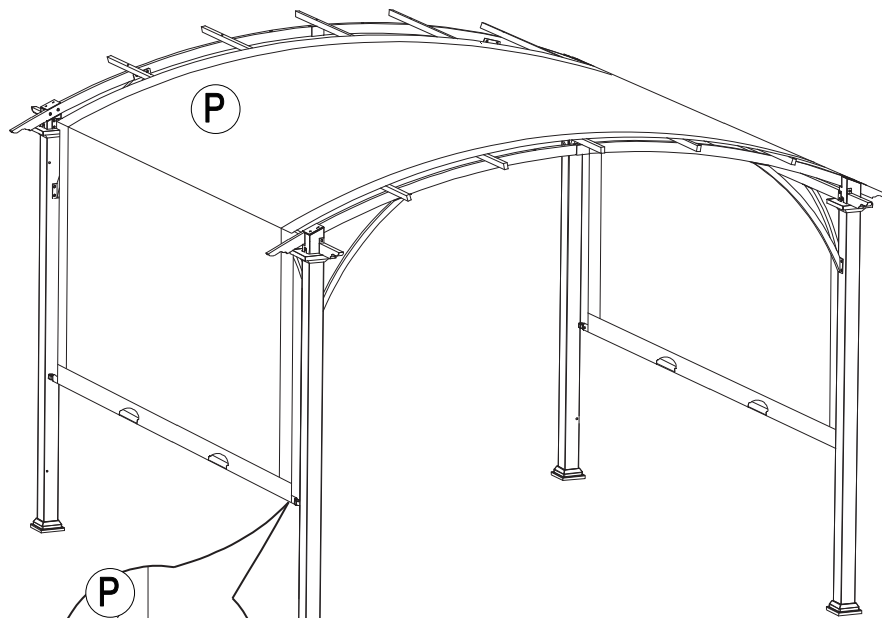
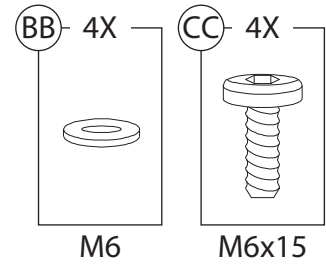
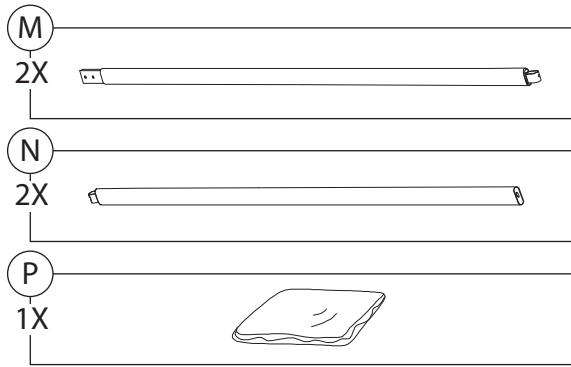

Step 10

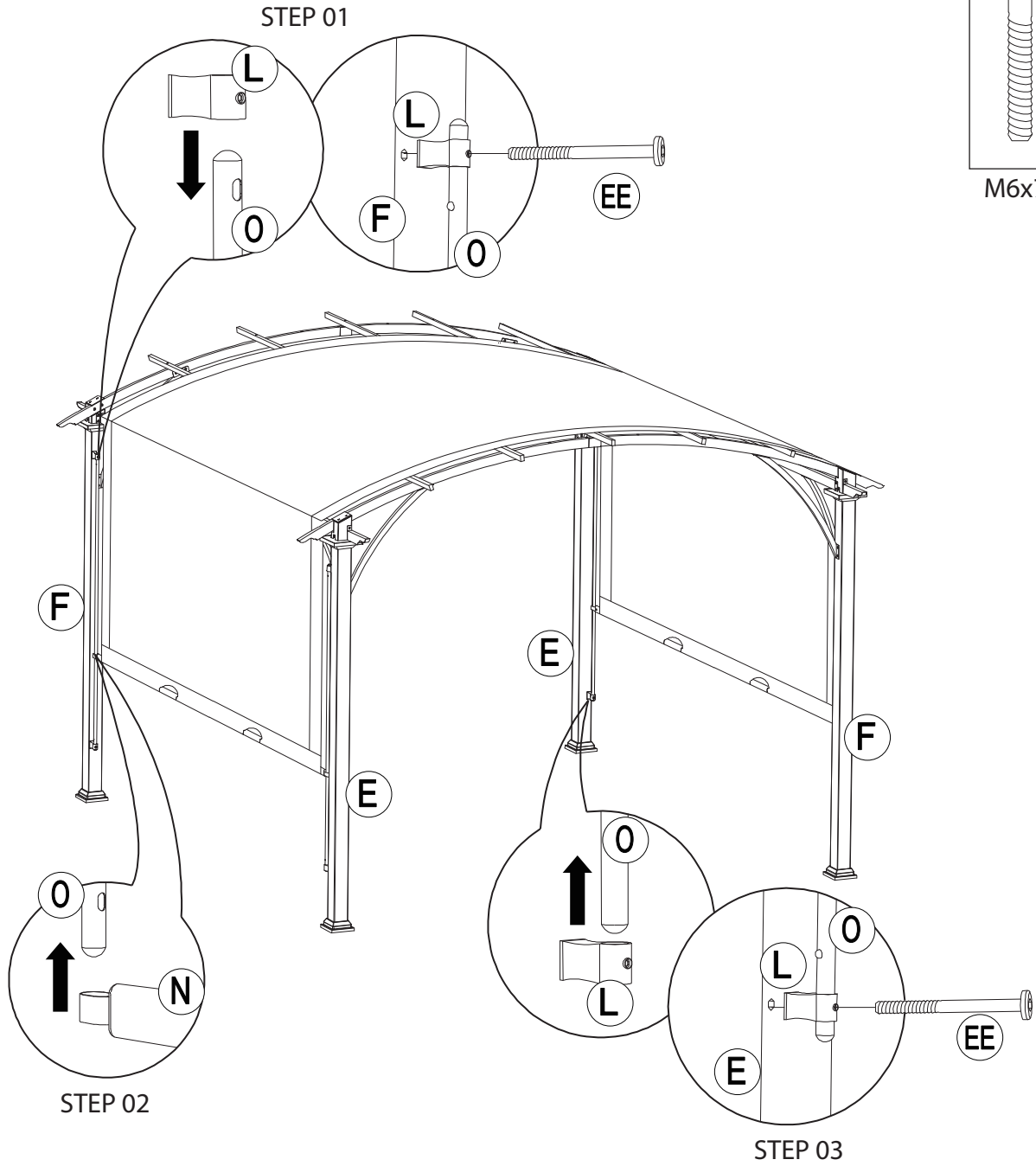
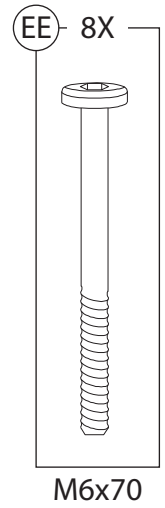
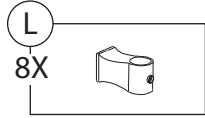
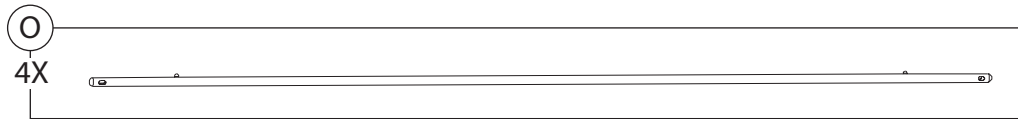

Step 11

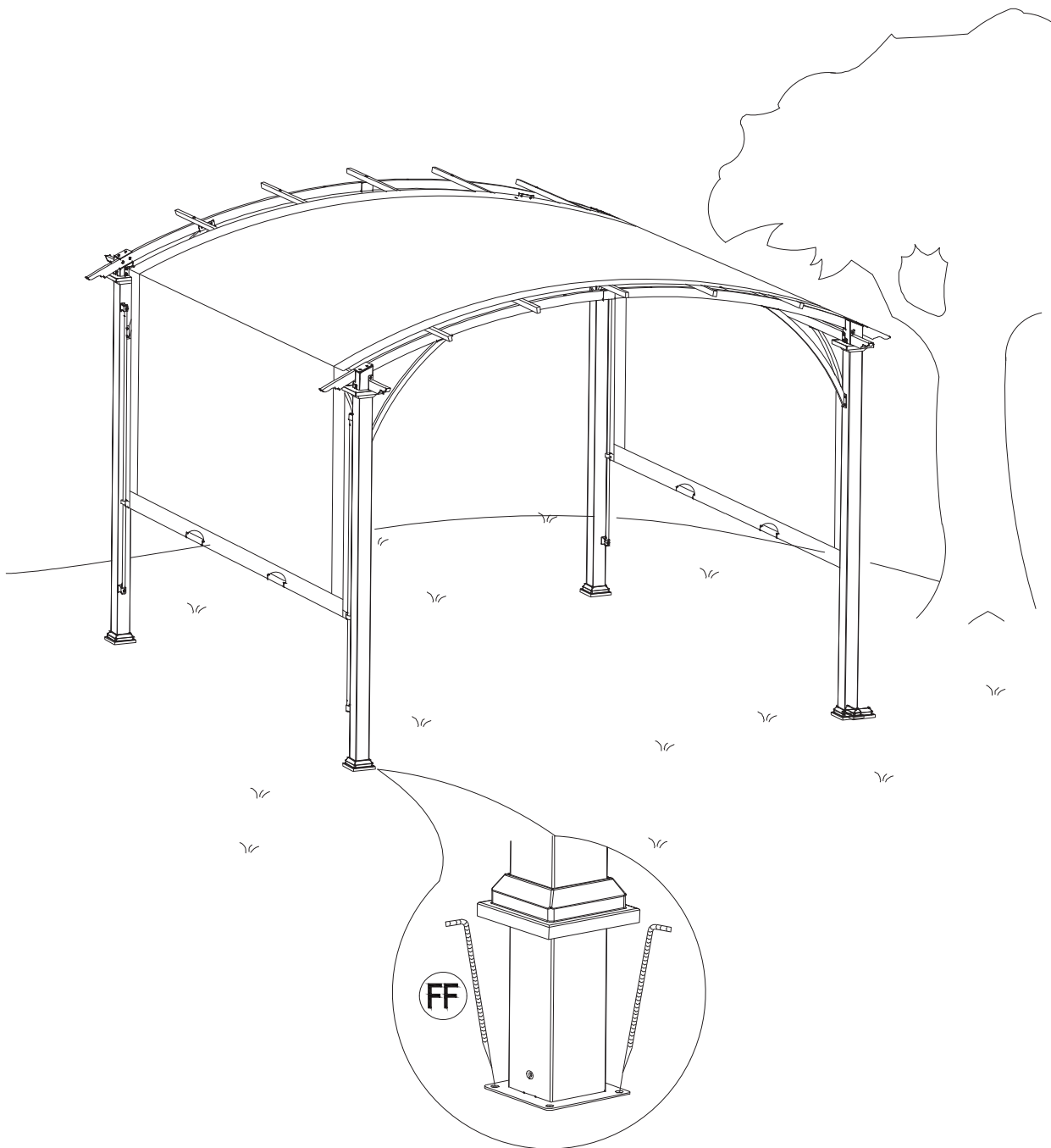
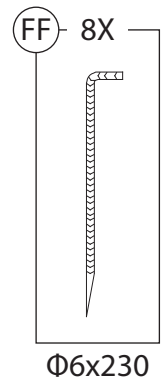

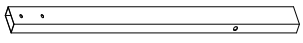
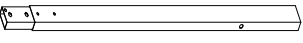
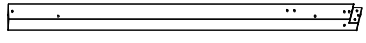
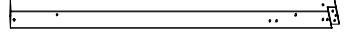
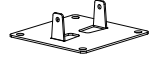

BOX CONTENTS		BOX1/2
Label	Sketch	QTY
A1		5 pcs
A2		5 pcs
E		2 pcs
F		2 pcs
G		4 pcs
H		4 pcs

