

# ASSEMBLY INSTRUCTIONS.

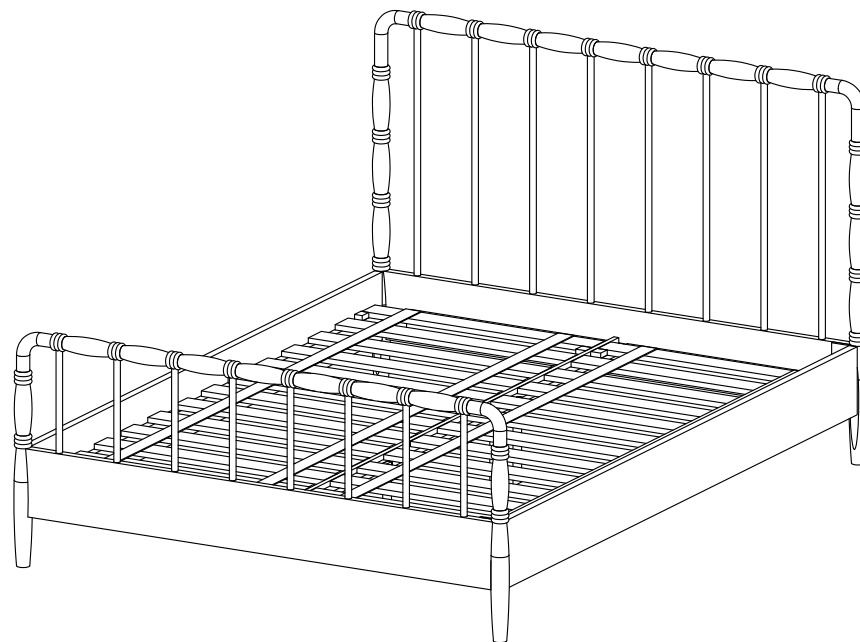





QUEEN BED





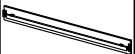

THANK YOU FOR YOUR PURCHASE!

# PARTS AND HARDWARE.

## PARTS LIST

NO.	DESCRIPTION	IMAGE	Q'TY
P1	HEADBOARD		1
P2	FOOTBOARD		1
P3	SIDE RAIL		2
P4	CENTER RAIL		1
P5	SUPPORT LEG		2
P6	SLATS		2

## HARDWARES LIST

NO.	DESCRIPTION	IMAGE	QTY
H1	HEX BOLT (10x20 mm)		8
H2	HEX BOLT (10x100 mm)		2
H3	WASHER		4
H4	NUT		2
H5	SPANNER		1

## NOTES.

Thank you for purchasing this quality product! Be sure to check all packing material carefully for small part that may have come loose inside the carton during shipping.

**CAUTION:** The item is heavy, assembly should be performed by two people.

## STEP 1.

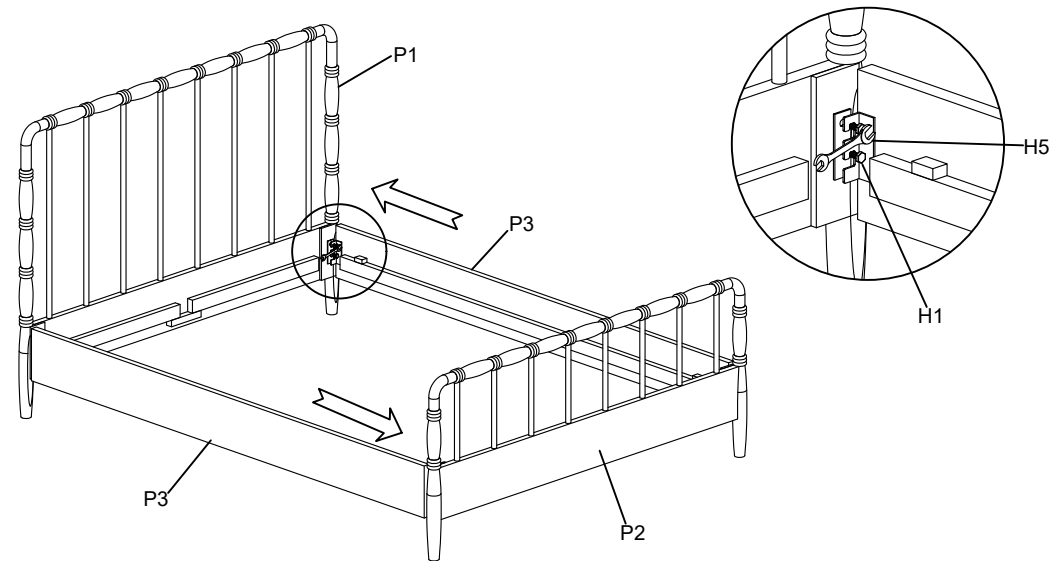



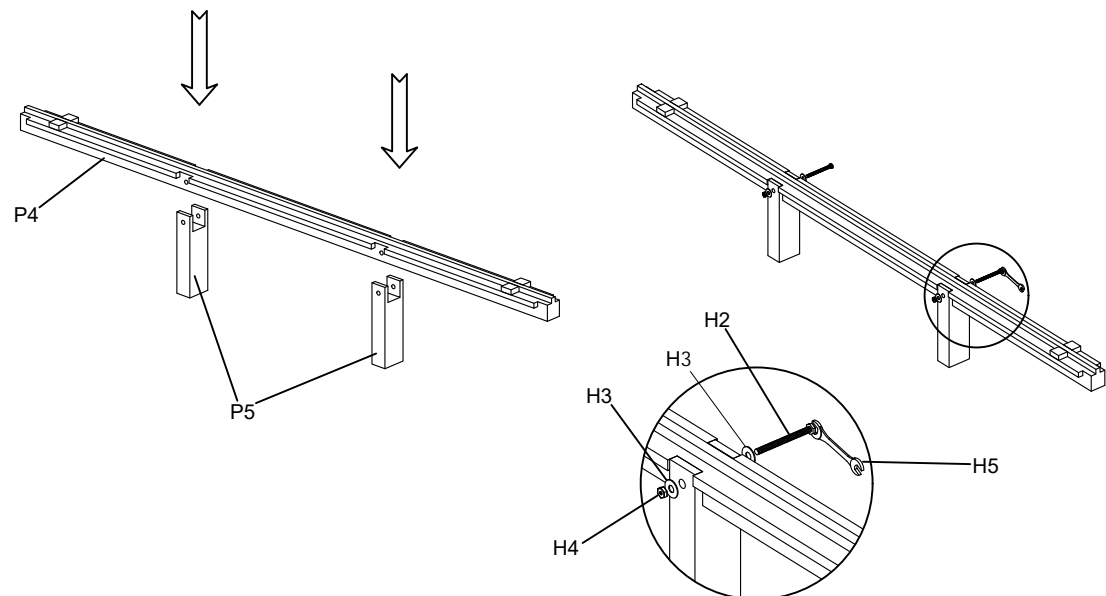



## STEP 2.



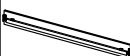



## PARTS AND HARDWARE.

### PARTS LIST

NO.	DESCRIPTION	IMAGE	Q'TY
P1	HEADBOARD		1
P2	FOOTBOARD		1
P3	SIDE RAIL		2
P4	CENTER RAIL		1
P5	SUPPORT LEG		2
P6	SLATS		2

### HARDWARES LIST

NO.	DESCRIPTION	IMAGE	QTY
H1	HEX BOLT (10x20 mm)		8
H2	HEX BOLT (10x100 mm)		2
H3	WASHER		4
H4	NUT		2
H5	SPANNER		1

### NOTES.

Thank you for purchasing this quality product! Be sure to check all packing material carefully for small part that may have come loose inside the carton during shipping.

**CAUTION:** The item is heavy, assembly should be performed by two people.

STEP 3.

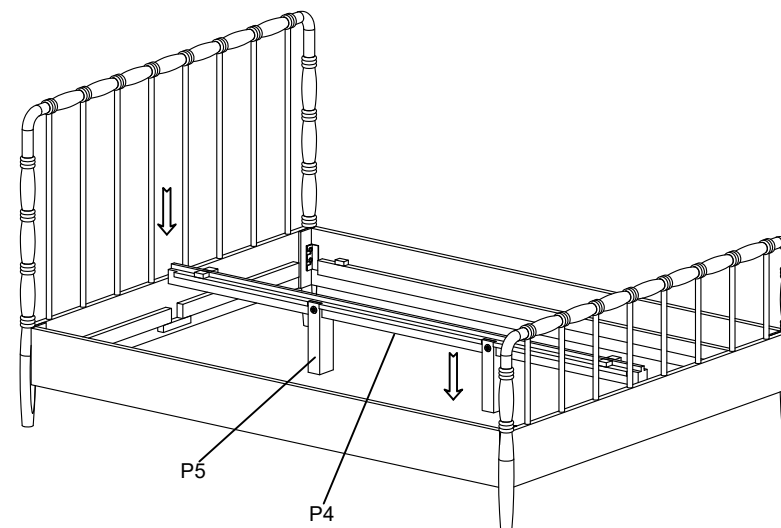

STEP 4.

