

Before you begin, please read Page 2 of "Assembly and Care Advice".

And remember, do not tighten until each step is completed or instructed.

Parts List

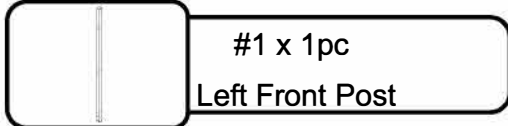

#1 x 1pc
Left Front Post

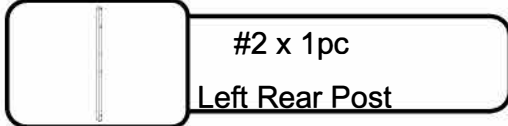

#2 x 1pc
Left Rear Post

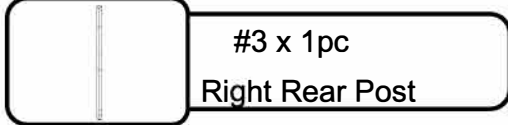

#3 x 1pc
Right Rear Post

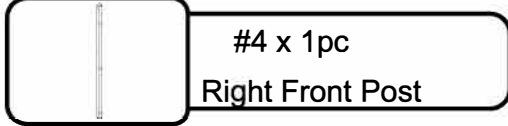

#4 x 1pc
Right Front Post

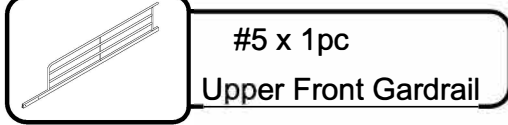

#5 x 1pc
Upper Front Gardrail

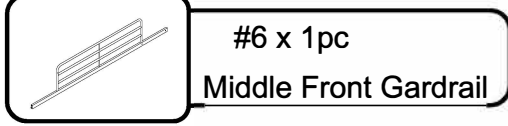

#6 x 1pc
Middle Front Gardrail

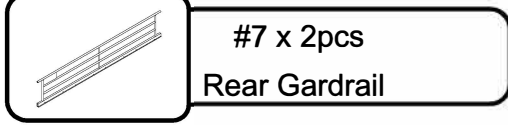

#7 x 2pcs
Rear Gardrail

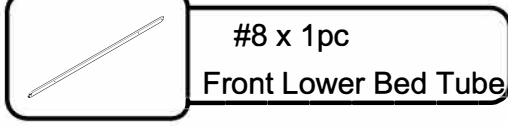

#8 x 1pc
Front Lower Bed Tube

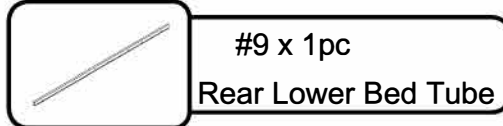

#9 x 1pc
Rear Lower Bed Tube

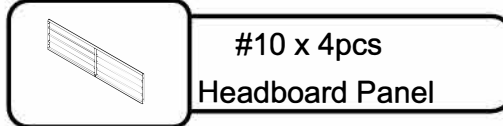

#10 x 4pcs
Headboard Panel



#11 x 2pcs
Lower Frame

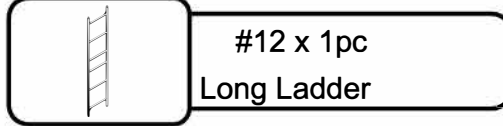

#12 x 1pc
Long Ladder



#13 x 1pc
Short Ladder



#14 x 6pcs
Side Bed Base

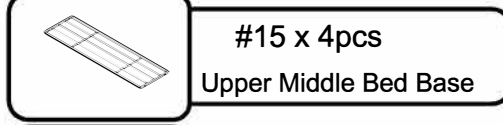

#15 x 4pcs
Upper Middle Bed Base

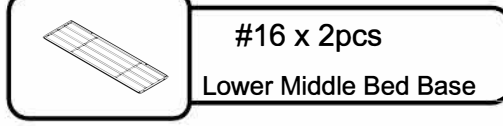

#16 x 2pcs
Lower Middle Bed Base

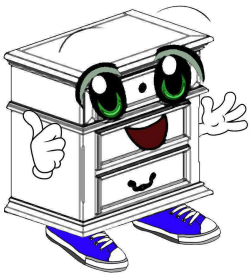

Before you begin, please read Page 2 of "Assembly and Care Advice".

And remember, do not tighten until each step is completed or instructed.

Parts List

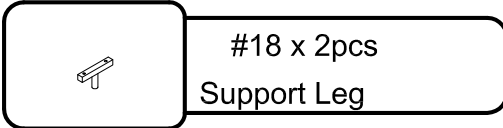
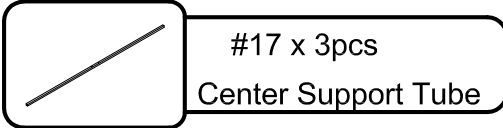

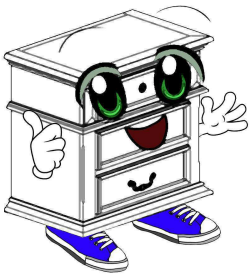

Before you begin, please read Page 2 of "Assembly and Care Advice".

And remember, do not tighten until each step is completed or instructed.

Hardware List



#A x 16pcs
Bolt 1/4"x 5/8"



#B x 52pcs
Bolt 1/4"x 1"



#C x 6pcs
Bolt 1/4"x 1-1/8"



#D x 15pcs
Bolt 1/4"x 1-3/8"



#E x 13pcs
Bolt 1/4"x 3"



#F x 24pcs
Bolt 1/4"x 3"



#G x 2pcs
Screw M4x37



#H x 4pcs
Metal Plate



#I x 2pcs
Bracket



#J x 2pcs
Girding



#K x 1pc
Allen Wrench M4

Exploded View

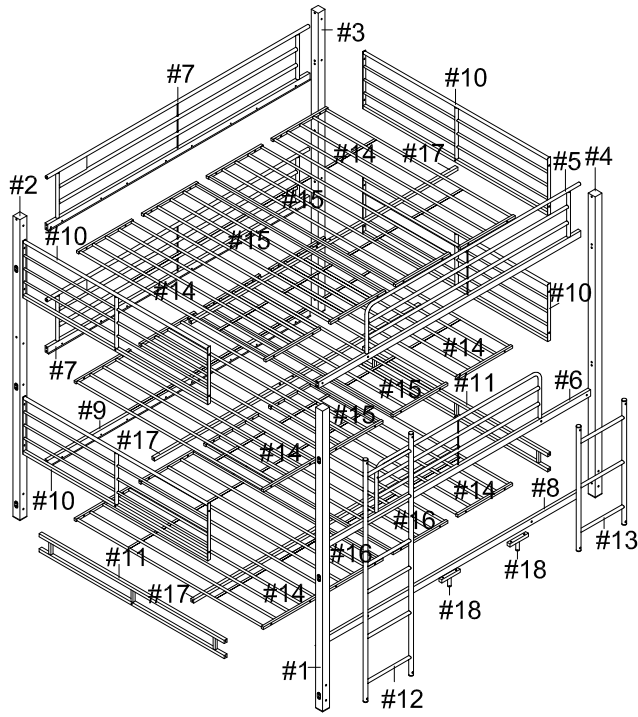

#A x 16pcs
#E x 8pcs

2) Align headboard panels (#10) to the holes of the posts (#1,2,3,4).
Secure by using bolts (#A).

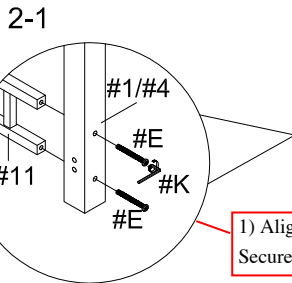
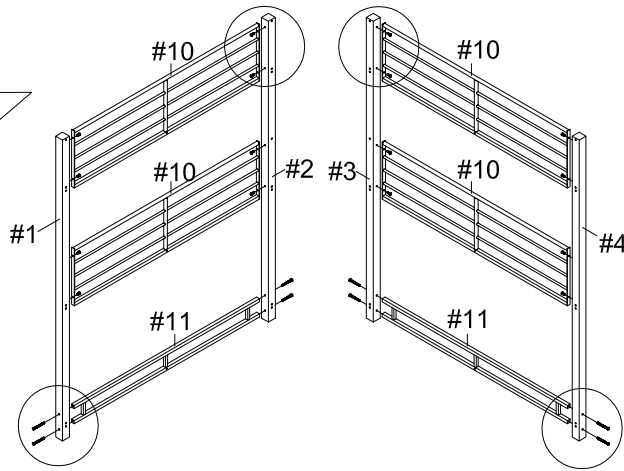
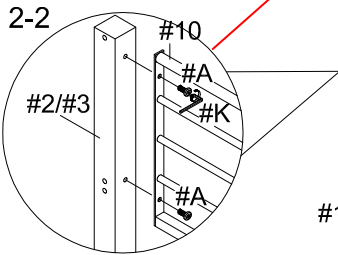

1) Align lower frame (#11) to the holes of the posts (#1,2,3,4).
Secure by using bolts (#E).



#E x 5pcs
 #F x 24pcs
 #H x 2pcs

2) Align guardrails (#5,6,7) to the holes of the headboards, then secure by using bolts (#E,F) as shown in the picture.

3-2

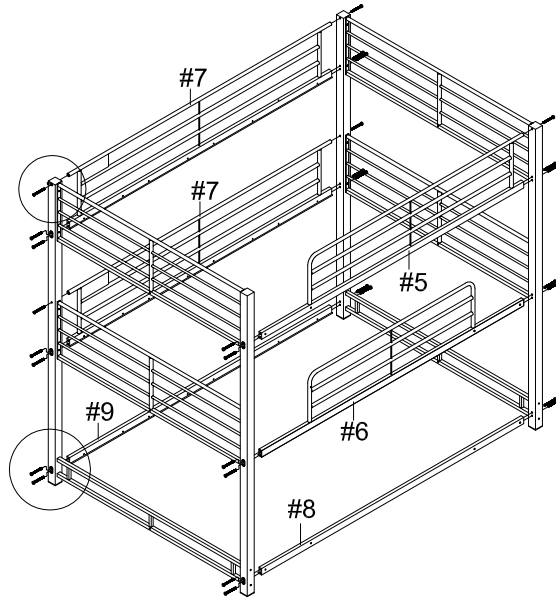
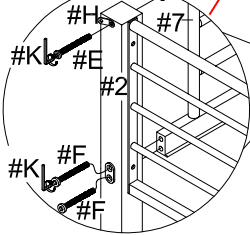

3-1

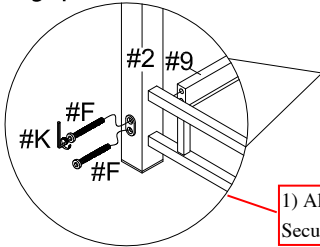

1) Align lower tubes (#8,9) to the holes of the headboards. Secure by using bolts (#F).



#B x 48pcs
 #C x 6pcs
 #D x 6pcs

2) Align slats (#14,15) to the holes of the top and middle bunks, then secure by using bolts (#B). Align slats (#14,16) to the holes of the bottom bunk, then secure by using bolts (#B).

4-2

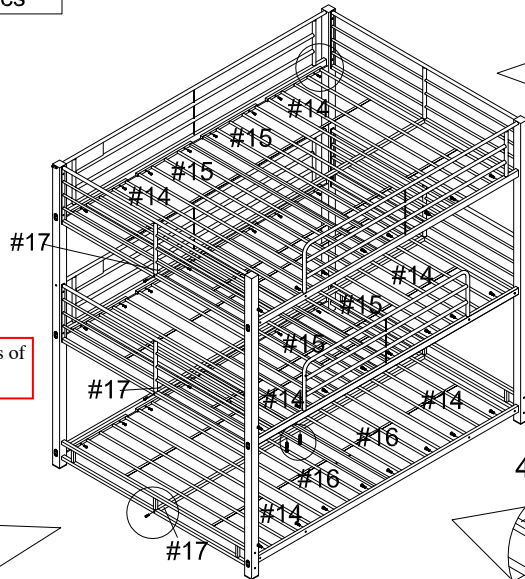
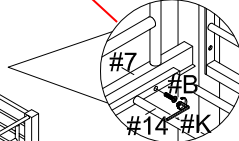

1) Align center support tubes to the holes of each bunks. Secure by using bolts (#D).

4-1

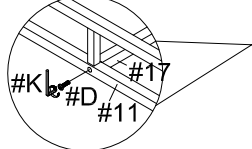

4-3

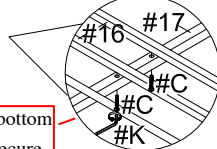

3) Secure center support tube (#17) from bottom bunk to the holes of the slats (#16), then secure by using bolts (#C).



#B x 4pcs
#D x 9pcs

3) Align shorter ladder (#13) to the holes of the bunk bed, then secure by using bolts (#D).

5-2

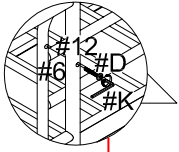

1,2) Align long ladder (#12) to the holes of the bunk bed, then secure by using bolts (#D) as shown in the picture.

5-1

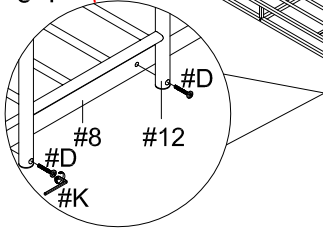

5-3

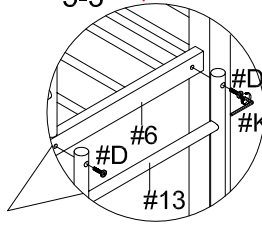

5-4

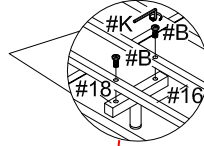

4) Align support legs (#18) to the lower bunk holes, then secure by using bolts (#B).

ASSEMBLY COMPLETED

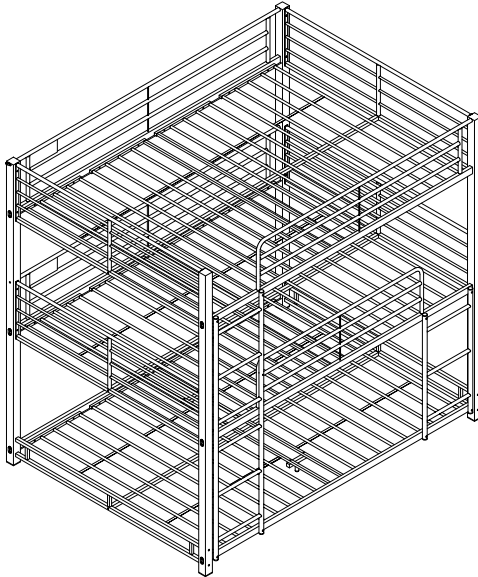



#G x 2pcs
 #H x 2pcs
 #I x 2pcs

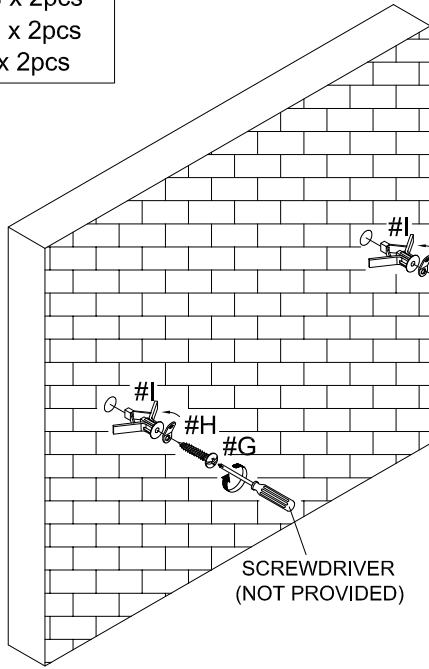

SCREWDRIVER
 (NOT PROVIDED)

SCREWDRIVER
 (NOT PROVIDED)



#J x 2pcs

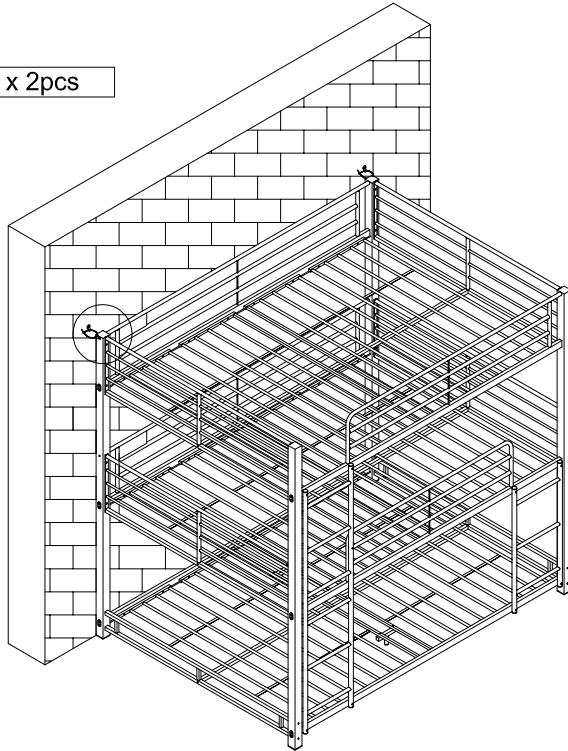

To Prevent Tip over
 Product Must Be
 Attached To Wall

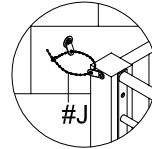

Safety Warnings

1. Follow the information on the warnings appearing on the upper bunk end structure and on the carton . Do not remove warning label from bed.
2. Always use the recommended size mattress or/and mattress support to help prevent the likelihood of entrapment or falls.
3. Surface of mattress must be at least 5 in. below the upper edge of guardrails .
4. Do not allow children less than 6 years of age to use the upper bunk.
5. Periodically check and ensure that the guardrail, ladder ,and other components are in their proper position ,free from damage ,and that all connectors are tight .
6. Prohibit horseplay on/or under the bed and prohibit jumping on the bed.
7. Always use the ladder for entering and leaving the upper bunk.
8. Do not use substitute parts ,Contact manufacturer or dealer for replacement parts.
9. Use of a night light may provide added safety precaution for a child using the upper bunk.
10. Always use guardrails on both long sides of the upper bunk.
11. If the bunk bed will be placed next to a wall, the guardrail that runs the full length of the bed should be placed against the wall to prevent entrapment between the bed and the wall.
12. The use of water or sleep flotation mattress is prohibited .
13. Keep these instructions for future reference.
14. Use only mattress which is 74 3/4"x54" x5" on upper bunk and for bottom bunk required 74 3/4"x54" x5"mattress.
15. Prohibit more than one person on upper bunk.

STRANGULATION HAZARD:

16. Never attach or hang items to any part of the bunk bed that are not designed for use with the bed for example, but not limited to hooks, belts, and jump ropes.